

# DIGITAL YACHT



## NEXT GENERATION MARINE ELECTRONICS



SAIL BOAT



MOTOR BOAT



SUPERYACHT



WORK BOAT



SPORT FISHING



COMMERCIAL FISHING



# CONTENTS

- 1** WELCOME TO DIGITAL YACHT
- 2** AUTOMATIC IDENTIFICATION SYSTEMS
- 11** NAVIGATION
- 15** iPad AND TABLET NAVIGATION
- 18** MARINE PCs
- 20** ONBOARD NETWORKING
- 23** INTERNET CONNECTIVITY
- 26** AIS FOR SAFETY
- 28** ONBOARD ENTERTAINMENT
- 30** DIGITAL YACHT SOLUTIONS
- 35** DIGITAL DEEP SEA
- 37** OUR IDEAS FOR YOU

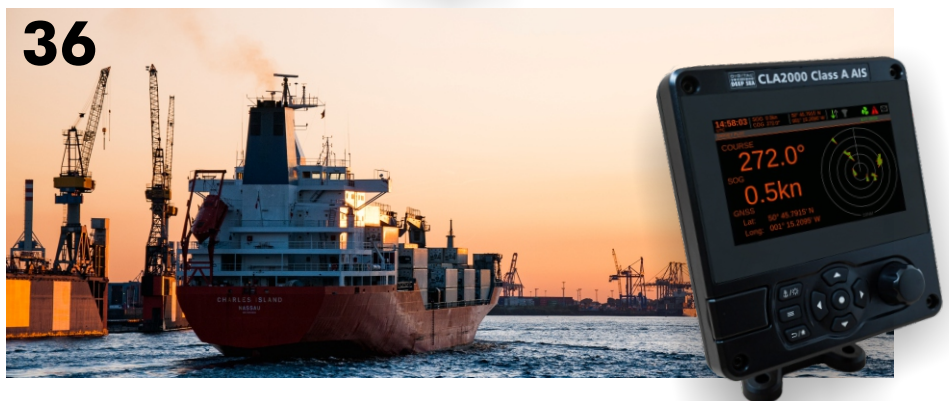



# WELCOME...

**DIGITAL YACHT IS ALL ABOUT NEXT GENERATION NAVIGATION, COMMUNICATION AND ENTERTAINMENT SYSTEMS FOR YOUR BOAT**

**BOATING SHOULD BE FUN, SAFE AND EASY AND OUR PRODUCTS INTEGRATE INTO EXISTING AND NEW BOAT NETWORKS TO BRING A POWERFUL DIMENSION TO YOUR ONBOARD ELECTRONICS**



We firmly believe that low cost consumer devices such as iPhones and tablets, PCs and MACs have a place on board and can help make legacy systems compete with the latest in dedicated marine electronic products at a fraction of the cost. We make internet access whilst afloat easy and affordable as well as bringing all your navigation data to your favourite consumer devices - not just for you but for crew and guests too.

Our navigation systems cover advanced GPS and compass technology as well as the most comprehensive range of AIS products in the marketplace. Plus our PC and software solutions bring simple yet powerful solutions to a variety of on board requirements from communication to navigation, entertainment to monitoring.

Our design team has 100's years combined experience in marine electronic systems and we take pride in our quality heritage with manufacturing in the UK and global reach with offices in the US and UK. Last year our products were sold in over 100 countries worldwide.

Good Boating,  
**The Digital Yacht Team**



# AIS

## AUTOMATIC IDENTIFICATION SYSTEM

Automatic Identification System (AIS) is the name given to an international maritime communications protocol developed back in the late 90s. It's defined in a series of formal documents issued by the ITU and IEC, and managed by the IMO and it enables the accurate and reliable identification and tracking of vessels.

AIS uses GPS and VHF radio technologies to automatically communicate between vessels allowing vessel identity, position, course and speed (and other data) to be shared to other AIS users within range. These could be vessels, aircraft, coast stations or satellites. A single AIS transmission (message) can contain up to 27 pieces of information and can be used to carry numerous different types of data.

AIS is a MESH network using real-time data communications technology. The IMO developed the standard to minimise the risk of collisions in the ocean when vessels may be out of range of any land based system so it can't rely on a central network.

In 2002, AIS was mandated by the IMO in a SOLAS agreement for all international vessels over 300GRT worldwide. This created AIS as a ubiquitous communications standard with the AIS VHF transmit frequency(s) allocated and approved in all IMO member countries.

### BENEFITS OF AIS

AIS forms an important part of a toolbox of aids to navigation. Information received via AIS can supplement and improve radar information and therefore is a valuable aid to assist in collision avoidance. It's affordable, easy to install and also easier to interpret for leisure users compared to small radar systems.

Although AIS cannot replace radar, which is, in many ways, a 'complete' system, the key benefit over radar is automatic vessel identification allowing the identity of a vessel to be established – ideal for voice and DSC inter-ship communications to establish a manoeuvre. AIS also transmits heading, course over ground (COG) and speed over ground (SOG) which is much more accurate than using a ARPA (automatic radar plotting aid) on a radar system. It also provides automatic provision of CPA (Closest Point of Approach) and Time to Closest Point of Approach (TCPA) for a target. Disseminating information from an AIS overlay on a chart plotter display is generally much easier than from a radar display.

With AIS signals there is no loss or targets in degradation of sea, rain and snow conditions and it will generally give extended ranges with the ability to provide information in radar shadow areas

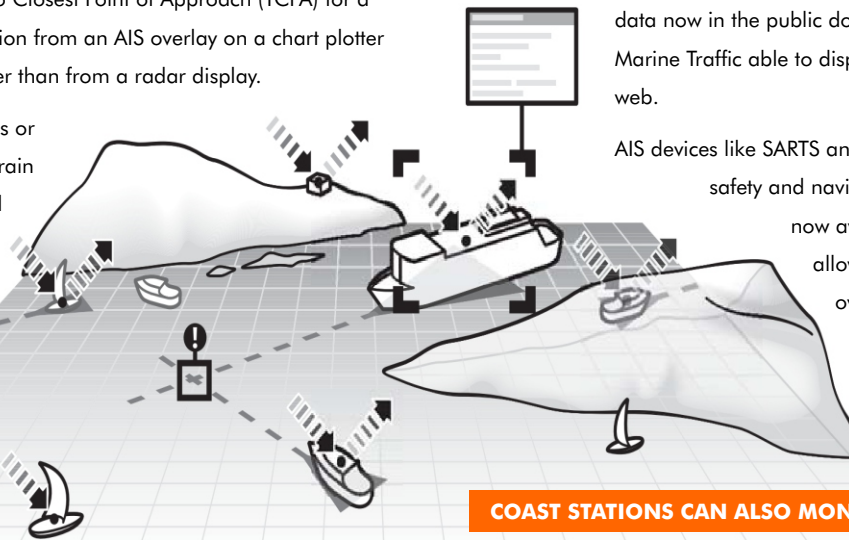

COAST STATIONS CAN ALSO MONITOR AIS ACTIVITY



(it can see around bends and behind islands which can be vital for inland waterways traffic). Leisure users who enjoy social boating like being able to track "boating buddies" and competitive yachtsmen can use AIS for race tracking and safety.

AIS also provides extensive security benefits for port authorities and marine domain monitoring. There is now an extensive network of shore based monitoring stations providing information for safety and surveillance. This is augmented by satellite tracking too which is in its infancy. There is a lot of AIS data now in the public domain with popular websites like Marine Traffic able to display ship and boat target data over the web.

AIS devices like SARTS and ATONs have also created a new safety and navigation category with compact AIS PLBs now available for life vest integration allowing an automatic indication of a man over board (MOB).



## TYPES OF AIS

An AIS which sends and receives data is known as a transceiver (or often called a transponder). There are also simple devices called AIS receivers which pick up transmissions and decode for displaying on a compatible chart plotter or PC based navigation system – or even an iPad or tablet.

The main formats for an AIS Transponder are Class A or Class B. Class A and Class B devices are interoperable – ie; a Class A device can see a Class B and vice versa.

A Class A device must have a dedicated (and type approved) display to show the location of nearby AIS targets and transmits at 12.5W. Data is sent at up to every 2 seconds depending upon the vessel speed and the display also allows for data to be inputted to the transmission such as vessel destination. A Class A device is normally used on commercial vessels as its Type Approved to IMO specifications. It will also be connected to the ship's ECDIS or chart plotter system to provide an overlay of targets.

A Class B device is a simplified, lower powered 2W transceiver which is normally a black box and uses a connected chart plotter to display local AIS targets. It transmits every 30 seconds regardless of vessel speed and can't transmit additional data like destination port.

Both Class A and Class B devices are using GPS and VHF radio technologies so require a GPS sensor and antenna for the VHF transmissions and reception. A Class B device always has the GPS embedded and requires connection to a suitable VHF antenna or a specialised VHF-AIS antenna splitter. A Class A device will normally utilise its internal GPS but has the option to connect to the ships external sensors if required. It must have a dedicated VHF antenna for operation.

Class B+ is a new standard that utilises SOTDMA format transmissions which offer a 5W power output (2.5 x more powerful than a regular Class B), a guaranteed time slot for transmission in busy traffic areas and faster update rates depending upon the speed of the vessel. It's ideal for ocean sailors requiring the best possible performance and future proof satellite tracking applications, fast power boats and smaller non-mandated commercial vessels. It still inter-operates with existing Class B and Class A systems.



## ATON: AIS AIDS TO NAVIGATION

An AIS transceiver specifically for use on marine infrastructure and buoys to provide real time hazard alerts as well as live monitoring data such as weather, sea and lantern status. ATON transmissions can be displayed on compatible chart plotter and ECDIS systems and allow a buoy or structure to be positively identified as well as the ability to display local wind, tide or metrological data. Two different types of ATON are defined by the AIS standards: Type 1 and Type 3. Both transmit at up to 12W power and use either FATDMA or SOTDMA access protocol. Those that receive signals. Type 1 devices transmit only through pre-programmed reserved time slots. Type 3 devices can send and receive through SOTDMA.

## SART: SEARCH AND RESCUE TRANSPONDER

An AIS SART (Search And Rescue Transmitter) is a homing beacon designed for use in an emergency. When activated an AIS SART transmits its GPS position using AIS in a special SART message. This message is recognised by the AIS display systems on other vessels (and potentially on shore) as an emergency message and generates an alarm. An AIS SART can be used to locate a life raft or lifeboat in an emergency situation. Available in vessel versions (SART) or personal versions (PLB) with the difference being size and range. These devices transmit at up to 2W power using RATDMA access protocol. An AIS SART with its position close to the waterline and limited 2W output would typically have a maximum range of 5-6NM. A PLB device would typically have a range of 2-3NM.



**MOB100 is an ultra compact AIS MOB beacon/SART, designed for manual or auto activation from a life jacket.**



# CAN THEY SEE YOU?

28 KNOTS, 171000 TONS, 2 MILES TO STOP, FOG, DARK?



## AIS BASE STATIONS

AIS base stations are fixed (non-mobile) stations that port authorities use to monitor and control vessel traffic. Major ports and harbours install these systems to give additional control over local AIS users. These base stations can also control other AIS devices with the ability to turn other AIS devices on or off, reserve time slots for special transmissions, control which time slots mobile AIS devices use and even control the power level of AIS transponders.

## SPOOFING AND ERRORS FROM AIS

Of course, an AIS can be turned off or the transmission muted. In fact, most Class B products have this functionality enabled and it's good practice to enable on a leisure vessel when at anchor or port in congested waters. Commercial ships should always maintain their AIS transmissions even when at anchor and take instructions from a port as to local requirements. If an AIS is turned off or muted for anti piracy requirements then a note should be made in the ship's log.

There have also been reports of AIS spoofing where inaccurate data and false position information is fed into an AIS system. This effectively makes for a false target in a false location but this activity would be criminally liable.

Another issue is that the AIS unit may not be installed in accordance with the IMO Guidelines. This can mean heading information from a vessel is incorrect or the static data has been incorrectly entered making a sailing vessel the size of a tanker!

## RANGE FOR AIS SYSTEMS

AIS uses VHF radio frequencies to transmit data so range is limited to line of sight and typically is similar to a regular VHF radio transmission. In practice, this means Class A products have a maximum range of around 30-50NM whereas lower powered 2W Class B devices have a maximum range of 10-20NM. In some areas there are shore based AIS repeaters. Height of the antenna is critical for the best possible range (much more so than power output of the transponder) but range isn't everything with an AIS transmission and in fact too many signals can cause problems with the ability of a plotter to display data. Remember that every collision happens at zero feet so trying to get maximum range may not be the most important aspect.

For information, the distance (in NM) from an antenna to the horizon can be calculated using the approximate formula (where h is the height of the antenna in feet):

$$d = 1.225 * \sqrt{h}$$

So as an example, a sail boat with a 64ft mast, the maximum theoretical range would be 9.8NM. If the signal is being picked up by another sailboat with a similar installation on the other side of the horizon then the range would effectively double to nearly 20NM.



### AIS SYSTEMS - WHAT DYNAMIC DATA IS AVAILABLE?

#### Dynamic Data:

This is information such as vessel position and speed automatically calculated by the transponder. A Class B unit sends dynamic data every 30 seconds when moving at speeds above 2 knots. Below 2 knots, data is only sent every 3 minutes.

Dynamic data sent includes position, course and speed and heading information if available from an external sensor. A Class A system can also transmit navigational status and rate of turn (ROT) information if connected to a suitable sensor or gyro.

A Class A sends data at the following rates as in the table below:



VESSEL SPEED	CLASS A TRANSCEIVER
Ship at anchor or moored	3 minutes
Speed 0 - 4 knots	Every 10 seconds
Speed 0 - 14 knots and changing course	Every 3.3 seconds
Speed 0 - 23 knots	Every 6 seconds
Speed 14 - 23 knots and changing course	Every 2 seconds
Speed >23 knots	Every 2 seconds

### CLASS A AIS TRANSPONDER UPDATE RATE

#### Static Data:

This data is programmed into unit at time of installation. It includes MMSI number, call sign, vessel name, type of vessel and size. In addition, a Class A unit can also send the IMO identity of the vessel. This data is sent every 6 minutes for Class A and Class B systems.

#### Voyage Data:

Programmed into Class A units (not available on Class B) before and/or during each voyage: Destination, ETA, draught, and number on board. It is transmitted with static data every 6 minutes.

### HOW DOES AIS WORK?

AIS uses a technique called Time Division Multiple Access (TDMA) that allows multiple transmitters to grab available time slots during which they can transmit their information. This technology is widely used in GSM cellular communications but unlike cellular, there is no base station as a ship has to be autonomous on the ocean. Two VHF frequencies are allocated to AIS – 161.975MHz and 162.025MHz. Each transmission is very short at just 26.5ms. This allows for up to 4500 transmission slots every minute. However, to ensure slots are correctly allocated and there are no collisions of transmissions, additional protocols called SOTDMA and CSTDMA are implemented depending upon the type of AIS device:

#### SOTDMA (Self Organised Time Division Multiple Access)

Before an AIS transmitter is able to transmit, it first listens to the AIS frequencies to build a time slot map that indicates the slot locations of other nearby AIS transmitters. With this information, an AIS transmitter knows that when it does transmit, it won't interfere with another AIS. Furthermore, the AIS device has to announce ahead of time which time slots it will use, and it can't use the slots that have been reserved by another device. As it listens, the AIS knows where other devices are and which slots they're reserving next. This effectively guarantees the AIS a transmission slot and in the event of more than 4500 slots being taken, the closest transmissions will be prioritised. Class A AIS transceivers use SOTDMA techniques.

#### CSTDMA (Carrier Sense Time Division Multiple Access)

As the name implies, "Carrier Sense" devices sense if a time slot is empty and quickly grab it. This means signal collisions can occur and Class B transmissions are not guaranteed although in practice this is extremely rare. Most Class B transceivers use CSTDMA techniques although a new standard has been introduced called Class B SO.

#### AtoNs - FATMDA (Fixed Access Time Division Multiple Access)

AtoNs use a different protocol again. A Type 1 AIS AtoN is a transmit only device using the FATDMA access scheme. This requires that the AIS AtoN is configured with fixed AIS time slots in which it will transmit AIS messages. Mobile AIS stations operating in the area where a Type 1 AIS AtoN is installed need to be aware of



the time slots allocated to the AIS AtoN. The slots allocated to the AIS AtoN are 'reserved' by AIS Base Station transmissions covering the area in which the AIS AtoN is installed. This mode of operation therefore requires that an AIS base station is operating in the same area as the AIS AtoN and is configured to make the necessary slot reservations.

#### AtoNs - RATDMA (Random Access Time Division Multiple Access)

A Type 3 AIS AtoN has transmit and receive capability and can therefore use either the FATDMA or RATDMA access schemes. The RATDMA scheme allows the AIS AtoN to internally allocate slots for transmission of AIS messages without reservation from an AIS Base Station. AIS receive capability also allows a Type 3 AIS AtoN to be configured and queried for status via AIS messages sent from a shore station (known as VDL configuration). An extension of VDL configuration is 'Chaining' where configuration and query commands are passed along a 'chain' of AIS AtoN stations to a distant station beyond the range of direct communication with a shore station. RATDMA is used by Class A AIS stations for 'network entry'. This occurs when a Class A device is first switched on and has not previously announced its own slot allocation using SOTDMA. An initial RATDMA transmission is used to solve this problem.

### INSTALLATION OF AIS

A Class A transceiver will include an internal GPS receiver and the devices will normally be delivered with a suitable external antenna. It also requires connection to a dedicated VHF antenna with minimum 3dBi gain. While its display (known as the MKD) can show targets graphically and numerically, most installations will interface the Class A AIS with the ship's ECDIS or chart plotting system. This will provide a much better representation of AIS targets on a larger screen with charting and/or radar as a layer. The Class A should also be interfaced with a heading sensor or gyro for heading and rate of turn information if this is available. This is a mandated requirement for ships on international voyages.

A Class B AIS will always utilise its embedded GPS receiver and cannot utilise an external positioning device. It also requires a dedicated VHF antenna but many users of Class B devices opt for a specialist AIS-VHF antenna splitter which allows the main VHF antenna to be shared between VHF and AIS. The technology within a splitter is complex and not a simple passive splitter arrangement. For this reason, a splitter adds cost but minimises antenna clutter and may be a great solution for a sailboat. A Class B device has no dedicated display so must be interfaced with a chart plotter.



### INTERFACING AND AIS NMEA DATA FORMATS

The maritime industry uses an interface standard called NMEA to interconnect items of electronics.

There are two NMEA0183 sentences reserved for AIS:

- !AIVDM (other vessels)
- !AIVDO (own vessel)

The VDO message was intended to provide own ship data to a listening plotter or ECDIS but in reality, very few systems read and use this message.

The VDM sentence is transmitted each time an AIS message is received. The AIS sentences use 6 bit binary encoding for the bulk of the sentence to reduce the amount of data, where inside the encoding will be one of 27 AIS messages

In addition to NMEA0183 HS interfacing, many Class B devices incorporate a NMEA2000 interface. This is the latest standard from the NMEA for on board equipment interfacing and it uses a canbus format for bigger and more reliable networks. This protocol has been embraced fully by the leisure industry with a simple plug 'n play format using standard connectors and therefore most Class B AIS products interfaced today on recreational vessels will utilise this standard.

### PRESENTATION OF AIS DATA

AIS targets are traditionally shown as small isosceles triangles pointing in the direction of their heading, making it easy to see what targets may be on a collision course. Clicking on a target will bring up additional information such as static data like boat name and call sign as well as dynamic data such as course and speed of the target. Most devices will also calculate important anti-collision information such as closest point of approach and time to closest point of approach. Alarm parameters can then be setup to warn the navigator of any dangerous targets. As AIS has become more ubiquitous, chart plotter manufacturers have improved their AIS user interface and many now colour code the targets depending upon vessel type and provide extensive filtering and alarming functions. It's important to remember that these functions are related to the plotter chosen.

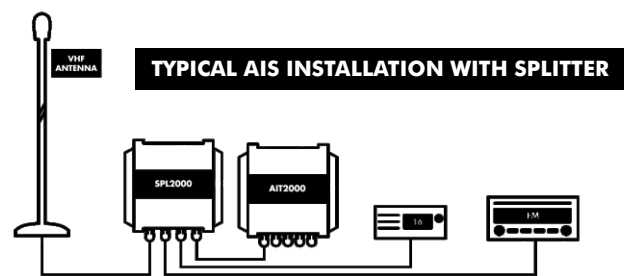



## AISNET +

Many ports and maritime offices want the benefit of a local AIS feed to see shipping activity, ETAs and movements. Digital Yacht's AISNet+ AIS base station is a low cost AIS receiver designed for just this application with a network port for connecting to local computer networks or to the internet for relaying of local signals to services like Marine Traffic and other internet based AIS monitoring solutions. It also has a USB connection for a simple plug 'n play connection to a local computer and ships with viewing software for Windows. The system also integrates well with popular coastal surveillance software such as MaxSea/Time Zero and will overlay AIS information onto their charting and radar overlays.



**AISNET +**

## AISNODE

AISnode is the first AIS Receiver to be designed exclusively for NMEA2000. With a single, integral 0.75m NMEA2000 cable that takes power from the network and outputs the AIS data on to the network, the AISnode is incredibly easy to install. Just find or fit a spare NMEA2000 "T Piece", screw the AISnode cable to the connection, connect a VHF antenna and the installation is complete.

Utilising the same high performance, true dual channel receiver that our latest Class B Transponders have, AISnode will receive every AIS equipped vessel within VHF range and never miss or drop a single target. All of the latest NMEA2000 AIS message types are supported, including AIS SARTs, AtoNs and Class B static data, ensuring full compatibility with all of the latest AIS enabled chart plotters.

Simply connect the AISnode to a dedicated VHF/AIS antenna mounted on the stern rail or connect it to the main VHF antenna via a suitable splitter and the AISnode will receive all AIS targets within range – typically up to 30nm (antenna/installation permitting).

## AIS100 PRO

Great entry-level AIS receiver for use with PC navigation software and chart plotters, such as the latest Garmin, Raymarine, Navico, Standard Horizon and Furuno units. Connected to an existing VHF antenna (via a splitter) or dedicated AIS antenna, you can receive all AIS targets within range – typically up to 30nm. Simple plug and play USB connection to a PC. Uses standard drivers built-in to Windows XP/Vista/7 and is automatically mapped to an available "virtual" com port, which your PC software can read. Also compatible with Mac OS X and all LINUX Kernels since V2.4.20.

The AIS100 Pro has a dual NMEA0183 and USB output capability, allowing you to supply AIS data to a PC (via USB) and a dedicated plotter (via NMEA) for larger installations. Connect the NMEA (4800 baud) output of your GPS to the AIS100Pro and it will automatically multiplex (merge) the slower GPS data with the high speed AIS data and transmit everything on the high speed NMEA output (38,400 baud) – perfect for connection to a chart plotter with only one NMEA input.



**AISNODE**

**AIS100 PRO**





## AIT1500N2K

The AIT1500N2K is a Class B AIS transponder with built in GPS antenna to make installation as easy as possible. The super sensitive design allows below deck mounting on GRP boats such as small yachts, RIBs and center consoles and cuts down on antenna clutter. It connects to your boat's electronics via a plug 'n play NMEA2000 connection and power is also taken from the NMEA2000 backbone. Simply connect a VHF antenna (or use our SPL1500 AIS-VHF antenna splitter) and you're equipped with Class B AIS transponder.

Once installed, your AIS compatible plotter will show an overlay of targets and you'll transmit your position every 30 seconds when underway to other AIS users. There's also a USB interface for PC/MAC connectivity which can be used for programming the transponder with your boat details.



**AIT2500 TRANSPONDER**



**AIT1500N2K TRANSPONDER**

## AIT2500

The AIT2500 is a full function SOTDMA AIS transponder with NMEA0183, NMEA2000 and USB data outputs. It is supplied with a GPS antenna and requires connection to a VHF antenna or suitable VHF-AIS antenna splitter.

The AIT2500 has the option of an AIS SART alarm which is great for use with personal AIS MOB devices.

## AIT3000

The new AIT3000 "Nucleus" Class B AIS incorporates not only a full function Class B transponder but also an antenna splitter allowing the main VHF antenna on the boat to be shared with the AIS and VHF.

It's also been designed with the latest interfacing capability including NMEA0183, NMEA2000, USB and a WiFi server to allow tablets and iPads to connect, becoming the hub for on board navigation. NMEA data from other onboard systems can be multiplexed by the Nucleus and combined on the WiFi link.

Other features include a silence switch option allowing the unit's transmissions to be stopped while continuing to receive AIS transmissions. It also has an output for a FM stereo radio and works with the popular Navionics Boating App for Apple iOS and Android to display GPS and AIS data on your Navionics charts.

## AIT5000

The AIT5000 incorporates a patented ZeroLoss VHF-AIS antenna splitter allowing the main VHF antenna to be shared with VHF, AIS and FM radio. It also has a wireless interface for connecting to iPads, smartphones and tablets.

The AIS transmissions can be stopped with our AISConfig app and with a remote silence switch. It also has the option of an AIS SART alarm which is great for use with personal AIS MOB devices. This model also works with the popular Navionics Boating App.

## AIT2000

The AIT2000 is an AIS transponder class B. It uses the latest AIS Transponder technology to squeeze more performance and interfacing options in to a housing that is half the size of our previous generation transponder.

This ultra-compact Class B Transponder has three outputs; NMEA0183, NMEA2000 and USB connection, allowing it to work with every AIS compatible chart plotter or software package on the market today. Featuring a remote silence button option, two NMEA0183 Inputs and Outputs, four status LEDs and rugged vibration-proof mounting brackets.

For permanent USB connection to a PC or MAC, we recommend adding one of our NMEA to USB Adaptor cables, which provides an extra level of electrical isolation/protection against ground differences and static discharge.



**AIT5000 TRANSPONDER**



## NOMAD

Nomad is a new, portable AIS transponder from Digital Yacht. Designed for recreational boaters and professional mariners, it offers a full function, Class B AIS transponder with a wireless and USB interface built in for tablets and PCs – all in a portable, compact package.

It addresses the needs of so many boaters who want a portable yet sophisticated navigation solution with AIS and GPS and the ability to interface with tablets, PCs and smart phones. It appeals to charter skippers, professional mariners like delivery skippers and pilots as well as boat owners who don't want the hassle or cost of installing a dedicated transponder and like the concept of easy iPad and tablet navigation. As a full function Class B transponder, it also sends you boat position to other AIS users.



**NOMAD PORTABLE TRANSPONDER**



**CLA2000**

## CLA2000 CLASS A AIS TRANSPONDER

CLA2000 is the ultimate SOLAS and inland waterway globally approved Class A AIS transceiver. Water and weather proof to IP67, it has a full integrated 5" hi-res colour display supporting a wide range of functionality including electronic chart navigation with optional C-Map MAX charting and AIS target management.

Proven, superior real world AIS message receive and transmit and message processing performance is delivered by advanced core SDR AIS technology. This state of the art technology ensures you see more targets, more of the time and at maximum range.

The CLA2000 will find applications on SOLAS mandated vessels over 300GRT as well as workboats, rescue services, inland waterways users, RIBs, large yachts and any user wanting premium AIS performance and safety.

## IAISTX CLASS B AIS TRANSPONDER

iAISTX has been designed specifically for the growing number of boaters who use an iPad or Android tablet for their navigation tasks. As a full function Class B transponder, it sends your boat position and identity data to other AIS equipped vessels as well as providing a wireless interface for mobile devices with popular apps to display received data from other AIS equipped vessels.

iAISTX creates a secure, password protected, local Wi-Fi network which allows AIS and GPS data to be sent to popular iOS and Android apps such as Navionics, iSailor, Weather4D, SailGrib, iNavX, TimeZero and more. These apps offer a detailed overlay of local AIS targets all updated in real-time. Depending upon the app, you can click on a target and can see identity as well as collision avoidance data such as CPA (closest point of approach) and TCPA (time to closest point of approach).

AIS transponders require one time programming with the boat's identity and physical dimensions through a simple, embedded web interface via the tablet's browser. This can also be used to silence the transmission and set up wireless parameters such as passwords.



**IAISTX**

**the iAISTX Plus includes an additional NMEA2000 interface.**



## GV30 ANTENNA AIS VHF GPS ANTENNA

A Class B AIS transponder requires a dedicated GPS antenna as well as a VHF antenna or suitable VHF-AIS antenna splitter. The GV30 is a combination of VHF and GPS antenna with twin coax feeds (10m). Please note antenna mounting base is not included.

Despite its compact dimensions, it offers very good performance as its specifically tuned to 162MHz (AIS frequency).

## KS30 VHF ANTENNA

A 1m tuned AIS VHF antenna supplied with 5m cable (RG58) and BNC connector to fit all Digital Yacht AIS receivers and transponders.

The VHF antenna KS30 provides excellent performance as tuned to 162MHz.

## HA156 VHF HELIFLEX ANTENNA

A 15cm VHF heliflex antenna, this is specifically tuned to AIS (162MHz) frequencies for optimal performance and it will perform as well as much larger. It's lightweight and has low windage and is supplied with a L bracket for easy installation onto any vertical surface.

It includes 20m cable with BNC connector for any AIS products such as our Class B AIS Transponders or AIS receivers.

## QMAX

This compact 25cm VHF antenna with sucker cup style mounting is designed specifically for use with our Nomad portable AIS system but can also be used as an emergency VHF antenna if used with a suitable BNC to PL259 adaptor (not supplied).

This base loaded 1/4 wave antenna, comes complete with an integral 4m (12ft) cable, fitted with a BNC connector and rubber suction cup for fast, easy mounting to any smooth horizontal surface.

## CX4A COMMERCIAL VHF ANTENNA

Powerful AIS Tuned commercial VHF Antenna that will give you maximum AIS range. It has an SO239-Type female connector in the base of the Antenna and we recommend using this with low loss 50 ohm coax cable such as RG-213 for best performance (not supplied), particularly on long cables runs

A very high quality 3dB AIS tuned GRP antenna which is ideal for professional and super yacht installation.

## SPL1500/2000

An AIS receiver or transponder requires a VHF antenna or, Digital Yacht's new SPL1500 VHF antenna splitter allows an existing antenna to be used for both the AIS and VHF (DSC). Unlike most simple splitters, it can also be used with a class B AIS transponder system and it incorporates special circuitry to ensure safe operation of the two transmitting devices.

The unit has three simple connections – one input for the main VHF antenna and then outputs for the AIS receiver/transponder and another for the DSC VHF. A fourth connection is fitted to the SPL2000 model with an optional car radio output. It utilises Digital Yacht's new, patented, ZeroLoss™ technology, to ensure the very best possible reception and transmission from all devices. Most importantly it is also fail safe, so should the unit ever stop working or lose power, it will not affect the main VHF operation. Until now, Digital Yacht, have recommended a dedicated antenna for a receiver or transponder. However, with the new this new ZeroLoss™ technology, we can now offer a solution that greatly simplifies installation whilst maintaining performance.

The unit is waterproof and can easily be integrated into any vessel. It is suitable for operation on 12V or 24V systems and features three status LEDs that show the unit is powered correctly and when the AIS or VHF transmits.

### SPL2000 AIS-VHF ANTENNA SPLITTER

### SPL1500 AIS-VHF ANTENNA SPLITTER





# NAVIGATION

## TRINAV TECHNOLOGY



Digital Yacht offer a range of primary instrument sensors including position (GNSS), compass heading, wind and speed/depth. These all have industry standard NMEA outputs allowing connectivity with a wide variety of systems and products. Our iKconnect, WLN and STN Gateway products allow data exchange between other data formats too including NMEA 2000, USB, SeaTalk and WiFi for tablet connectivity.

The GPS160 TriNav offers unprecedented value for money and accuracy and takes advantage of compatibility with GPS, Glonass and the new Galileo satellite systems.



# TriNav

WindSense from Digital Yacht is a wireless wind system designed to allow iPads, tablets, SmartPhones and PCs to display accurate apparent wind speed and direction. A high quality, precision mast head sensor connects to a below decks interface unit creating a wireless and NMEA0183 wired connection. Existing NMEA compatible sensors can also be connected to the NMEA input to allow the wireless network to share other available on board instrument data. It's compatible with a wide range of apps for iOS and android.

Wind sense provides a low cost replacement or addition to any marine electronics system but offers significantly enhanced accuracy, reliability and functionality with easy interfacing enabling a tablet to become a complete instrument display with other connected sensors. There are many vessels equipped with just a speed and depth system who require wind data too and also many older wind systems requiring replacement where customers do not want the substantial cost of a totally new instrument package. Depending upon the app utilised, true wind information, VMG and other sailing performance parameters like polars may also be displayed.



## GPS160

A new high performance positioning sensor using GPS, Galileo and Glonass satellite systems for exceptional positioning accuracies and redundancies.

TriNav technology allows all three systems to be simultaneously utilised for navigation. The device can also be field programmed for a variety of modes such as single GNSS operation (eg Galileo only) as well as output configurations such as update rate, NMEA sentence structure etc.

The GPS160 is available with a NMEA0183 output (4800, 38400 and 115200 baud programmable) and a USB variant for PC, MAC and Linux. For NMEA 2000 systems, a bundle is available with iKonvert allowing easy and flexible NMEA2000 installation without the need for cumbersome drop cables.

The GPS160 also support an external MOB switch or device. When activated, it creates a "synthesised" AIS SART MOB message on the NMEA output which can be interfaced with a local plotter for MOB identification.

## GALILEO GNSS

The GPS160 supports GPS, Glonass and Galileo positioning. Our TriNav technology is used to combine signals from all three systems to compute the best possible fix accuracy and reliability. Galileo is the new global navigation satellite system (GNSS) that has been developed over the past two decades. It joins the GPS and GLONASS systems and offers mariners a 3rd reliable positioning source.

The EU funded €10 billion project is named after the Italian astronomer Galileo Galilei. One of the aims of Galileo is to provide an independent high-precision positioning system so European nations do not have to rely on the U.S. GPS or the Russian GLONASS systems which could be disabled or degraded by their operators at any time. The use of basic Galileo services will be free and open to everyone. Galileo is intended to provide horizontal and vertical position measurements within 1m precision and better positioning services at higher latitudes than other positioning systems. Galileo will also provide a new global search and rescue (SAR) function as part of the MEOSAR system enabling an acknowledgement signal for EPIRBs of a distress signal received.



**GPS160**

## TYPICAL GPS160 INSTALLATION

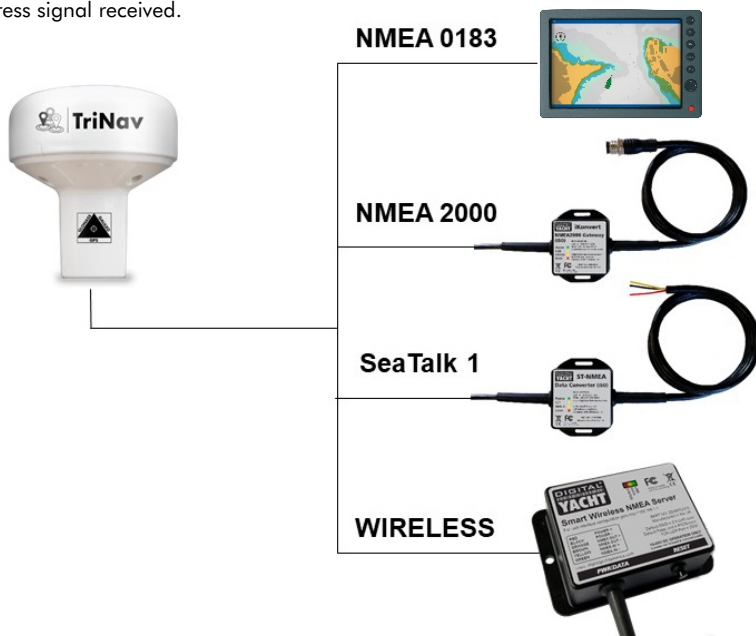
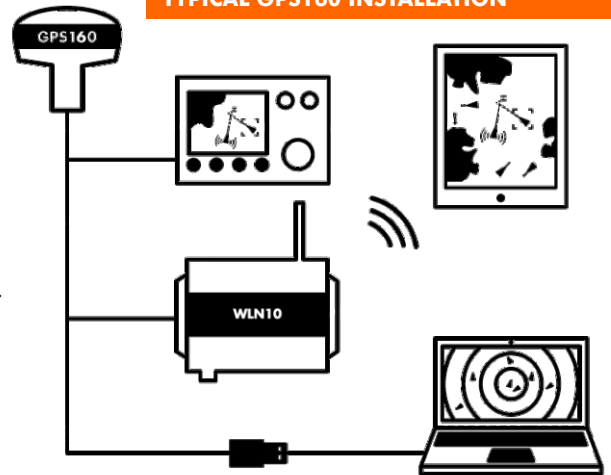

### NMEA 0183

The GPS160 has a standard NMEA0183 output for connection to plotters, instruments and systems.

### NMEA2000

For NMEA2000 systems utilise our iKonvert gateway which allows an easy and thin cable to be run from the GPS160 to the nearest point on the NMEA2000 backbone for the iKonvert to connect to. A bundle is available of both items.

### SEATALK1

For legacy SeaTalk 1 systems, we offer a bundle with the SeaTalk to NMEA adaptor allowing easy replacement of older Raystar sensors.

### WIRELESS

For wireless navigation with tables and iPads, use our VLN10SM NMEA to wifi gateway. A bundle is available of both items.

### USB

The GPS160USB variant ships with a 5m cable. It's self powered from the USB source (PC, MAC or Linux). When installed, a virtual COM port is created on the host PC so navigation programs can receive positioning data.



## WINDSENSE

The wireless wind sensor WindSense features an ultra tough Wind Transducer with Igildur™ bearings for exceptional life and corrosion resistance. Data transmission is via a super-thin 20m digital cable providing fast update NMEA0183 data to the below deck wireless interface.

Wind data is then wirelessly streamed to any compatible App or Navigation software package enabling Apparent, True, Close Haul or Running data to be displayed on an iOS, Android, Mac or Windows device. Up to 7 mobile devices can receive the same data, so crew and family members can also see exactly what the wind is doing.

The Wireless interface box has a configurable NMEA0183 input/output (4800/38400 baud) allowing GPS, Instrument or AIS data to be multiplexed (combined) with the WindSense data and streamed to the mobile devices/apps.



**WINDSENSE**  
Note: iPad not included



**HSC100 COMPASS**

## HSC100 COMPASS SENSOR

Accurate fluxgate compass heading data remains a fundamental parameter for marine navigation and the HSC100 uses fluxgate technology to deliver heading data for onboard systems. Typical applications include enabling course up and true motion type displays on chart plotters, radar overlay onto electronic charts and stabilisation of radars when used for MARPA/ARPA target tracking. Integrated instrument systems can also benefit from having compass information to calculate real time tidal set and drift when interfaced with a log and GPS.

Most low cost heading sensors only output data at 1Hz (once per second) but the HSC100 outputs at 10Hz which is required for MARPA target tracking and accurate radar overlays.

We have also released a new "Rate of Turn" version of the HSC100 that outputs the HDT and ROT messages required by a Class A transponder. For non-mandatory vessels, this provides a simple low cost solution for adding heading and rate of turn to Class A transponders.

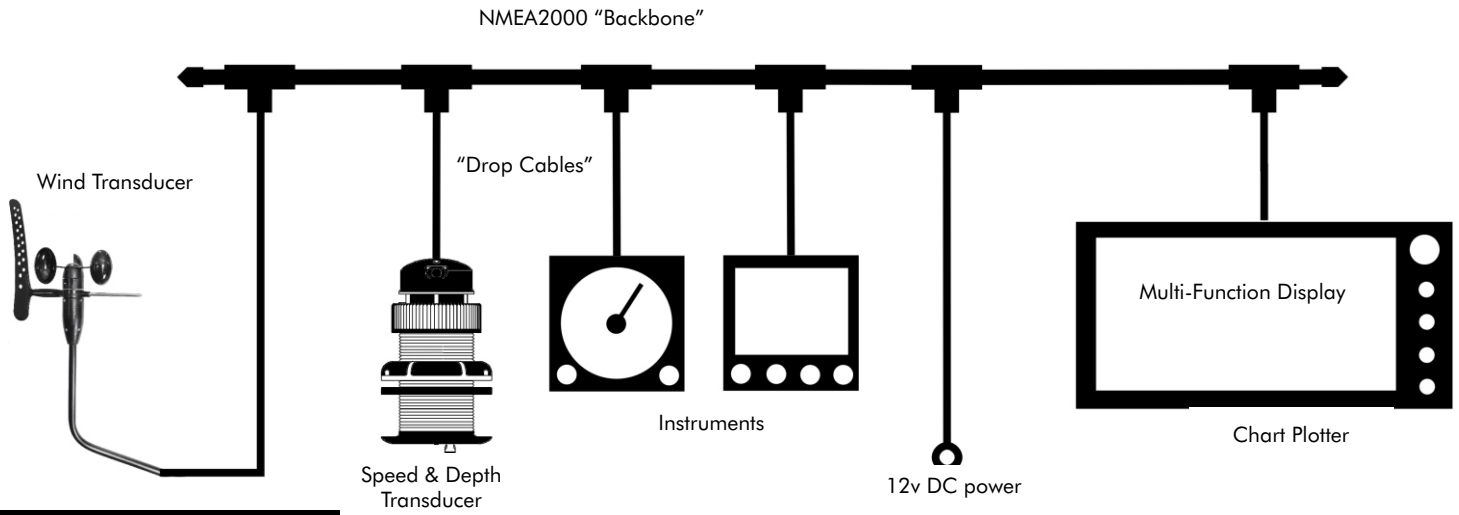

**TYPICAL NMEA2000 NETWORK**

## NMEA2000

NMEA2000 has now become the de-facto standard throughout the marine electronics industry for interconnection of devices. It uses a simple backbone (or sometimes called "trunk") structure with requires terminators at each end of the cabling and then each device can be spurred off using a drop cable. The bus also requires power. Waterproof connectors are used throughout for maximum reliability and it makes for an easy plug 'n play installation.

Nearly every new marine electronics product has an NMEA2000 interface now, but it is still "black magic" to many boat owners and even fairly technical users struggle to understand NMEA2000 and what is needed to make products work correctly together.

With our large range of AIS, often the first add-on device to make a boat owner think about NMEA2000, we are regularly asked "what do I need to make it work?" This prompted us to create a cost effective and smart NMEA2000 Starter Kit that is ideal for smaller boats but can also be easily expanded in the future.

There are other starter kits on the market, but none offer three device connection, metal connectors and a smart 4-Way T-Piece at such a good price.

By utilising the NMEA2000 standard "Micro C" type connectors, users can easily add and expand to this Starter Kit as their installation grows or simply buy two or more kits for a larger install, still cheaper than buying the parts separately. Typical Starter Kit install the three connections to connect together, small chart plotters, AIS and smart speed and depth transducer.





# iPAD & TABLET NAVIGATION

## Wireless integration

At Digital Yacht we define portable navigation as being able to use a laptop, tablet, smartphone for navigation and mapping. With the rise of technology, portable navigation is becoming more and more common. Navigation/mapping applications and software are more and more popular and numerous for Android or Apple products and now most of them support NMEA data allowing your tablet, smartphone, laptop to become a complete and trusted navigation system.



### BENEFITS OF IPAD & TABLET NAVIGATION

There are numerous benefits of using an iPad or tablet for navigation. Obviously, the financial aspect is the most important for portable navigation, where a simple system allows you to get all navigation data on your mobile devices. With most people already owning a tablet or smartphone, the user only needs to purchase the product needed to transmit the data to these devices.

Tablet navigation also gives the user the ability to greatly improve their electronic system and utilise a navigation system with unlimited functions. If a chart plotter is already owned, customers can connect their existing plotter system to a product that will broadcast NMEA data wirelessly. This works with all major brands including Raymarine, Navico, Furuno, Garmin, etc.

This means that if the customer already has a tablet or smartphone they will receive the data and be able to use comprehensive and powerful applications or navigation software.

For example, the customer will be able to broadcast AIS data on a tablet that they can use cooperatively with their plotter and therefore he will be able to navigate and track a route on the existing plotter and at the same time look at the surrounding AIS targets on the tablet.

Some customers also like this system because they can use it on various boats. Simply disassemble and then reassemble your Digital Yacht product on another boat to provide a very quick and easy solution.

In addition to navigation and cartography, having an iPad, Tablet or Smartphone on board allows you will be able to connect to the internet (if you have access) and therefore check your emails, surf the internet, Youtube, Facebook, etc.

Moreover, the portable navigation is a backup solution in case of problems with your main chart plotter. Also if your chart plotter has a small display, portable navigation can be a perfect solution for you. For a minimal cost, you will get all your data on a much larger screen.

Chart plotters are limited to navigation, whilst tablets can also display weather data and receive navigation data from the internet too.

### CAN WE TRUST PORTABLE NAVIGATION?

Nothing is more powerful and reliable than a chart plotter from a well established brand. However, portable navigation is becoming more and more reliable, If connected to good navigation sensors then you can assume that your navigation system without a plotter will be 99% reliable.

### WHAT DO YOU NEED TO GET STARTED WITH PORTABLE NAVIGATION?

- A tablet and/or a smartphone.
- A GPS antenna to connect to a system that will broadcast GPS data to your mobile devices via Wi-Fi technology. With this system, the tablets will receive GPS data from the antenna and will not need to use their internal GPS, which is not as powerful.
- An NMEA to Wi-Fi system such as the Digital Yacht WLN10 or Navlink 2. Wi-Fi is a the most efficient way to broadcast NMEA data.



## WLN10 SMART WIRELESS NMEA MULTIPLEXER

Digital Yacht's new WLN10 Smart NMEA to WiFi gateway takes iPad and tablet integration afloat even further with the ability to connect to existing on board GPS, AIS and instrument systems and transfer data wirelessly to an iPad or tablet – allowing compatible apps to display and compute with real time information. The WLN10 creates a secure, password protected wifi network on board to footprint the boat with data.



**WLN10**

When connected to, for example, an AIS system, real time AIS target positions and identity data will be displayed on detailed electronic charting through compatible apps including NavLink, TimeZero, iAIS, iSailor, Seapilot and hundreds more. The tablet becomes a full function navigation display.

This new version of the WLN10 can now be programmed through its simple browser interface for NMEA0183 data at 4800 or 38400 baud as well as allowing multiple devices to connect so you can be using a PC at the chart table with an iPad on deck. It's also bidirectional so apps can control an autopilot if this function is enabled.

## NAVLINK 2 WIRELESS NMEA2000 SERVER

NavLink 2 is an easy to fit NMEA2000 to WiFi server designed to make NMEA2000 navigation data available for apps on smartphones, tablets, iPads and PCs. It connects direct to the NMEA2000 back bone and is also self-powered from the data network so installation literally takes seconds.

Once installed, it creates a local WiFi network for devices to connect or can be programmed to join an existing wireless network if one is already installed. This is ideal for devices like the Furuno wireless radar which require operation through their own dedicated network but require NMEA2000 data integration for charting apps.

Now works with the popular Navionics Boating App for Apple iOS and Android to display GPS and AIS data on your Navionics charts.

## iKOMMUNICATE

Digital Yacht's iKommunicate provides the next generation of onboard interfacing where it creates an open source gateway for boats taking the "closed" industry standard NMEA2000 and NMEA0183 data and converts it into a new "open" HTML5 based internet ready data format for marine data called Signal K format. Once connected via iKommunicates Ethernet (RJ45) connection you are able to connect to the boats wired/wireless network such as a WiFi router and start sharing data with devices such as iPads, tablets and phones where they will display Signal K data within its browser or the 1000s of compatible apps.



**NAVLINK 2**



Enabling the internet of things afloat



VISIT [WWW.DIGITALYACHT.NET](http://WWW.DIGITALYACHT.NET) FOR OUR GUIDE TO THE "BEST MARINE APPS FOR IOS AND ANDROID"

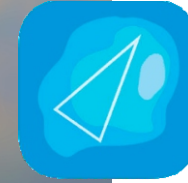
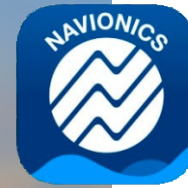
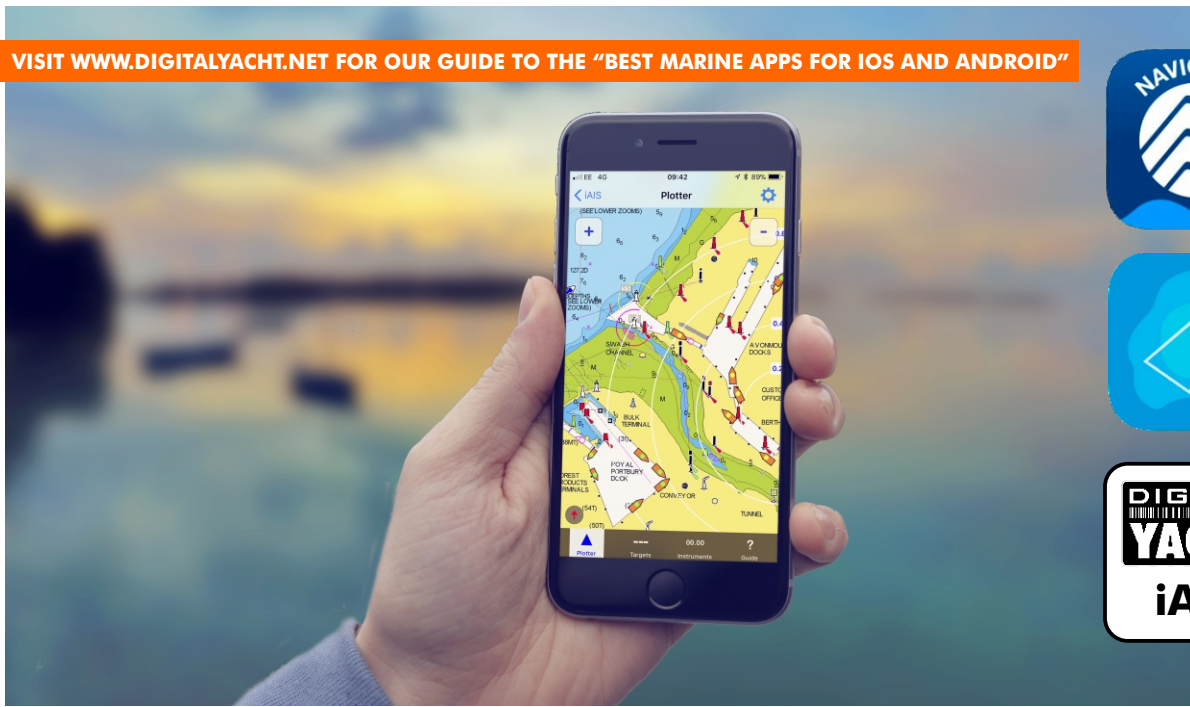

### iAIS APPLICATION

iAIS is a simple free AIS app for iPhone and iPad. It is a target plotter designed for use with Digital Yacht's iAIS WiFi receiver or any of our other Wireless NMEA products, if they are connected to an AIS system. iAIS is a fun and interesting App for anyone onboard a boat fitted with one of our Wireless AIS systems, allowing other vessels to be seen, tracked and identified.

A new version of Digital Yacht's iAIS app is now available that supports a background layer of charting utilising the popular and detailed Navionics charts. What's more, there's no requirement to re-purchase charts as long as you have a current Navionics subscription and app on the iOS device. The Navionics charting layer can be enabled with a low cost in app purchase.

AIS targets are plotted relative to iPhone/iPod/iPad position. Tapping on an AIS target displays details (i.e. speed, course, destination, type, length, etc.).

iAIS is also useful for testing a wireless NMEA system as it can show the raw wireless NMEA data (either TCP or UDP data packets) that is being transmitted by the wireless server.

### NAVLINK IOS APPLICATION

NavLink is a low cost app designed for use with an iPhone or iPad. It transforms your iPad into a full function chart plotter with detailed electronic charts and an overlay of your boat's position, track and heading.

It's purchased through the Apple app store and includes detailed Admiralty UKHO charts covering the whole of the UK & Eire. Additional USA (S57 NOAA), French, Benelux, German and Danish charts can be added via an In-App Purchase. The NOAA S57 charts cover the whole of the US.





# MARINE PCs

## WHY A PC ON BOARD?

Utilising a PC on board brings important benefits not just for regular PC tasks such as email and web access but also for entertainment and navigation. The number one, compelling reason to add a PC to your boat's navigation and communication system is amazing value. There's no doubt that a dedicated chart plotter is ideal for use at the helm where it needs to be waterproof and compact. But below decks, a PC can offer big screen performance at a very attractive price compared to a dedicated large screen multi-function display. Of course, a PC and chart plotting software can also be your only electronic navigation device, just integrated to the GPS and instruments via a simple NMEA interface.

A PC also offers more powerful functionality than a dedicated multi-function display with the ability to install software for lots of applications from navigation to entertainment, email communications, weather and internet connectivity. PCs are also up-dateable as new applications become available.

## WHY NOT A LAPTOP?

They are simply not designed for the hostile marine environment with constant vibrations and momentum from the boat and of course they're not designed for salty air. Laptops also consume large amounts of power and often you will need an inverter or adaptor to connect to the boat's DC supply which introduces more losses and electrical noise. It's a much neater solution to have a dedicated PC and display both in terms of functionality and reliability. With some simple engineering, you can install a monitor to swivel between chart table and saloon so it can become an entertainment as well as a navigation device.

The Aqua range of PCs from Digital Yacht are designed to be permanently installed and can connect direct to the boats DC electrical system. They consume minimal power and are completely solid state with no moving parts. Despite their impressive performance they are as affordable as a good quality laptop and can support multiple monitors.

## TYPICAL AQUA PC INSTALLATION

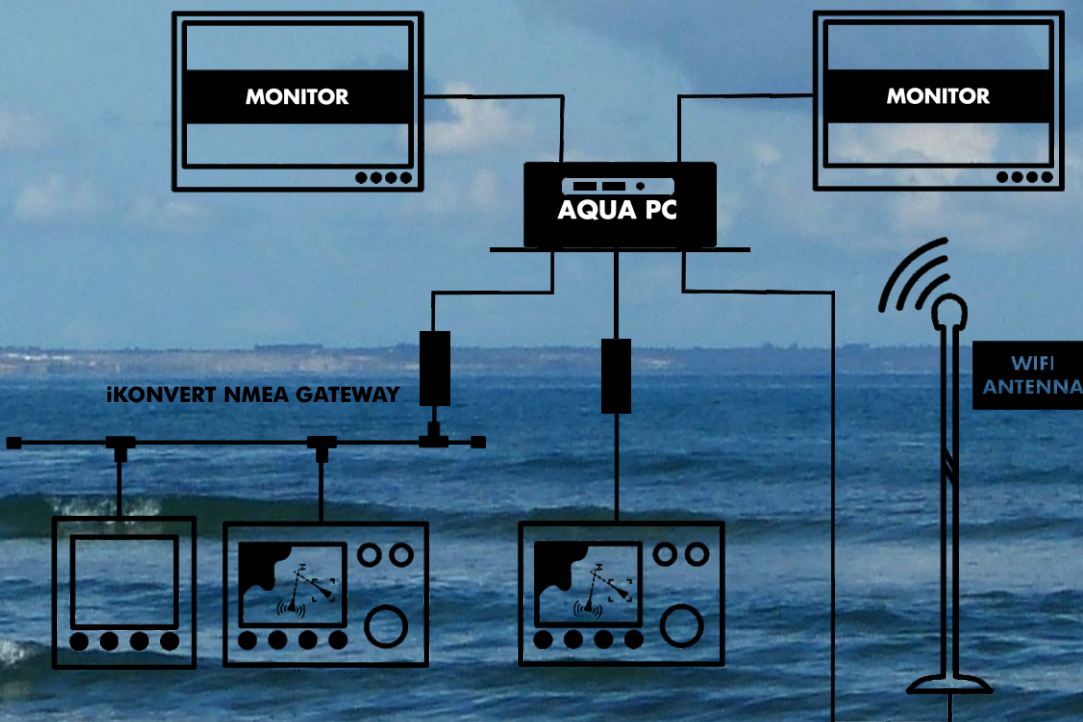





**AQUA COMPACT PRO PLUS**

## AQUA COMPACT PRO/PRO+ MARINE PC

Space is always at a premium on board and despite its slim line 11.5 x 11 x 5 cm dimensions, the Aqua PC packs in a powerful 8th generation Intel Core i3 processor with exceptional graphics performance for the latest 3D charting and HD navigation programs. It's the perfect partner for applications like Maxsea TimeZero – even with radar and 3D overlays.

The Aqua Compact Pro utilises a 8th generation Intel Core i3 processor with exceptionally fast HD 520 graphics for modern 3D charting and radar overlay applications. It's fitted with 8GB ram and has plenty of connectivity with built in WiFi bluetooth and SD Card reader plus 4 x USB 3 sockets. The Aqua Compact Pro + model utilises all the original features of the Aqua Compact Pro model but is fitted with an 8th generation Intel Core i7 processor.

## SMARTERTRACK PC NAVIGATION SOFTWARE

SmarterTrack is the ideal PC marine navigation software for anyone who has a dedicated chart plotter that uses Navionics Gold, Platinum or Platinum+ chart cartridges or who is new to electronic charting and wants simple to use PC navigation software with good AIS support.

Planning at home, monitoring from the chart table or as a self contained independent backup system, SmarterTrack turns your PC in to an invaluable independent backup system and navigation tool, that will display your GPS position and the location of all the surrounding AIS targets on the accurate and detailed Navionics electronic charts.

AIS support includes; colour coded targets, user selectable labelling of targets, fully configurable CPA and TCPA alarms, visual indication of CPA, AIS targets drawn to scale and many other settings and features that make this software ideal for displaying AIS data.

Entering the route you wish to sail, checking the tides, overlaying weather (GRIB files), confirming depths or nav-aids on the chart and a whole host of other routine navigational tasks can be performed simply and effortlessly with SmarterTrack. Supplied with a Navionics USB card reader that allows all Navionics cartridges used with Raymarine C/E series, Lowrance and Humminbird plotters to be used with SmarterTrack. Smartertrack can be used on any PC running a Windows XP/Vista/7/8/10 operating system. A fully NMEA 2000 compliant version is available with an iKonvert USB to NMEA2000 interface.

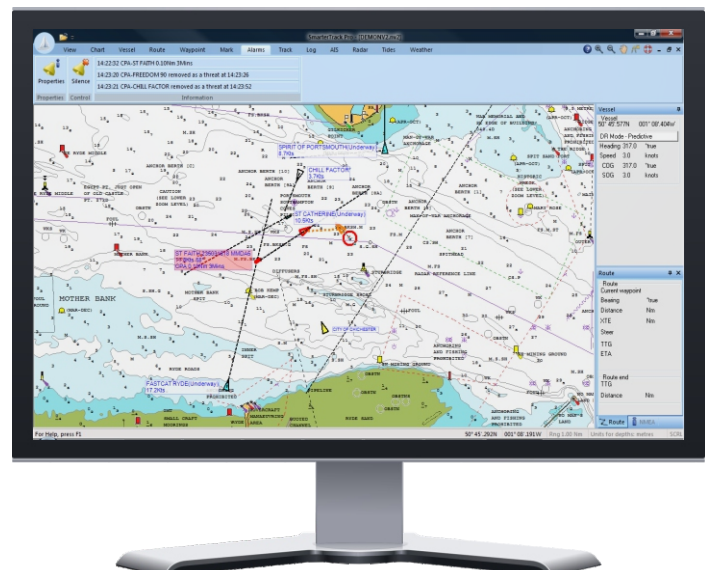



# ONBOARD NETWORKING



Digital Yacht NMEA Interfacing products provide smart and cost effective solutions for connecting dedicated marine electronics to the latest consumer devices such as smart phones, laptops and tablets. Both traditional wired and the latest wireless interfaces are available allowing you to easily transfer NMEA data to your mobile device. Whether you are an iPhone/iPad, Android, PC or Mac user, wireless (or wired) interfacing can now be simply added to your existing navigation system with the addition of one of Digital Yacht's smart little devices.

We've also created NMEA gateways to multiplex the NMEA data or to connect and convert the NMEA data to an ethernet network, USB or even the new innovative standard called Signal K.

NMEA is the National Marine Electronics Association (NMEA) and is a US-based marine electronics trade organisation setting standards of communication between marine electronics. There are currently two main standards: NMEA0183 and NMEA2000.

## NMEA0183

NMEA0183 is the most frequent standard on board and almost every marine electronic system has an NMEA0183 input and output. However, there is also different NMEA speeds which you may need to know:

- 4800 baud is the lowest NMEA speed and is the most used especially by chart plotter, GPS antenna, marine instruments, etc
- 38400 baud is mainly used by AIS systems such as AIS transponder, AIS receiver, etc.
- 115200 baud is the highest NMEA speed and is mostly used by racing boat to obtain a quick update of navigation data.

Knowing the different NMEA speeds is important when connecting and linking different marine electronics products. Although most of the new marine electronics products use the new NMEA2000 standard, they almost always keep an NMEA0183 connectivity.

## NMEA2000

This new standard came about due to the increasing number of marine electronics on board and thus more instruments to communicate between each other. It is a very easy plug-and-play communications standard. Most of marine electronics directly take their power from the NMEA2000 network. The main goal of NMEA2000 is to increase the communication speed between marine electronics products and also to facilitate their installation.

## SIGNAL K

Things are changing in the world of marine electronic interfacing with the introduction of a new open source platform called Signal K. It's been developing quietly over the past few years by a group of enthusiastic and very bright developers and boaters and is now ready for wide scale implementation. The name comes from the original Signal K (kilo) flag which indicates "I want to communicate"!

Signal K aims to be the next generation solution for marine data exchange. It is intended to be used not only for communication between instruments and sensors on board a single vessel, but also to allow for sharing of data between multiple boats, aids to navigation, ports, marinas, etc. It is designed to be easily implemented by web and mobile applications and to connect boats and ships to the Internet of Things Afloat.





## SEATALK TO NMEA DATA CONVERTER

The SeaTalk™ interface, originally developed by Autohelm in the early 1990's, was included on pretty much all Autohelm and Raymarine (and some Raytheon) products up until about 2012. As a result there are thousands and thousands of boats around the world that have a SeaTalk 1 network and many owners would like to get the SeaTalk data on to a PC, MAC or LINUX device.

Raymarine's own SeaTalk to NMEA converter (E85001) is no longer available, and although some instruments/MFDs/autopilots have NMEA0183 interfaces, they do not always convert all of the data, require additional NMEA to USB adaptors or are in difficult to wire locations.

Digital Yacht's SeaTalk to NMEA Converter is a small but powerful interface that provides bi-directional conversion between a SeaTalk network and a computer's USB interface (USB model) or a SeaTalk network and an NMEA0183 network or device (ISO model). Taking its power from the SeaTalk network, the ST-NMEA Converter features a full, multi-transistor SeaTalk 1 interface. The USB model features a high speed USB 2.0 interface that allows key navigational data to be reliably shared between the SeaTalk network and applications running on the computer. The ISO model features an opto-isolated NMEA0183 input and differential NMEA0183 output that allows key navigational data to be reliably shared between the SeaTalk and NMEA0183 networks.

For developers and advanced users that want to access the raw SeaTalk data, the ST-NMEA converter can also be configured to work in a special "Raw Data" mode (\$STALK) which is gaining support in some Open Source projects.

The Seataalk to NMEA converter (USB) is ideal for connection to any USB equipped computer (Windows/Mac/LINUX compatible), whilst the ISO version of the ST-NMEA is available for direct connection to NMEA0183 systems, allowing SeaTalk owners to go wireless.

## NMEA2000 STARTER KIT

The simple, low cost NMEA2000 starter kit allows for up to 3 devices to interconnect – say AIS, plotter and autopilot and comes complete with terminators and a power cable. It uses the high quality, nickel plated metal style connectors rather than the cheaper plastic type which can prove unreliable.

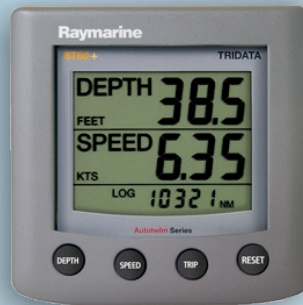
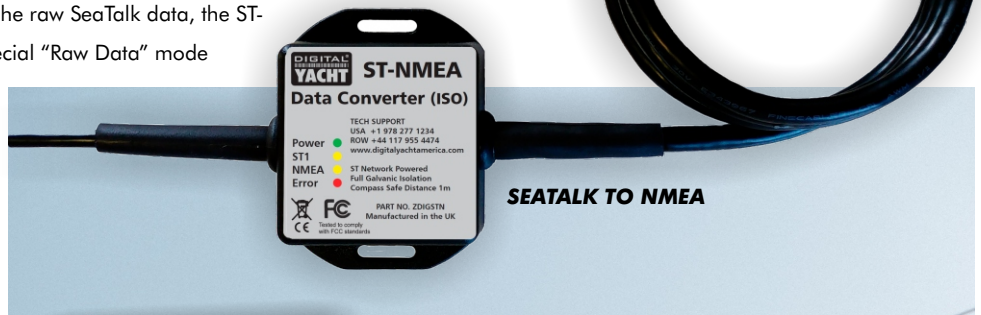
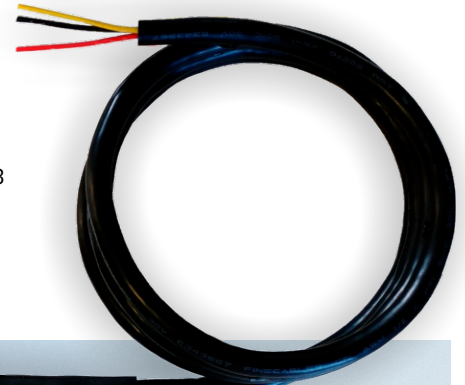

RAYMARINE ST60 DEPTH/SPEED TRANSDUCER



NMEA2000 STARTER KIT

The backbone of the NMEA2000 starter kit is formed from a unique 6 way extension block with ports at each end that accommodate the terminators. This allows for a really neat and compact installation – ideal for behind the helm. It's suitable for DIY installers as well as boat builders who want an easy and value priced solution for integrating and installing modern boat electronics.

The connection system will work with all leading brands and can be expanded using standard components as required.

## iKOMMUNICATE

iKommunicate is an intelligent NMEA gateway device that allows traditional boat navigation systems to be part of the "Internet of Things". By converting data from the "closed" industry standard NMEA networks found on most boats to Signal K the new "open" HTML5 based internet ready data format, a whole new world of social and connected boating will now be possible.

Traditionally marine electronic systems talked to each other via the industry standard NMEA0183 and newer NMEA2000 networks. Their interfaces are very reliable, well proven and fit for purpose, but the costs for developers to become NMEA members, buy the specifications and have their software certified has severely restricted the number of marine applications that have used NMEA data. With the release of Signal K, a new open data format for boats, all of this is about to change and it will suddenly become very easy for developers to read and use the NMEA data. iKommunicate is driving this change, as the first NMEA to Signal K gateway product that will connect to the NMEA networks and convert all of the data in to the new Signal K format.

Featuring three opto-isolated NMEA0183 Inputs, two differential NMEA0183 Outputs and an NMEA2000 Network interface, iKommunicate can handle whatever NMEA data is thrown at it.

## iKOMMUNICATE



Its 120MHz Atmel processor, efficiently converts the NMEA data in to Signal K JSON data, the standard for the latest generation of HTML5 websites and apps, which is then output via HTTP or multiple high speed Web Sockets.

iKommunicate's Ethernet (RJ45) connection, allows it to be connected to the boats wired/wireless network so that any mobile device connected to the network can display the Signal K data in its browser or compatible app. Pre-installed in iKommunicate are a couple of web apps (including the popular Instrument Panel) so that you can immediately start displaying NMEA data from your network.

## iKONVERT USB

The iKonvert NMEA2000-0183 Gateway/Converter USB model allows software applications to read/write NMEA2000 data, either as RAW binary PGN data for ultimate analysis and control or converted to the older and more commonly supported NMEA0183 data.

Every popular Marine Navigation application that runs on PC/MAC/LINUX computers, can read NMEA0183 data and for all of those programs, iKonvert provides a simple, reliable and cost effective way to access the navigation data on an NMEA2000 network. Simply set the DIP switches inside iKonvert to the required data mode that you want to use and iKonvert will extract the selected data from the NMEA2000 network and provide them to your marine application in a format and at a baud rate they support.

For developers creating new applications or who know how to decode NMEA2000 PGNs, iKonvert can be easily set to its "RAW Mode" where data can be read/written to using a simple serial data format that we publish on our iKonvert Github site. No special libraries or proprietary code are required to integrate iKonvert, which has attracted the interest of a number of developers and it is already compatible with CanBoat and the popular Signal K Node Server.

iKonvert's USB interface features an FTDI chip that has the most reliable and compatible USB drivers for all of the popular operating systems (Windows/Mac/LINUX/Android).

## iKONVERT NMEA2000 GATEWAY (ISO)

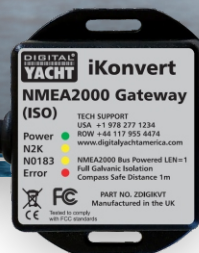

## iKONVERT ISO

The iKonvert NMEA2000-0183 Gateway/Converter allows new NMEA2000 equipment to talk to legacy NMEA0183 equipment. Conversions are bi-directional, so whether you want to get the data from older NMEA0183 sensors on to your NMEA2000 network or you have added a new NMEA2000 only MFD and want it to send GPS and Navigation data to your older NMEA0183 VHF and Autopilot, iKonvert will accurately and intelligently carry out the required data conversions.

There are many, many real life applications for NMEA2000 to NMEA0183, with a plethora of different makes and models of equipment that may need to be connected together. We have designed iKonvert to satisfy as many of these situations as possible by incorporating a simple but effective mode selection method, via a set of DIP switches inside iKonvert.

A number of modes have already been defined including; Heading, Sounder, AIS, GPS, Wind, Instruments and an all data gateway mode, which automatically sets the conversions to be done and the baud rate iKonvert will use.

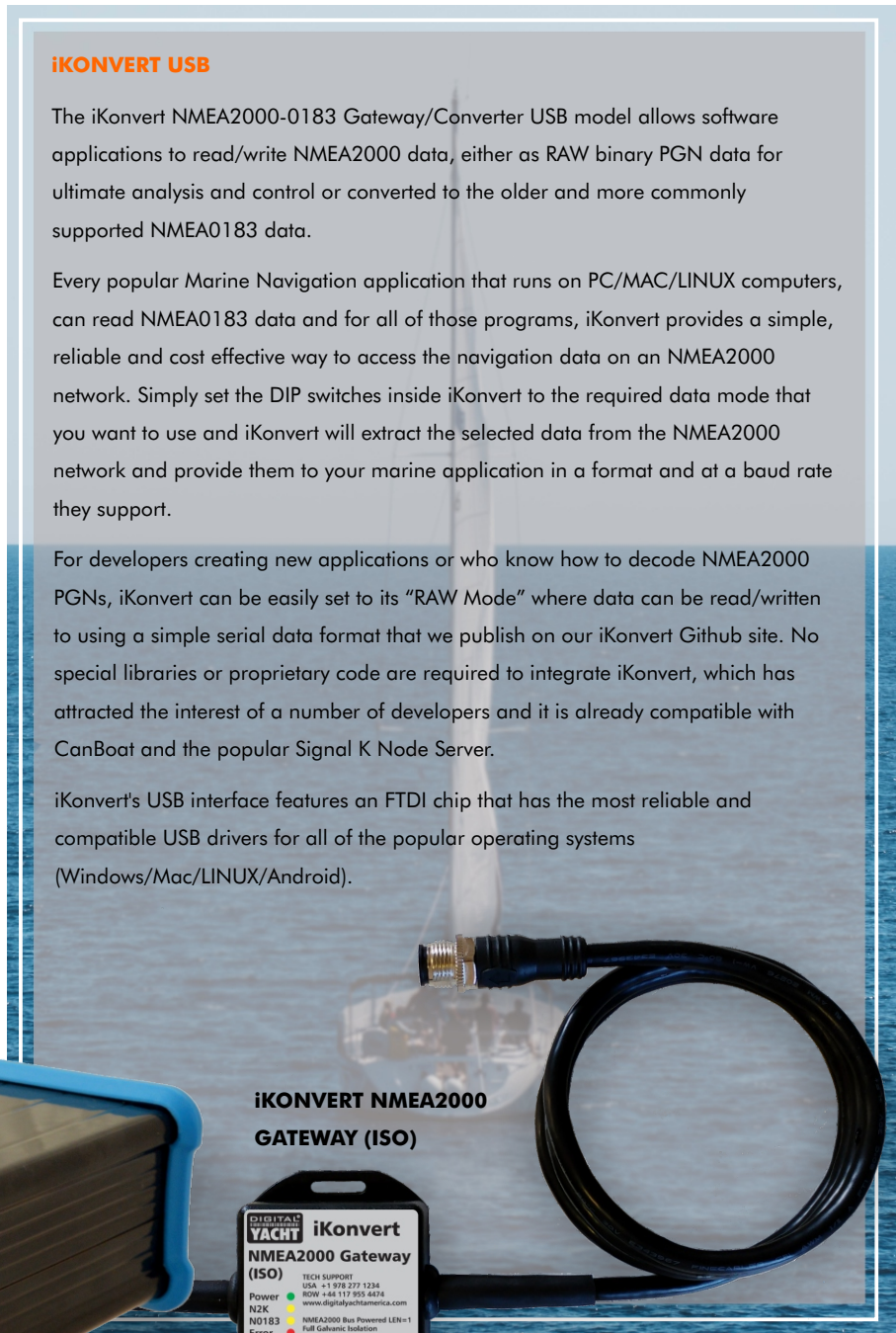





# INTERNET CONNECTIVITY

**TYPICAL 4G CONNECT AND WL510 INSTALLATION**

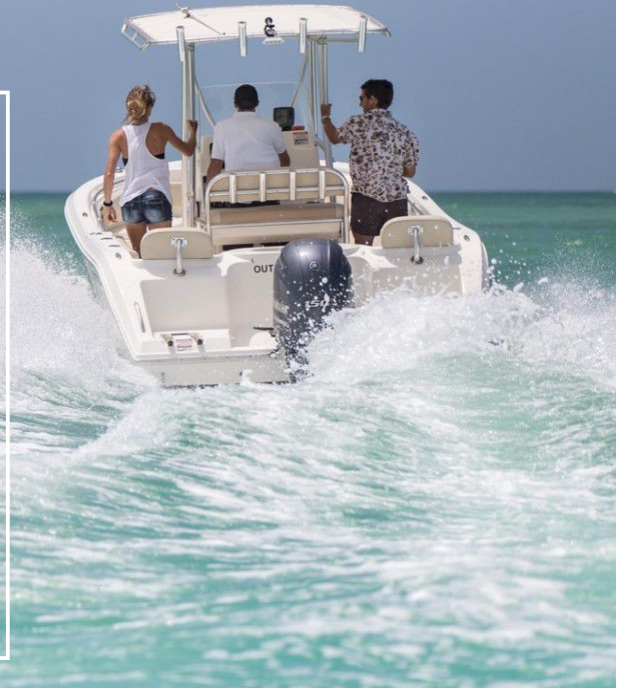
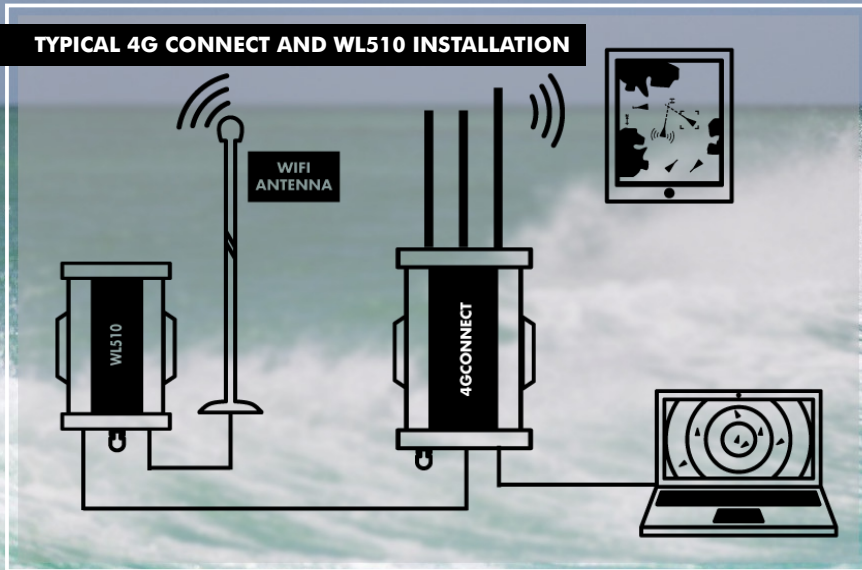

More and more boaters want access to internet afloat. Marinas and ports as well as a large number of cafes, hotels, restaurants and service providers offer WiFi connectivity but you may just miss that vital connection if you're moored or anchored away from the dock. Internet access afloat really adds to boating. Not only can you keep abreast of news and email, but it's a great source of entertainment, TV and media when allowing you take advantage of the latest entertainment services such as Netflix and Spotify. It can also be used to download the latest weather information. Free GRIB files are available to integrate with PC navigation programs to provide animated weather forecasts with wind, swell, pressure and temperature information.

Onboard internet connectivity can also help to entertain children and family when undertaking long passages. The ability to stream their favourite movies or Tv shows through numerous entertainment platforms can make those long journeys that little more entertaining.

Whilst on board, you can access the internet through 3G/4G systems, WiFi and satellite.

Digital Yacht make a range of high power WiFi systems which offer easy and cheap data access with ranges of up to 5NM. WiFi is cheap, global and fast and for many coastal sailors, it's ideal. Satellite provides a trans-ocean solution but at a high price and substantial running cost. The WL510 will integrate with your onboard PC system to provide internet access.

The Digital Yacht alternative 4G Connect system can provide low cost, reliable 3G/4G connectivity up to 20NM from shore which fulfils 99% of the recreational boating industry's requirement. It uses MIMO (multiple in/out) technology with dual antennas to deliver enhanced speed and range. It can also connect to another internet source (e.g. hi power WiFi or satellite) and switch between the connections. It creates a local WiFi (or wired) network on board for other devices to connect.

# 4G<sup>+</sup> Connect





## 4G CONNECT

4G Connect is a new 2G/3G/4G (LTE) internet access solution for use afloat. It utilises the latest MIMO technology with dual antennas for fast, long range access and incorporates a full function WiFi router so multiple devices can connect wirelessly. There is also a wired LAN port and WAN port - for connection to high power WiFi devices or satellite modems. WAN port can connect to WL510 hi power WiFi system for combination LTE/WiFi hotspot solution and the LAN port can be used for connection to iKommunicate navigation interface, allowing boat NMEA 0183/2000 data to be available on the WiFi network – ideal for iPad and tablet navigation.

4G Connect is available in two variants - The Standard model has built in antennas which will provide good performance when in port. The Pro model ships with two external hi gain antennas for exceptional long range performance and is the recommended solution for use afloat.

4G Connect has an easy to use interface and ships with a built in, low cost Vodafone roaming SIM. It is SIM unlocked so users are free to use any cellular provider they choose but the Vodafone solution offers the best maritime performance in Europe. Choose any available Vodafone plan - £25/50GB monthly 30 day tariff is attractive and offers excellent European coverage and roaming.

Operation is simple - turn on, connect to the password protected WiFi hotspot that 4G Connect creates and your device is online. Digital Yacht's WL510 hi power WiFi solution can also be connected to the WAN port for a choice between WiFi and 4G connectivity. iKommunicate can also connect to the LAN port providing boat NMEA data on the WiFi network for use with navigation apps.

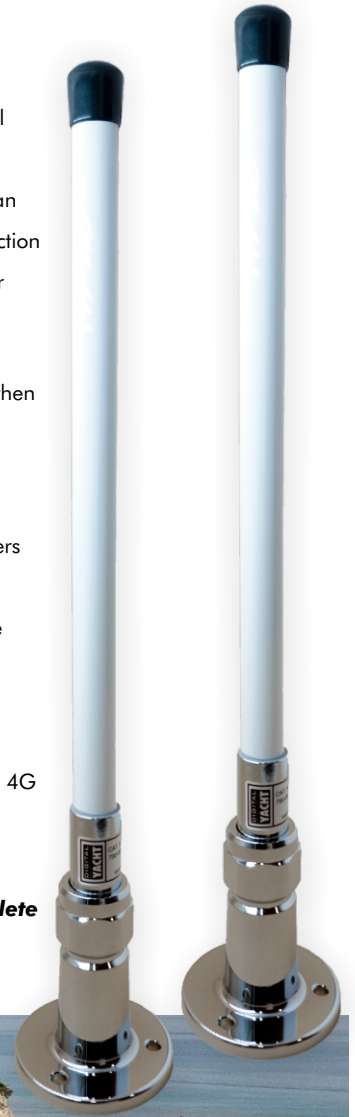

**4G Connect Pro comes complete with 2 high performance external antennas**



**4G CONNECT**





## WL510 HI POWER WIFI

The new internet for boats solution WL510 allows boat owners to connect to Wi-Fi hot spots so that their onboard PC's or equipment can connect to the internet. A great marine WiFi solution to get a fast internet on board. With internet connectivity on board you can download the latest weather or chart updates as well as having a mobile office on board. Most harbours and ports have either free or subscription based services available.

The system has a compact, DC powered below deck mounted 600mW booster/modem and external, hi-gain (12dBm) antenna with 10m (33ft) low loss LMR400 coax interconnect cable. The antenna measures 0.9m (2.95ft) and can be supplied with deck, mast and industry standard 1" x 14TPI mountings.

### WL510 HI POWER WIFI INTERNET ACCESS SOLUTION

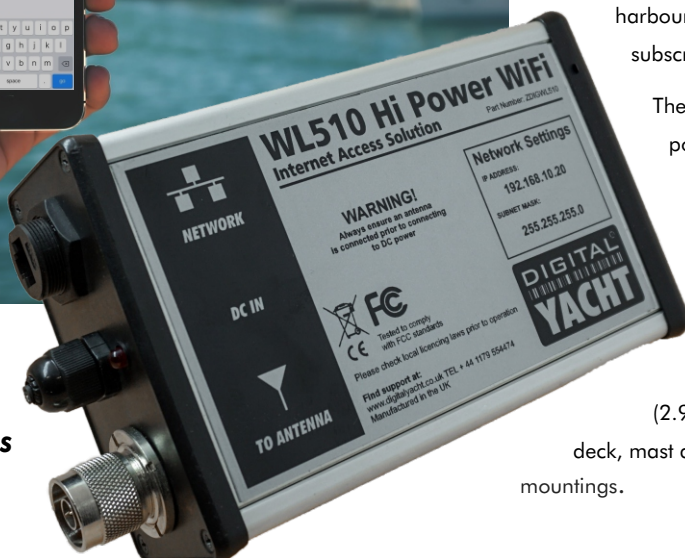

The WL510 modem connects to an on board PC through a regular RJ45 CAT5 network cable for simple driver free installation. Connect the WL510 to a router and everyone on board can share the long range wireless internet connection. Compatible with all popular operating systems; Windows XP/Vista/7, Mac OS X 10.3 (and higher) and LINUX, the WL510 supports 802.11b/g protocols as well as WEP/WPA/WPA2 encryption.

Wi-Fi range depends on many local factors, but Digital Yacht has seen ranges of up to 4-6 miles with this low cost system. In general, using an internal Wi-Fi adaptor typically found on a notebook, you'll be lucky to find the signal at the end of the dock, so if you plan to access the internet whilst on board, the WL510 could be the solution for you.

## IKCONNECT

iKConnect is a compact but powerful WiFi router for boats that provides a cost effective way to setup a wireless network on your boat. With direct connection to the boat's 12v DC, high gain 5dB antenna and a small foot-print, simple to install black box, iKConnect can be easily fitted to any vessel.

Pre-configured and optimised for use with our USB WL60 Long Range Wi-Fi antenna, the combination of an iKConnect with a WL60 is the lowest cost complete Wi-Fi solution that Digital Yacht have ever released and is an ideal way to connect your non-3G iPad or Android tablet to the internet when in harbour. With a simple web interface that controls the WL60 to scan and connect to the marina hotspot, iKConnect makes getting an internet connection on your boat a breeze.

This WiFi router for boats is also the perfect accessory for our latest iKommunicate Signal K gateway allowing mobile devices to wirelessly receive the Signal K or NMEA data anywhere on the boat. In fact the combination of iKConnect, iKommunicate and a WL60 allows the boat to have a single wireless network that provides both navigational data and internet access, without the hassle of switching wireless networks.

For ultimate long range Wi-Fi connectivity simply swap the WL60 for Digital Yacht's top of the range WL510 system which seamlessly connects to the iKConnect WAN socket.

### IKCONNECT



# AIS FOR SAFETY

In 2010, the IMO approved the use of AIS SARTs as an alternative to the traditional Radar SARTs. An AIS SART consists of a GPS receiver and an AIS Transponder that when activated, quickly gets a position fix and then transmits a special combination of AIS Messages 1 and 14 that can be detected by any AIS receiver or transponder within range.

AIS SARTs will gradually replace Radar SARTs on SOLAS vessels and larger pleasure vessels, but it is the new personal AIS SARTs (introduced via RTCM spec cC11901.0) that will be of most interest to yachtsmen. These small hand held devices transmit the same sort of messages as the AIS SART and can be fitted to a life jacket as a personal Man Over Board (MOB) device.

Unlike conventional MOB systems, these personal AIS SARTs continually transmit the exact location of the MOB, which in strong tides or bad weather is a major safety benefit. However, it is important to note if your existing AIS system and chart plotter/PC Software, will respond properly to the AIS SART messages.

When the AIS SART system was designed, compatibility with older equipment was achieved by using the existing AIS Message 1 – Class A Position Report. This ensured that all AIS compatible chart plotters would, at least, display an AIS SART as a Class A vessel. On these older chart plotters, no alarm would necessarily occur and the AIS SART was only seen if the MMSI number started with 97 (reserved for AIS SARTs).

On more modern chart plotters (2011 or later), the new Message 14 Safety Related Broadcast is also decoded, triggering a MOB type alarm and displaying the AIS SART on the chart with a special symbol, making it easy to identify and alerting everyone on board to the situation.

However, many older systems do not react in this way and just show the AIS SART as another Class A vessel, with no special alarms or symbols.

The good news for Digital Yacht customers, is that all Digital Yacht AIS units are compatible with the AIS SART messages. What is more, we have also developed a product called AIS Life Guard that is a low cost, low power, stand alone AIS SART Alarm.

So if your chart plotter is one of the many older systems that does not handle AIS SARTs very well, our new AIS Life Guard product will patiently monitor the NMEA0183 output of an AIS receiver or transponder and immediately sound an internal alarm and/or drive an additional external alarm.

## BENEFITS AND USES OF AN AIS SART

**Leisure:** Most coastal and ocean sailors have already embraced AIS and have a receiver or transponder fitted as standard. MOB situations are shown in all sailing surveys as being one of the major concerns of recreational boaters.

**Offshore:** Workers on rigs and offshore structures can carry a personal AIS SART. Monitoring crew will remain an important part of any health & Safety risk assessment and lone workers on rigs have substantial risks attached to their duties. On large structures there would be little indication of a person falling into the sea.

**Commercial & Naval:** Like offshore, large ships and naval vessels would have little indication of a crew MOB situation.

S1000 AIS SMART SART





## AIS LIFEGUARD

The AIS Life Guard is the world's first Man Overboard AIS alarm designed to work with the new generation of AIS SARTs that have recently been approved for global use by the IMO. Many existing AIS compatible chart plotters do not fully support AIS SARTs but with the AIS Life Guard connected to an AIS transponder or AIS receiver, you can have a complete working AIS SART man overboard system.

Operation is automatic, simply connect the two wire NMEA input on the AIS Life Guard to the NMEA output of your AIS and it will listen to all AIS traffic. As soon as an AIS SART transmission is detected the AIS Life Guard will sound its internal 95dB alarm and display a red warning light. For larger installations, it can also be connected to an external alarm (not supplied) so that the whole boat is immediately alerted.

The AIS Life Guard detects both message 1 and message 14, the two AIS messages reserved for AIS SARTs and will also give a short three beep alarm if it detects an AIS SART test message, great for checking correct operation of your AIS SARTs prior to a voyage. All Digital Yacht AIS receivers and transponders are compatible with the AIS Life Guard and it is designed to operate on 12v or 24v DC systems.

## AIS MOB100

Digital Yacht have teamed up with SIMY to create World's smallest AIS MOB Beacon (personal SART). SIMY is a division of leading space company Syrlinks (designers of the Rosetta probe) who specialise in miniaturising and low power electronics.

**AIS MOB100**

**AIS LIFE GUARD**

The new MOB100 is designed for manual activation or can be attached to an automatic inflation lifejacket onto either a strap or the lifejacket inflator which will allow it to automatically activate when the life-vest inflates. The unique cover design requires just a 1cm downward movement created by the strap and lifejacket inflation to auto activate and deploy the spring antenna. On foam filled life-vests, the unit would be fitted to the outside and set up for manual activation.

The AIS MOB100 Beacon incorporates a super sensitive 72 channel GPS and AIS SART transmitter. When activated, it sends the casualty's current location as an AIS transmission which can be detected by any vessel equipped with an AIS transponder or even a simple AIS receiver. All Digital Yacht AIS products are fully compatible with AIS MOB/SART transmissions. The AIS device or plotter display shows a unique MOB target identifier to position the MOB onto the navigation system. Optional devices like Digital Yachts AIS Lifeguard can also automatically sound an audio alarm to alert the crew of the emergency MOB situation. Coast and monitoring stations can also pick up the signal which is identified using a unique signal as a MOB distress situation. Range is typically 5-10nm depending upon sea conditions. When activated, the MOB position is sent 8 times a minute as a priority AIS SART message and the strobe LED flashes to aid night time recovery. If activated accidentally, the MOB100 can be physically reassembled and reset.

The MOB100 has a 7 year battery built in which will operate for at least 24 hours continuously when activated. It's totally waterproof and has a test facility to check operation as required.



# ONBOARD ENTERTAINMENT

## TV ONBOARD

Enjoy terrestrial TV while boating – great for some down time. TV onboard is becoming more and more popular among boat owners. However, TV entertainment on board differs to that on land and requires a secure and efficient reception to ensure the best picture quality and channels available. Digital Yachts DTV series TV antennas provide sensitive DTV reception up to 30NM offshore providing the ideal solution to TV entertainment afloat.

## WIFI ONBOARD

For media and TV streaming, take a look at 4G Connect for access via the internet to your favourite online entertainment from iPlayer, Netflix, Spotify, Hulu and Amazon.



4G CONNECT



DTV100 MARINE ANTENNA



## DTV100

Digital terrestrial TV (even in HD) can now be received while afloat with a new TV antenna from Digital Yacht. The slick DTV100 TV antenna picks up national free to view HD TV signals and allows a range of popular channels to be viewed on board.

The DTV100 is a high performance, omni-directional TV antenna for boat providing great reception of the latest digital, terrestrial TV signals while afloat.

The Digital Yacht DTV100's super sensitive design and hi gain amplifier, suck in even the weakest of signals. It's omni-directional too so requires no complicated aligning plus it will also provide a feed for an FM stereo radio.

Most countries are now transmitting national free to view digital TV channels, some even in HD, and with the DTV100's sleek 280mm (11") diameter, high sensitivity, omni-directional antenna design and fully adjustable, high gain, powered amplifier (-7dB to 29dB), you can tune in to all of them with perfect digital reception.

### DTV100 MARINE HD TV/FM ANTENNA

Start taking advantage of free HD digital TV entertainment today and enjoy a few home luxuries on board.

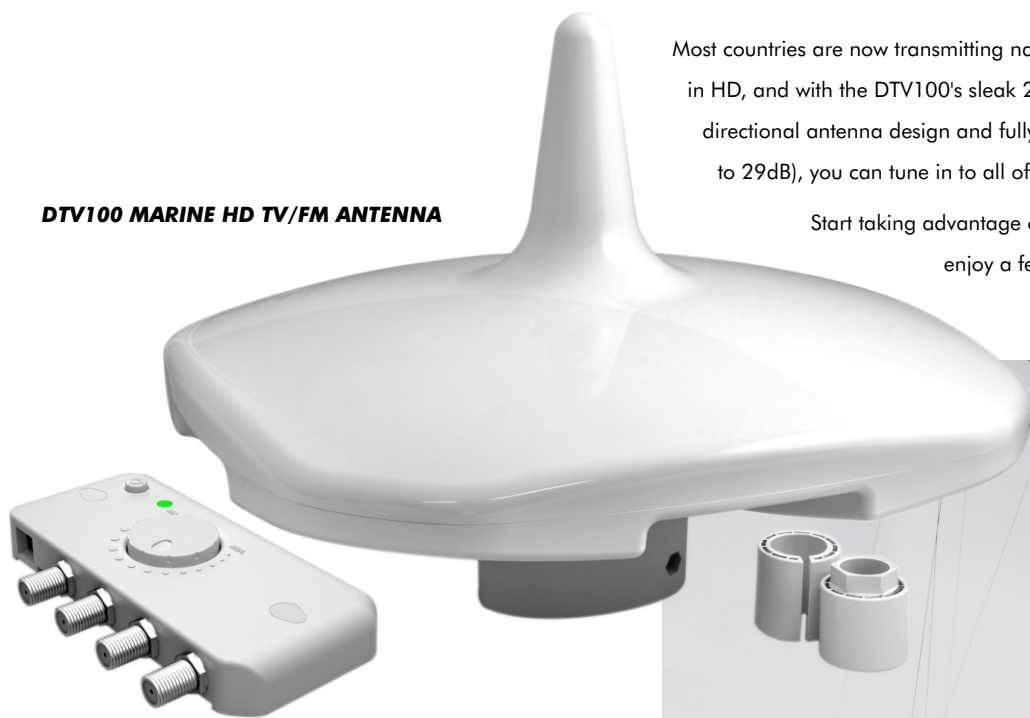

- Below deck amplifier and splitter provides -7 to 29dB gain adjustment.
- 12/24V operation
- Optional amplifier provides 2nd TV output for multi cabin installation

## DTV200

This model comes complete with DTV100 and includes the dual TV output amplifier and 20m cable.

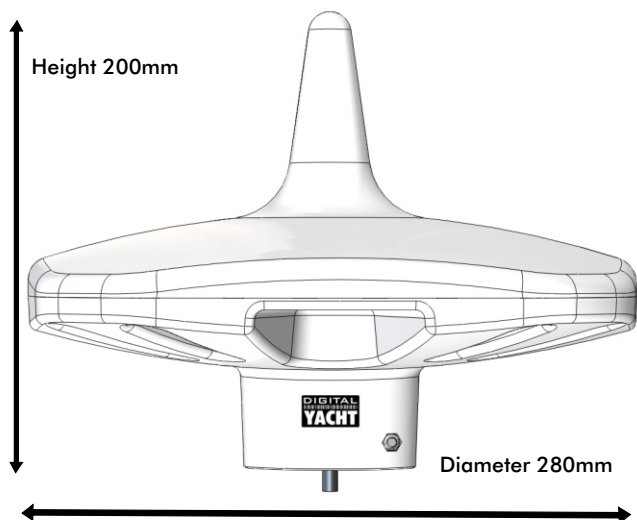



**SYSTEM PACKS FROM DIGITAL YACHT**

Building a system with Digital Yacht is easy with these Digital Yacht Solutions ideas. Integrate AIS, sensors, internet connectivity and iPads or tablets for a true wireless navigation and communication solution for your boat. Add a PC with software for below decks, chart table or bridge navigation. Use our range of interfaces to act as a gateway between legacy and current networked systems. DY Solutions make it easy to integrate 3rd party products too.

Digital Yacht can help build AIS Solutions where we can offer Class B transponders for multiple applications from jetski and tender tracking right through to iPad and tablet based navigation with our AIT3000.

PC Solutions provide a powerful yet value based big screen navigation solution integrating our AIS and sensor products with Aqua Compact Pro and our Navionics based SmarterTrack software.

iSeaSense is the systems approach for our range of instrumentation sensors which now includes GPS, depth, speed, wind and compass. These can now be integrated into NMEA0183 and NMEA2000 systems and provide a complete on board solution with tablet and PC connectivity too.



**WND100**

**Example of Digital Yacht products used to create a PC navigation system with GPS, Wind and AIS**



**AIT2000**

**AQUA COMPACT PRO +**

**SMARTERTRACK SOFTWARE ON PC MONITOR**

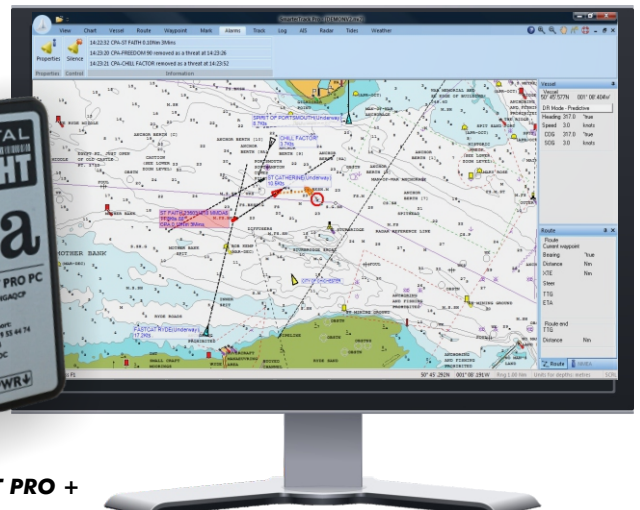



## 4G CONNECT PRO LTE WITH HI POWER WIFI & NMEA INTERFACE

This solution integrates the WL510 hi power WiFi system with 4G Connect allowing both LTE and WiFi hotspot internet access.

iKommunicate, our universal NMEA0183, 2000 and Signal K interface can also connect to the LAN port providing boat NMEA navigation, instrumentation and engine data on the WiFi network for use with navigation apps.



**4G CONNECT**

## 4G CONNECT PRO LTE WITH HI POWER WIFI & NMEA INTERFACE



**iKommunicate Nav Interface**

**4GConnect Pro System**

**WL510 WiFi Access**



**4GConnect Standard System**

**4G CONNECT STANDARD  
LTE INTERNET ACCESS  
AFLOAT**

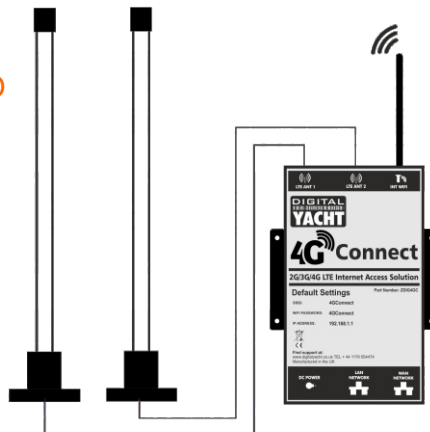

**4GConnect Pro System**

**4G CONNECT PRO LTE  
INTERNET ACCESS AFLOAT**

## NOMAD PORTABLE CLASS B AIS TRANSPONDER

## AIT1500 CLASS B AIS TRANSPONDER

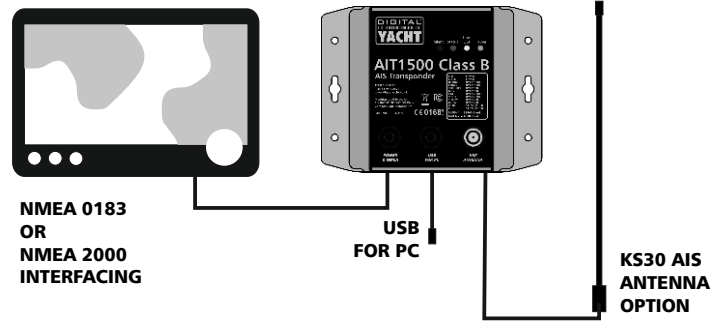
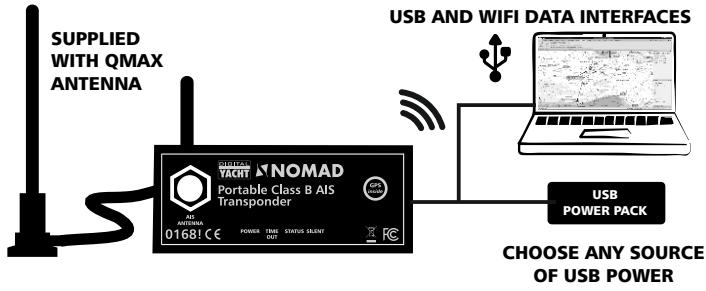

### NOMAD PORTABLE CLASS B AIS TRANSPONDER

Nomad is a full function Class B AIS transceiver (transmit and receive) with built in wireless interface designed to allow iPads, tablets, smartphones and PCs to become a full function navigation device with a compatible app. It's self powered from any USB style connection so can be used with 3rd party USB battery packs, PCs or a simple USB 12V cord as a totally portable AIS transponder. With a built in GPS, it will provide the application with GPS and AIS data for real time navigation as well as transmitting AIS data to other nearby vessels.

### AIT1500 CLASS B AIS TRANSPONDER

A simple, yet high performance Class B transceiver with integrated GPS antenna. Ideal for use on board smaller vessels like RIBs, center consoles or even jetskis, tenders or kayaks. Choose from either a NMEA0183 or NMEA2000 interface.

Both models also have a USB interface.

Matching SPL1500 VHF-AIS antenna splitter also available or just connect to a dedicated VHF/AIS antenna like the KS30 1m GRP whip.

### AIT2000 CLASS B AIS WITH ZEROLOSS VHF-AIS ANTENNA SPLITTER

The AIT2000 comes complete with an external GPS antenna so is suitable for mounting on all types of boat. It has NMEA0183 and NMEA2000 interfaces as well as a USB PC/MAC connection.

There is also a 2nd NMEA output to provide a GPS feed for a DSC VHF radio. The AIT2000 can also be fitted with a silence switch to mute transmissions.

The matching, patented, ZeroLoss SPL2000 allows the main VHF antenna to be shared with VHF and AIS or alternatively, just connect to a spare VHF antenna.

### AIT3000 WITH INTEGRATED ANTENNA SPLITTER AND WIFI

The AIT3000 is a sophisticated one box solution with Class B AIS transponder, VHF-AIS antenna splitter and built in WiFi server for tablet and iPad connectivity. Stream AIS and GPS data wirelessly to connected devices. Optional LifeGuard AIS SART alarm can also be utilises (also compatible with AIT1500/AIT2000).

## AIT2000 CLASS B AIS WITH ZEROLOSS VHF-AIS ANTENNA SPLITTER

## AIT3000 WITH INTEGRATED ANTENNA SPLITTER AND WIFI

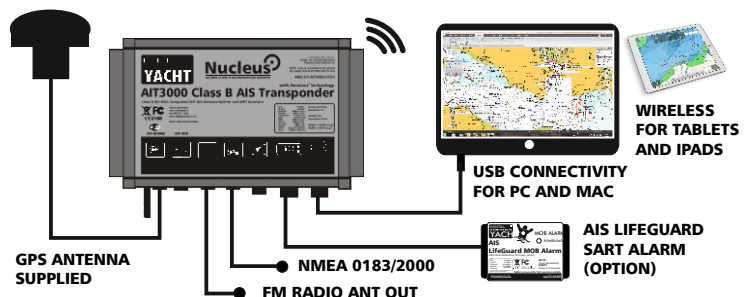
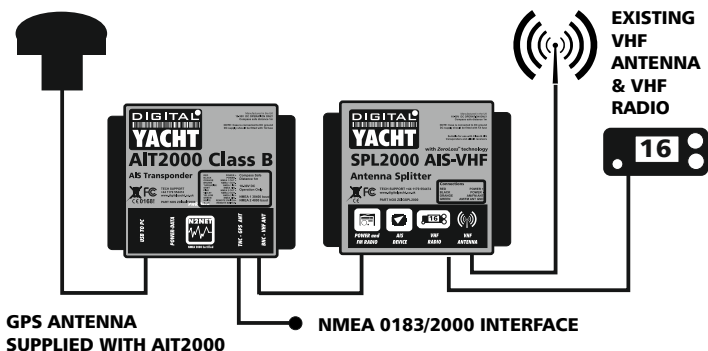



**WIND PACK**

A great starter pack for any sailor looking to add wind instrumentation. WindSense has a very high quality mast head unit which is wired to the below deck WiFi box - providing a feed for up to 7 connected devices.

Utilise your tablet or smartphone as an instrument display with 100's compatible apps. NMEA output for traditional instrument displays and input for any compatible NMEA0183 data.

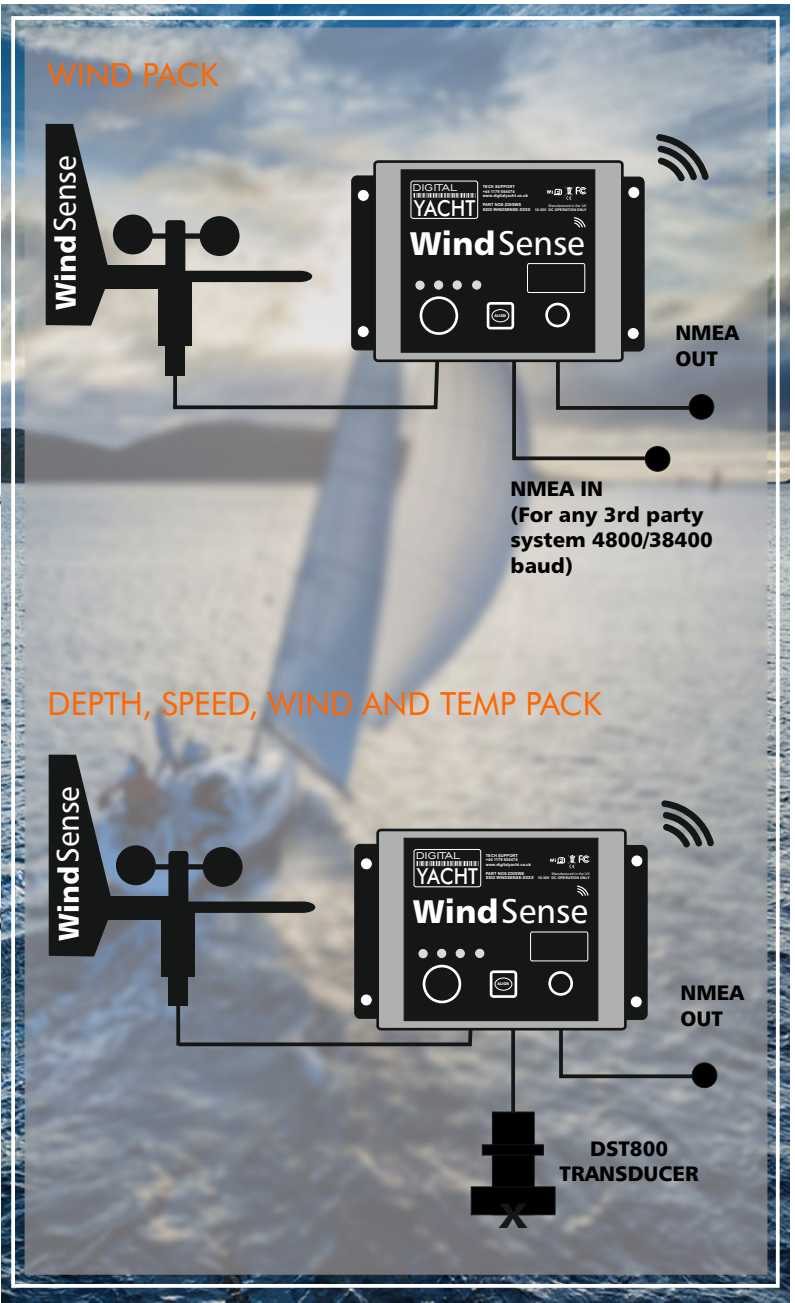

**DEPTH, SPEED, WIND AND TEMP PACK**

All the features of the Wind pack but with the addition of a smart depth/speed/temp transducer to provide a complete wind, speed, depth and temperature based solution.

With the addition of boat speed information, compatible apps can calculate true wind speed and angle as well as VMG.

**ADVANCED INTEGRATED PACK WITH AIS, GPS AND INSTRUMENTATION**

A sophisticated system with a Class B AIS transponder integrated to provide AIS and GPS data as well as instrumentation. This system is expandable using a NMEA2000 backbone and the iKommunicate interface can also act as a gateway for other NMEA2000 bus data.

The iKConnect WiFi router can support up to 200 connected devices and also offers a WAN port for connection to the internet via optional 4G or WiFi devices.

**ADVANCED INTEGRATED PACK WITH AIS, GPS AND INSTRUMENTATION**

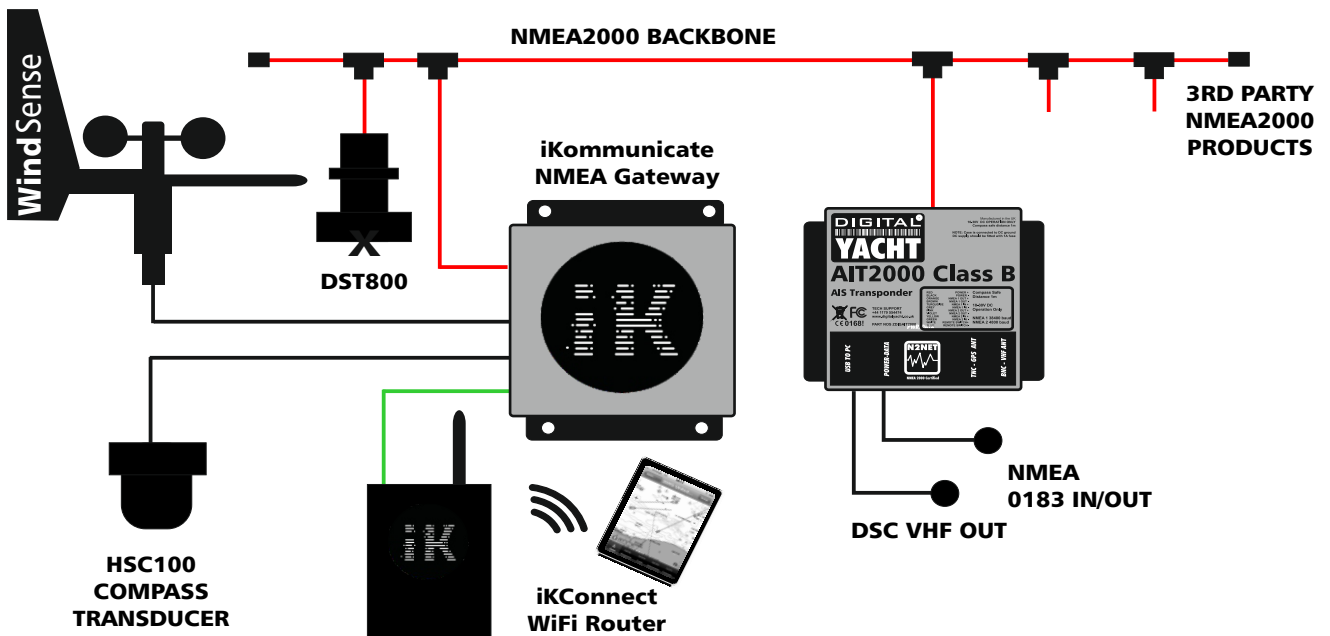

## EASY PC NAV SYSTEM WITH GPS

Digital Yacht's latest Aqua Compact Pro PC brings affordable and reliable PC based navigation to boats. With direct DC operation, it boasts the latest Intel 7th generation technology. SmarterTrack navigation software utilising Navionics charting is preloaded for a sophisticated yet simple to use chart plotter system with 15" display (17, 19 and 22" options available). The GPS150 DualNav sensor provides GPS & GLONASS positioning inputs with typical sub 1m accuracy. Additional NMEA devices can connect via the USB NMEA adaptor.

## PC NAV SYSTEM WITH GPS, WIND AND AIS CLASS B TRANSPONDER

This system builds on the basic package and includes AIS (Class B transponder) plus a WND100 wind transducer integrated too for wind speed and angle information. SmarterTrack software offers an advanced AIS display with colour coded targets and alarms for CPA and TCPA. The AIT2000 allows interfacing to traditional chart plotters with a NMEA0183 and NMEA2000 interface. There is also a GPS NMEA output for DSC VHF's.

## EASY PC NAV SYSTEM WITH GPS

## PC NAV SYSTEM WITH GPS, WIND AND AIS CLASS B TRANSPONDER

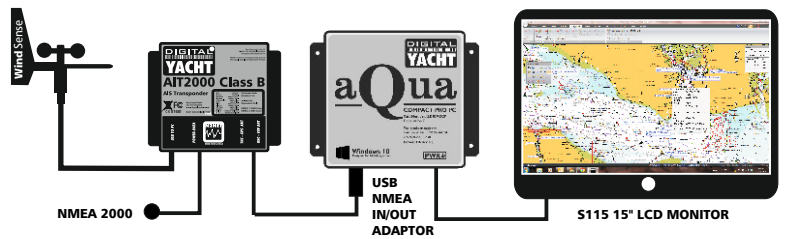
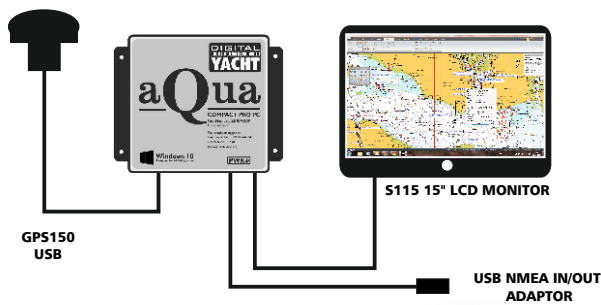

## PC NAV SYSTEM WITH GPS, AIS & iKOMMUNICATE WIFI INTERFACE

iKommunicate plus the iKConnect WiFi router adds full NMEA2000 integration to the system with possibilities for engine monitoring too. The wireless interface can also support multiple tablets and iPads with a choice of 100s of different charting and instrument display apps. The Aqua PC can also wirelessly connect to the iKConnect router.

## PC NAV SYSTEM WITH GPS, AIS & iKOMMUNICATE WIFI INTERFACE





# DIGITAL DEEP SEA



Commercial and professional users demand the highest quality and performance, but have tough budgetary requirements. Our engineering team has worked hard to design products which offer excellent value and are easy to install to minimise total in service costs.

Digital Deep Sea products are designed for the professional market including commercial shipping, fishing, workboat, super yacht and naval applications. They're built tough for a demanding environment yet share the same innovative designs and great value offered by our leisure products. Digital Deep Sea builds on Digital Yacht's core areas of technology including AIS and wireless communications to produce navigation and communication systems for these demanding users. Products such as our CLA2000 Class A AIS and our AIS SART also carry Wheelmark IMO compliance for mandated installations. Our Aqua PC products can also find a place aboard any commercial installation and bring pc benefits to the high seas.



## CLA2000 CLASS A AIS



**S1000 AIS SMART SART**







## CLA2000

As previously mentioned (page 9 - AIS transponders) Digital Yacht's new CLA2000 is the ultimate SOLAS and inland waterway globally approved Class A AIS transponder. It is water and weather proof to IP67 and has a full integrated 5" hi-res colour display supporting a wide range of functionality including electronic chart navigation with optional C-Map MAX charting and AIS target management.

### DISPLAYS

Easy to use, icon based user interface makes selecting function and entering data easy using the rotary knob as well as cursor button control – even in rough conditions. Target lists provide name, type, range, bearing, CPA and TCPA filterable list with drill down static vessel data at the push of a button. Icons make target identification easy. The unit features built in base mapping for easy referencing of target positions. There is also the option for detailed mapping with C-Map MAX charting on the micro SD card. Plot display also shows easy visualisation of target bearing, relative bearing and distance and user configurable alarms for CPA (closest point of approach) and TCPA (time to CPA) can also be set. Advanced GNSS position display shows source and satellite status, where user can select external or internal GNSS positioning source.

**CLA2000**

### ADVANCED AIS SART/MOB CAPABILITY

The CLA2000 has optimised software for detecting AIS SART and MOB devices with a dedicated icon for this class of AIS. An automatic alarm is activated on detection of an AIS SART beacon activation. The target plot display will also calculate relative bearing of the device for easy visualisation of the target and rescue.

### WIRELESS INTERFACE

The CLA2000 has an integrated wireless interface for sending AIS and position data to smart phones, tablets, PCs and MACs for use with 3rd party charting and navigation apps. It supports client mode where it can connect to an existing wireless network or AP mode where devices can connect directly to the CLA2000. Up to 5 simultaneous/connected devices are possible.

### PILOTLINK

PilotLINK is a wireless interface for Class A AIS Transponder. All non-WiFi Class A transponders share a common "Pilot Plug" connector that PilotLINK connects directly to via a 1m cable. PilotLINK then creates a wifi navigation network on board the vessel which allows AIS and GPS data from the Class A to be sent directly to any connected mobile devices such as phones or tablets.



PilotLINK is stand alone and can operate from its internal, user replace-able, dry battery (PP3) for up to 15 hours.

Alternatively, it can connect via a standard mini USB connector to any USB style power pack or AC/DC USB power adaptor that are readily available from many 3rd parties.

PilotLINK is compatible with a wide variety of apps and PC programs. iAIS is a free of charge app from Digital Deep Sea which gives a basic AIS radar type display and target information. It's also compatible with iSailor and iNavX and many other 3rd party apps available through the Apple App store or Google Play on Android. PilotLINK can also interface with a PC or MAC. Popular navigation programs such as SmarterTrack, SeaPro, RosePoint and MaxSea for PCs or macENC for a Mac are all compatible.



# NOTES

OUR IDEAS FOR YOU

A large grid of graph paper for taking notes, consisting of 20 columns and 30 rows of small squares.



SAIL BOAT



MOTOR BOAT



SUPERYACHT



WORK BOAT



SPORT FISHING



COMMERCIAL FISHING

Follow our daily newsfeed at [www.digitalyacht.net](http://www.digitalyacht.net)



## NEXT GENERATION MARINE ELECTRONICS

Find us at:

**Digital Yacht**

TEL +44 117 955 4474

Email: [sales@digitalyacht.co.uk](mailto:sales@digitalyacht.co.uk)

[www.digitalyacht.co.uk](http://www.digitalyacht.co.uk)

**Digital Yacht America**

TEL +1 978 277 1234

Email: [sales@digitalyachtamerica.com](mailto:sales@digitalyachtamerica.com)

[www.digitalyachtamerica.com](http://www.digitalyachtamerica.com)

Designed and manufactured in

