

COSTAL INTERNET BROWSING & SURFING UP TO MORE THAN 20 MILES FROM THE COAST

GLOMEX
The best in marine antennas



weBBoat[®] Plus 5G

NOVEMBER 2022

weBBoat[®] and costal internet are registered trade marks property of Glomex S.p.A.
Netflix, Prime Video, NOW TV are property of the respective owners.



INDEX

▶ COMPANY PROFILE	4
▶ WHAT IS WEBBOAT®?	6
▶ WHAT DOES WEBBOAT® DO?	7
▶ NEW MIOT 5G GLOMEX ROUTER BOARD	8
▶ GLOMEX WEBBOAT® COASTAL INTERNET APP	10
▶ CHOICE GUIDE	12
▶ WEBBOAT® PLUS 5G (IT1205PLUS, IT1205PLUS/BK)	14
▶ WEBBOAT® 4G PLUS EVO (IT1004PLUSEVO, IT1004PLUSEVO/BK)	15
▶ WEBBOAT® 4G LITE HIGH SPEED (IT1104HS, IT1104HS/BK)	16
▶ WEBBOAT® 4G LITE EVO (IT1104EVO, IT1104EVO/BK)	17
▶ WEBBOAT® LINK PRO 5G EXT (IT1405PROEXT)	18
▶ WEBBOAT® LINK PRO 5G (IT1405PRO)IT1304	19
▶ WEBBOAT® LINK PRO (IT1304PRO)	20
▶ WEBBOAT® LINK PRO EXT (IT1304PROEXT)	21
▶ WEBBOAT® LINK HIGH SPEED (IT1304HS)	22
▶ WEBBOAT® LINK HIGH SPEED EXT (IT1304HSEXT)	23
▶ WEBBOAT® LINK (IT1304)	24
▶ WEBBOAT® LINK EXT (IT1304EXT)	25
▶ DATA TRANSMISSION	26
▶ OPEN-SEA TESTING	28
▶ ANTENNAS GAIN PATTERNS	30
▶ WEBBOAT® RANGE CONFIGURATION E METAL BOAT INSTALLATION	33
▶ WEBBOAT® EXTENDED SYSTEM	34
▶ SOME WORDS ABOUT INTERNET	36

COMPANY PROFILE



MADE IN ITALY

ABOUT US

Glomex is an Italian company and a world leader in the production of antennas and entertainment systems for the marine industry. It was founded in 1984 in Ravenna, with the ambition to improve the reliability of maritime telecommunications and offer its customers product and service quality, professionalism, technological innovation and style.

Nowadays, Glomex is a strong company that has established business partnerships all over the world, with its own distributors and with the largest international boatbuilders. Paying attention to the quality of raw materials and production processes, Glomex has interpreted the real needs of professional and amateur customers, always guaranteeing radio contact with land, reception of satellite and terrestrial TV signals, stable and fast internet connection. We do everything to carry on our motto:

You are never alone on the water!



WE TEST ALL PRODUCTS AT SEA



TLT (Test Lab Tested) is the abbreviation you see on Glomex products, which before being put on the market have undergone rigid quality tests in the marine environment, to test their actual performance at open sea, aboard our Test Lab. Test Lab 3 is a boat arranged with all required features to perform a direct test on Glomex products reliability. Before being tested on board the Test Lab, Glomex products are required to pass resistance tests (UV-ray exposure, mechanical, electric, electronic and temperature) run for one year in the company laboratories.

EXCLUSIVE LIFETIME WARRANTY



Glomex is the only company in the nautical sector that offers a lifetime warranty on most of its products: VHF, CB, Omnidirectional Terrestrial TV, AM/FM, ORBCOMM, AIS, Glomeasy, and mobile phone, Internet and related mounts.

ETHICS AND SUSTAINABILITY

In Glomex we place a high value on ethical production and sustainable development. To reduce the use of fossil fuels, nearly 15 years ago we installed photovoltaic panels, approaching 90% energy autonomy. In addition, the lifetime warranty provided by Glomex has a double benefit: besides the economic benefits, it reduces waste, over consumption, counteracts the growing need for waste disposal and favors recycling. When you buy Glomex, you are certain of the high quality of the materials and know that you are contributing to environmental sustainability, exposure, mechanical, electric, electronic and temperature) run for one year in the company laboratories.

WHAT IS weBBoat®?

Today, advancements in technology allow us to stay connected to the world, our friends and family, and to our interests while on the go. Although these technologies are readily available and easy to use, sometimes location can cause loss of connectivity as on the water.

Thanks to the super-fast 5G/4G/Wi-Fi built-in router, internet connectivity can be retained while boating whenever and where ever you go.

The weBBoat® was developed to help with these issues while withstanding the harsh marine environment while enjoying our time on the water. Social networking, video strea-

ming, chatting, and email can all be done approximately for more than 20 miles from the coast (depending on the model and transmitter positions.)

The weBBoat are 5G or 4G and Wi-Fi Coastal Internet integrated systems with automatic firmware updates and automatic App updates so you always have the best performance without any need to contact service.

The weBBoat® has the ability to send diagnostic data to Glomex technical support to resolve any problems that may arise.



WHAT DOES weBBoat® DO?

There are many factors that can cause disruption to either the cellular or Wi-Fi network while you are underway such as the size of your phone's internal antenna, boat layout, antenna placement, humidity, etc. Thanks to the advanced technology used, the weBBoat can help prevent or solve these connection problems.

Equipped with powerful, high gain 5G/4G antennas, a 5G or 4G router (depending on the model) developed specifically for the marine environment, weBBoat® integrated systems receive 5G

or 4G signals up to more than 20 miles from the coast (depending on the model) and redirect them inside the boat, creating a private, secure and fast private Wi-Fi network to which up to 32 different devices can be connected. In addition, when the boat is in harbor, weBBoat® receive the Wi-Fi signal from the marina or restaurant etc. present in the area with a signal reception range doubled compared to the previous version.

In particular, the weBBoat® 5G range has an innovative router and software designed for use at sea on boats of all kinds. It is not a router for an office or home use where conditions of use are different, which is why it was developed and tested in the 24/7 Gloomex Test Lab 3.

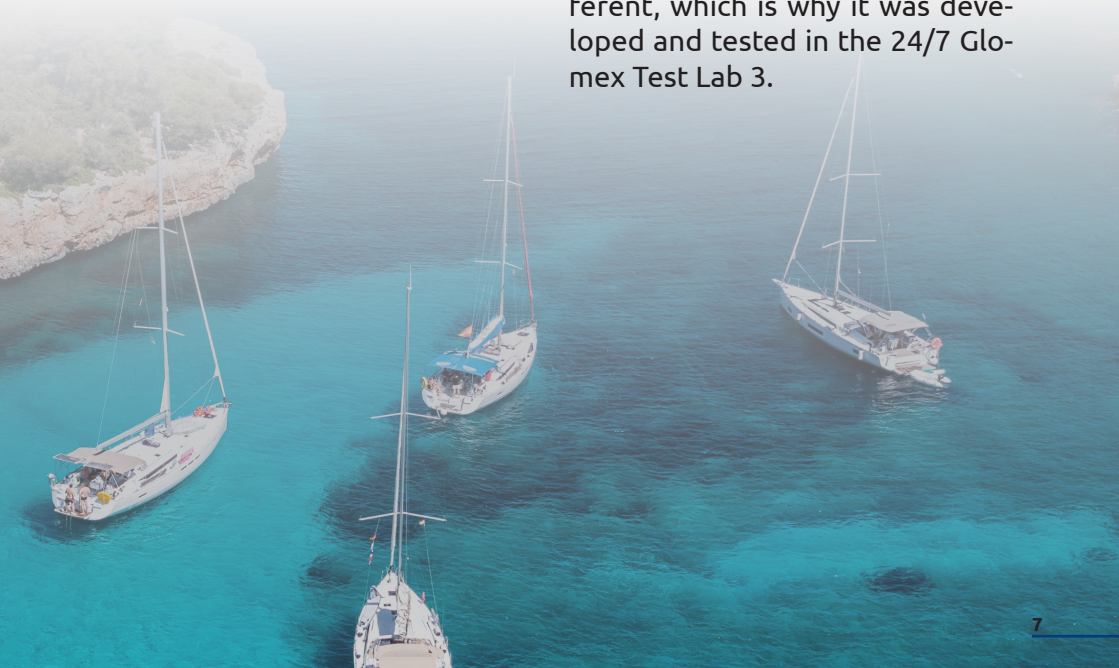

New MIoT 5G Glomex router board

NEW GLOMEX MIoT 5G ROUTERBOARD

The Glomex Coastal Internet 5G models , weBBoat Plus 5G (code IT1205PLUS), weBBoat PRO 5G (code IT1205PRO), weBBoat Link PRO 5G (code IT1405PRO) and weBBoat Link PRO EXT 5G (code IT1405PRO), are equipped with the revolutionary Glomex MIoT platform Routerboard, working all over the world except in China, with a super-powerful processor, that highly increases the connection speed compared to other existing internet systems.

The App automatically recognizes the 5G unit and shows the specific firmware.

Technical Specifications

- ▶ **DC power:** 9/30 Vdc
- ▶ **Ethernet ports:** 2 (1 WAN + 1 LAN)
- ▶ **5G:** up to 2.5Gbps in download
- ▶ **LTE CAT16 DWN:** up to 1Gbps in download
- ▶ **LTE CAT18 UPL:** up to 200 Mbps in upload
- ▶ **WCDMA:** Max 42Mbps in download
- ▶ **Wireless:** IEEE 802.11b/g/n
- ▶ **Dual Wi-Fi:** 2.4GHz/5GHz
- ▶ **Functions in:** Access Point mode e Station mode
- ▶ **CPU:** Arm Cortex-A7 800MHz
- ▶ **RAM:** 256MB DDR3
- ▶ **5G NR:** n1/n2/n3/n5/n7/n8/n12/n20/n25/n28/n38/n40/n41/n66/n71/n77/n78/n79 - n48 in process
- ▶ **LTE-FDD:** B1/B2/B3/B4/B5/B7/B8/B12(B17)/B13/B14/B18/B19/B20/B25/B26/B28/B29/B30/B32/ B66/B71
- ▶ **LTE-TDD:** B34/B38/39/B40/B41/B42/B43/B48 LAA: B46 (supports only 2 × 2 MIMO)
- ▶ **WCDMA:** B1/B2/B3/B4/B5/B6/B8/B19
- ▶ **Operating temperature:** from -40°C to 75°C

5G CAT16 MODULE

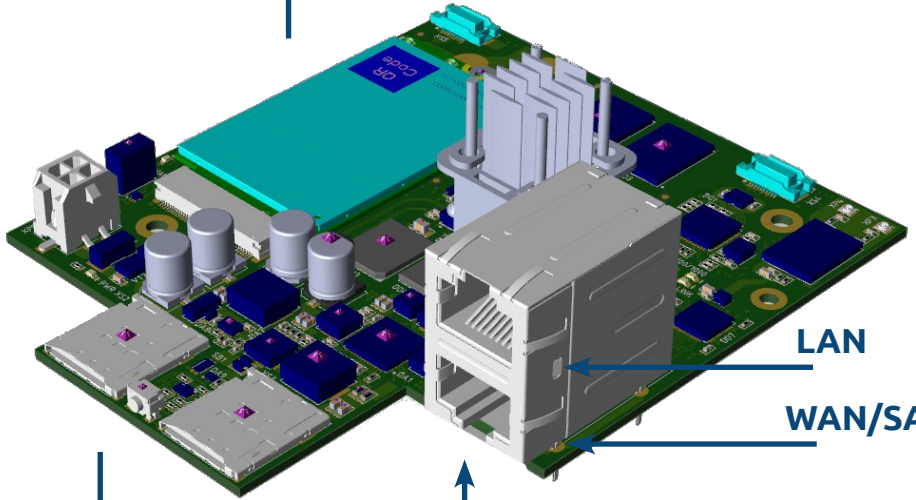

LAN

WAN/SAT

DUAL ETHERNET

DUAL SIM



Glomex weBBoat® Coastal Internet App

weBBoat® 5G models use the same App as weBBoat 4G integrated internet system, but with a specific firmware, updated graphics and more user-friendly. The App automatically recognizes the 5G device and shows the specific firmware.

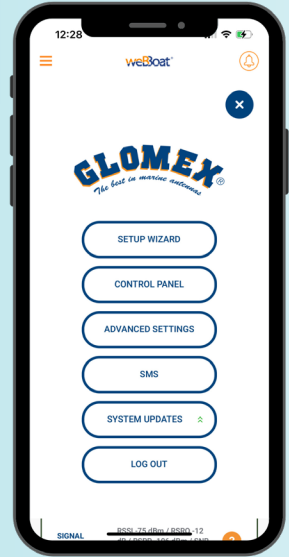

Menu

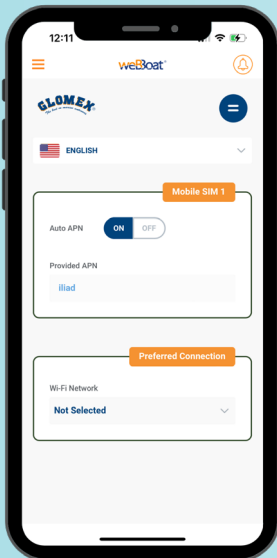

Setup wizard

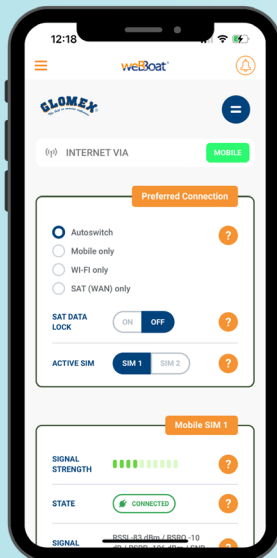

Control panel

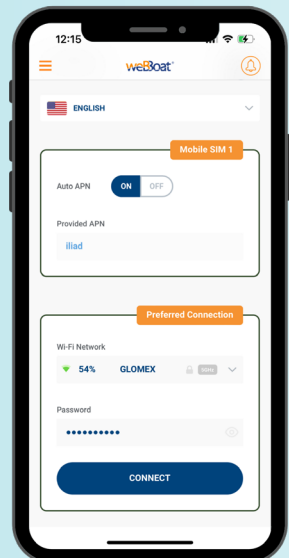

Automatic APN



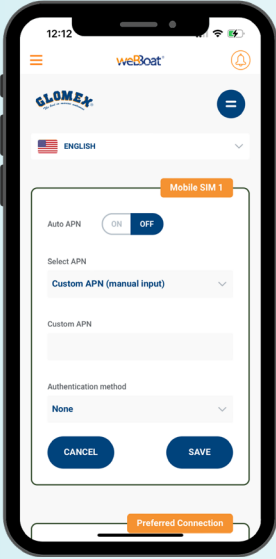

Custom APN

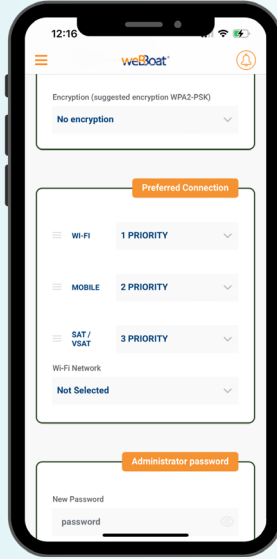

Autoswitch priority

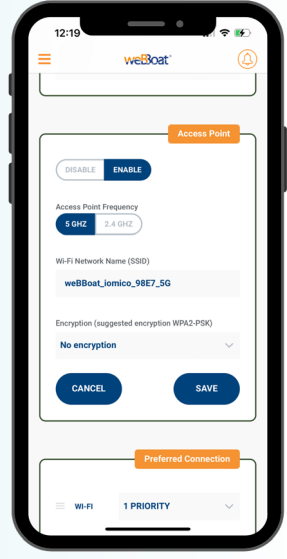

Access point



Speed Test - Troubleshooting



SMS Management

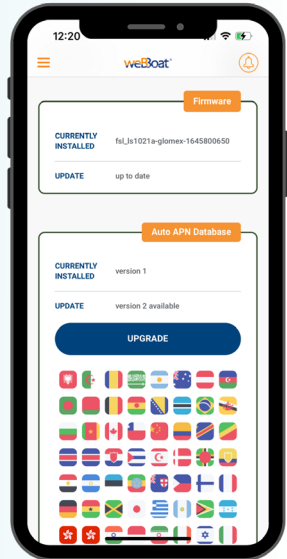

Firmware upgrade



weBBoat® Plus 5G

DUAL SIM 5G/4G/Wi-Fi COASTAL INTERNET outdoor system to surf the web up to over 20 miles from the coast

Category: All-in-One outdoor unit

Subcategory: Dual SIM / over 20 miles

Code: IT1205PLUS

Code: IT1205PLUS-BK



weBBoat® Plus 5G is the new WORLDWIDE* Dual SIM 5G/4G/Wi-Fi All-in-One Plug & Play Coastal internet system to get internet on board and a secure Wi-Fi hotspot inside and outside the boat thanks to the in-built 5G/4G and Wi-Fi antennas for fast connection over 20 miles from the coast. Now, you have an ultra-fast connection download speed on board: up to 2.5 Gbps. Moreover, if you sail in an area with no 5G signal coverage, the LTE CAT 16 unit allows you to have a 4G connection speed up to 1Gbps. 5G offers a connection with the same level of fibre connection, but totally wireless and therefore perfect to be used on board.

Inside the dome, there are 4 x high performance 5G and 2 x 2.4/5GHz MIMO Wi-Fi antennas for optimizing the speed of data transfers with a huge increase on the connection speed. That means that you can either watch streaming TV channels and platforms such as Netflix or Amazon Prime offshore, or work remotely from your boat, using internet connection as like you would be on the mainland.

Equipped with the new revolutionary Glomex MIoT Routerboard platform with a super-powerful processor, that highly increases the connection speed compared to other existing internet systems.

Some of the weBBoat® Plus 5G main features are:

- ▶ Completely new firmware and user interface with new features
- ▶ Carrier aggregation. The new weBBoat Plus 5G takes advantage of the flexible bandwidth option in LTE and adds the capability to combine multiple bands of the carrier into one big channel. It can access a much bigger data pipe and therefore the achievable data rates improve significantly. Carrier aggregation is supported by improvements to the unit technologies, to make the overall spectrum usage more efficient
- ▶ Automatic APN: Easier and Faster configuration with the automatic selection of your SIM card carrier APN.
- ▶ Optimized to implement any type of IoT solution
- ▶ Using the Glomex weBUI or App you can manage and configure any aspect of your onboard internet connection system. You can also read/send SMS and check the SIM credit and the cellular internet data consumption.
- ▶ Priority function: to choose which connection type is used and in which assigned priority order. Typically, the highest priority source will be the cheaper high bandwidth connections (marina Wi-Fi, then Cellular) with the lowest priority source being the more expensive satellite internet connection. With weBBoat® Plus 5G you can choose also to enable only one internet connection methods, for example the marina Wi-Fi to reduce the cellular or satellite internet data consumption and costs.
- ▶ Encrypted real-time peer-to-peer connection for remote set-up & service.
- ▶ In-built speed-test feature.

OPTIONAL ACCESSORIES



▲ V9124 stainless steel mount



▲ ITM001 nylon mount for cross tree



▲ N9173TV Stainless steel masthead mount (diameter 25 mm/1)



▲ ITAP001 Access point

weBBoat® 4G Plus EVO

DUAL SIM 4G/WI-FI COASTAL INTERNET outdoor system for surfing the internet up to 20 miles from the coast

Category: All-in-One outdoor unit/ 4G CAT4

Subcategory: Dual SIM / up to 20 miles

Code: IT1004PLUSEVO

Code: IT1004PLUSEVO-BK



weBBoat® 4G Plus EVO is the first and award winning COASTAL INTERNET 4G/Wi-Fi DUAL SIM integrated system to surf the web. The system ensures stable and high speed connections up to approximately 20 miles from the coast. The weBBoat® 4G Plus EVO is equipped with four 4G/3G diversity antennas, two diversity Wi-Fi antennas, and a super-fast 3G/4G/Wi-Fi router that creates a hot spot on the boat. Up to 32 different devices can be used simultaneously. The units built-in advanced switching software allows the user to save money on costly roaming and overage charges by automatically switching to Wi-Fi when available.

The weBBoat® 4G Plus is a true Plug & Play device that requires only a 10 to 30 Vdc power source and supports two Micro-SIM cards for surfing the Internet. The Dual SIM architecture allows the user to have more choices for operation (i.e. different carriers for coverage, extra data if one card runs out, etc).

Some of the weBBoat® 4G Plus EVO main features are:

- ▶ Automatic APN: Easier and Faster configuration with the automatic selection of your SIM card carrier APN.
- ▶ Using the Glomex webUI or App you can manage and configure any aspect of your onboard internet connection system. You can also read/send SMS and check the SIM credit and the cellular internet data consumption.
- ▶ Priority function: to choose which connection type is used and in which assigned priority order. Typically, the highest priority source will be the cheaper high bandwidth connections (marina Wi-Fi, then Cellular) with the lowest priority source being the more expensive satellite internet connection. With weBBoat® 4G Plus EVO you can choose also to enable only one internet connection methods, for example the marina Wi-Fi to reduce the cellular or satellite internet data consumption and costs.
- ▶ Encrypted real-time peer-to-peer connection for remote set-up & service.

code: IT1004PLUSEVO, IT1004PLUSEVO/BK (for Europe, Middle East, Africa and Asia)

code: IT1004PLUSEVO/US, T1004PLUSEVO/US/BK (for North America)

code: IT1004PLUSEVO/SA, T1004PLUSEVO/SA/BK (for South America, Australia and New Zealand)

OPTIONAL ACCESSORIES



▲ V9124 stainless steel mount.



▲ ITM001 nylon mount for cross tree

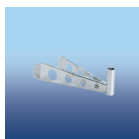

▲ IV9173TV Stainless steel masthead mount (diameter 25 mm/1)



▲ ITAP001 Access point



weBBoat® 4G Lite High Speed

4G/Wi-Fi High Speed Single SIM outdoor system to surf the web up to 15 miles from the coast

Category: All-in-One outdoor unit, 4G CAT6

Subcategory: Single SIM / 15 miles

Code: IT1104HS

Code: IT1104HS/BK



weBBoat® 4G Lite High Speed is the COMPACT ALL-IN-ONE COASTAL INTERNET 4G/Wi-Fi single SIM integrated system to surf the web at sea (up to approximately 15 miles from the coast) and in marginal signal areas on land. The system provides the perfect balance between small dimensions and great performance, ensuring stable and high speed connections. weBBoat® 4G Lite High Speed is equipped with two 4G diversity antennas, two 2.4GHz MIMO Wi-Fi antennas, and a super-fast 4G/Wi-Fi router that creates a safe hotspot on the boat.

weBBoat® 4G Lite High Speed ensures high connection speed, up to 300Mbps in DL, that allows you to surf the web, make video calls and watch streaming platform along the coast. Moreover, it has a new double power processor and the carrier aggregation function to optimize the speed of data transfers and taking advantage of all the potential offered by the net. Thanks to the weBBoat® 4G Lite High Speed systems, you can use up to 24 different devices simultaneously without any degradation to the signal or performance. The units built-in advanced switching software allows the user to save money on costly roaming and overage charges by automatically switching to Wi-Fi when available. The weBBoat® 4G Lite is a true Plug&Play devices that requires only a 10 to 30 Vdc power source and supports two Micro-SIM cards to surf the Internet.

Moreover, all functions of the unit are manageable through the iOS/Android free App, such as automatic APN, SMS management, monitoring the internet data consumption, automatic switching mode with onboard satellite internet devices/V-SAT, and an encrypted real-time peer-to-peer connection for remote set-up and service.

Some of the weBBoat® 4G Lite High Speed main features are:

- ▶ Carrier aggregation. weBBoat® 4G Lite High Speed takes advantage of the flexible bandwidth option in LTE and adds the capability to combine multiple bands of the carrier into one big channel. It can access a much bigger data pipe and therefore the achievable data rates improve significantly. Carrier aggregation is supported by improvements to the unit technologies, to make the overall spectrum usage more efficient.
- ▶ Automatic APN: Easier and Faster configuration with the automatic selection of your SIM card carrier APN.
- ▶ Using the Glomex webUI or App you can manage and configure any aspect of your onboard internet connection system. You can also read/send SMS and check the SIM credit and the cellular internet data consumption.
- ▶ Priority function: to choose which connection type is used and in which assigned priority order. Typically, the highest priority source will be the cheaper high bandwidth connections (marina Wi-Fi, then Cellular) with the lowest priority source being the more expensive satellite internet connection. With weBBoat® 4G Lite High Speed you can choose also to enable only one internet connection methods, for example the marina Wi-Fi to reduce the cellular or satellite internet data consumption and costs.
- ▶ Encrypted real-time peer-to-peer connection for remote set-up & service.

OPTIONAL ACCESSORIES



▲ ITM002 nylon mount for cross tree

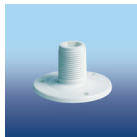

▲ V91750T nylon mount



▲ V9177 stainless steel mount

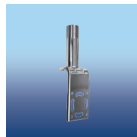

▲ V9176 electropolished stainless steel masthead L bracket

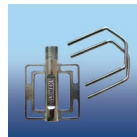

▲ V9171 electropolished stainless steel pipe mounting bracket



▲ ITAP001 Access point

weBBoat® 4G Lite EVO

Outdoor 4G/Wi-Fi High Speed compact Single SIM coastal internet system antenna for surfing the internet up to 15 miles

Category: All-in-One outdoor unit, 4G CAT4

Subcategory: Single SIM / 15 miles

Code: IT1104EVO

Code: IT1104EVO-BK



The weBBoat® 4G Lite EVO is a COMPACT COASTAL INTERNET 4G/3G/Wi-Fi SINGLE SIM integrated system to surf the web at sea (up to approximately 15 miles from the coast) and in marginal signal areas on land.

The system provides the perfect balance between small dimensions and great performance, ensuring stable and high speed connections. The weBBoat® 4G Lite EVO is equipped with two 4G/3G diversity antennas, one Wi-Fi antenna, an internal single SIM card slot, and a super-fast 4G/3G/Wi-Fi router that creates a safe hotspot on the boat. Up to 24 different devices can be used simultaneously without any degradation to the signal or performance.

The units built-in advanced switching software allows the user to save money on costly roaming and overage charges by automatically switching to Wi-Fi when available (for example the marina Wi-Fi).

The weBBoat® 4G Lite EVO is a true Plug & Play device that only a 10 to 30 Vdc power source and supports two Micro-SIM cards for surfing the Internet. Most importantly, all functions of the unit are controlled by the free App which is available for both Android and iOS devices.

Some of the weBBoat® 4G Lite EVO main features are:

- ▶ Automatic APN: Easier and Faster configuration with the automatic selection of your SIM card carrier APN.
- ▶ Using the Glomex webUI or App you can manage and configure any aspect of your onboard internet connection system. You can also read/send SMS and check the SIM credit and the cellular internet data consumption.
- ▶ Priority function: to choose which connection type is used and in which assigned priority order. Typically, the highest priority source will be the cheaper high bandwidth connections (marina Wi-Fi, then Cellular) with the lowest priority source being the more expensive satellite internet connection. With weBBoat® 4G Lite EVO you can choose also to enable only one internet connection methods, for example the marina Wi-Fi to reduce the cellular or satellite internet data consumption and costs.
- ▶ Encrypted real-time peer-to-peer connection for remote set-up & service.

code: IT1104EVO, IT1104EVO/BK (for Europe, Middle East, Africa and Asia)

code: IT1104EVO/US, IT1104EVO/US/BK (for North America)

code: IT1104EVO/SA, IT1104EVO/SA/BK (for South America, Australia and New Zealand)

OPTIONAL ACCESSORIES



▲ ITM002 nylon mount for cross tree

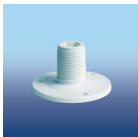

▲ V9175OT nylon mount



▲ V9177 stainless steel mount

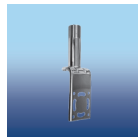

▲ V9176 electropolished stainless steel masthead L bracket

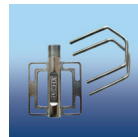

▲ V9171 electropolished stainless steel pipe mounting bracket



weBBoat® Link PRO 5G EXT

DUAL SIM 5G/4G/WI-FI COASTAL INTERNET indoor extended system to surf the web up to 20 miles

Category: Indoor unit + external antennas

Subcategory: Dual SIM / 20 miles

Code: IT1405PROEXT



weBBoat® Link PRO 5G EXT (code IT1405PROEXT) is the new Dual SIM 5G/4G/Wi-Fi Coastal kit, working worldwide, with units to be placed inside the boat + 4 high gain external 5G antennas and 4 LMR200 7m coaxial cables to surf the internet and have a secure Wi-Fi hotspot inside and outside the boat up to 20 miles from the coast. Now, you have an ultra-fast connection download speed on board: up to 2.5 Gbps. Moreover, if you sail in an area with no 5G signal coverage, the LTE CAT 16 unit allows you to have a 4G connection speed up to 1Gbps. 5G offers a connection with the same level of fibre connection, but totally wireless and therefore perfect to be used on board. There are 4 x high performance antennas, to be placed externally, and 2 x 2.4/5GHz MIMO Wi-Fi for optimizing the speed of data transfers with a huge increase on the connection speed. That means that you can either watch streaming TV channels and platforms such as Netflix or Amazon Prime offshore, or work remotely on your boat, using internet connection as like you would be on the mainland. Equipped with the new revolutionary Glomex MIoT Routerboard platform with a super-powerful processor, that highly increases the connection speed compared to other existing internet systems. Up to 32 different devices can be used simultaneously without any degradation to the signal or performance.

With the weBBoat® Link PRO 5G EXT, it is possible to use different methods of Internet connection, allowing the combination of Wi-Fi, cellular and satellite Internet (if available) in a single on-board Internet system. This allows a non-stop Internet connection both along the coast and offshore. As the boat moves away from the marina, and the Wi-Fi signal is no longer available, weBBoat® Link PRO 5G EXT maintains the internet signal via SIM and when the distance to the coast does not allow navigation via mobile SIM, the on-board satellite internet connection can be used.

Some of the weBBoat® Link PRO 5G EXT main features are:

- ▶ Completely new firmware and user interface with new features
- ▶ Carrier aggregation. The new weBBoat Link PRO 5G EXT takes advantage of the flexible bandwidth option in LTE and adds the capability to combine multiple bands of the carrier into one big channel. It can access a much bigger data pipe and therefore the achievable data rates improve significantly. Carrier aggregation is supported by improvements to the unit technologies, to make the overall spectrum usage more efficient
- ▶ Automatic APN: Easier and Faster configuration with the automatic selection of your Wi-Fi card carrier APN.
- ▶ Optimized to implement any type of IoT solution
- ▶ Using the Glomex webUI or App you can manage and configure any aspect of your onboard internet connection system. You can also read/send SMS and check the SIM credit and the cellular internet data consumption.
- ▶ Priority function: to choose which connection type is used and in which assigned priority order. Typically, the highest priority links will be the cheaper high bandwidth connections (marina Wi-Fi, then Cellular) with the lowest priority link being the more expensive satellite internet connection. With weBBoat® Link PRO 5G EXT you can choose also to enable only one internet connection methods, for example the marina Wi-Fi to reduce the cellular or satellite internet data consumption and costs.
- ▶ Encrypted real-time peer-to-peer connection for remote set-up & service.

SUPPLIED ACCESSORIES

OPTIONAL ACCESSORIES



▲ Indoor unit



▲ 4 x high gain external 5G antennas



▲ 4 x 7m (23') LMR200 pre-wired coax cables



▲ Nylon deck mount



▲ ITM001 nylon mount for cross tree



weBBoat® Link PRO 5G

DUAL SIM 5G/4G/Wi-Fi COSTAL INERNET indoor unit to surf the web up to 15 miles from the coast

Category: Indoor unit

Subcategory: Dual SIM / 15 miles

Code: IT1405PRO



weBBoat® Link PRO 5G (code IT1405PRO) is the new Worldwide* Dual SIM 5G/4G/Wi-Fi indoor unit Coastal internet system to get internet on your boat and a secure Wi-Fi hotspot inside and outside the boat using the in-built 5G and Wi-Fi antennas for fast connection up to 15 miles from the coast. The weBBoat® Link PRO 5G is a true compact Plug & Play device that requires minimal setup. Now, you have an ultra-fast connection download speed on board: up to 2.5 Gbps. Moreover, if you sail in an area with no 5G signal coverage, the LTE CAT 16 unit allows you to have a 4G connection speed up to 1Gbps. 5G offers a connection with the same level of fibre collection, but totally wireless and therefore perfect to be used on board. There are 4 x high performance 5G and 2 x 2.4/5GHz MIMO Wi-Fi antennas for optimizing the speed of data transfers with a huge increase on the connection speed. That means that you can either watch streaming TV channels and platforms such as Netflix o Amazon Prime, offshore, or work remotely from your boat, using internet connection as like you would be on the mainland.

Equipped with the new revolutionary Glomex MIoT Routerboard platform with a super-powerful processor, that highly increases the connection speed compared to other existing internet systems. Up to 32 different devices can be used simultaneously without any degradation to the signal or performance. With the weBBoat® Link PRO 5G, it is possible to use different methods of Internet connection, allowing the combination of Wi-Fi, cellular and satellite Internet (if available) in a single on-board Internet system. This allows a non-stop Internet connection both along the coast and offshore. As the boat moves away from the marina, and the Wi-Fi signal is no longer available, weBBoat® Link PRO 5G maintains the internet signal via SIM and when the distance to the coast does not allow navigation via mobile SIM, the on-board satellite internet connection can be used.

Some of the weBBoat® Link PRO 5G main features are:

- ▶ Completely new firmware and user interface with new features
- ▶ Carrier aggregation. The new weBBoat Link PRO 5G takes advantage of the flexible bandwidth option in LTE and adds the capability to combine multiple bands of the carrier into one big channel. It can access a much bigger data pipe and therefore the achievable data rates improve significantly. Carrier aggregation is supported by improvements to the unit technologies, to make the overall spectrum usage more efficient
- ▶ Optimised to implement any type of IoT solution.
- ▶ Automatic APN: Easier and Faster configuration with the automatic selection of your SIM card carrier APN.
- ▶ Using the Glomex webUI or App you can manage and configure any aspect of your onboard internet connection system. You can also read/send SMS and check the SIM credit and the cellular internet data consumption.
- ▶ Connection priority management: : to choose which connection type is used and in which assigned priority order. Typically, the highest priority links will be the cheaper high bandwidth connections (marina Wi-Fi, then Cellular) with the lowest priority link being the more expensive satellite internet connection. With weBBoat® Link PRO 5G you can choose also to enable only one internet connection methods, for example the marina Wi-Fi to reduce the cellular or satellite internet data consumption and costs.
- ▶ Encrypted real-time peer-to-peer connection for remote set-up & service.
- ▶ In-built speed-test feature.

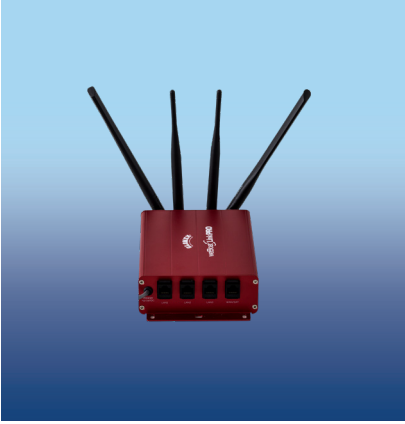

weBBoat® Link PRO

DUAL SIM 4G/WI-FI COASTAL INTERNET indoor system for surfing the internet up to 10 miles

Category: Indoor unit

Subcategory: Dual SIM / 10 miles

Code: IT1304PRO



weBBoat® Link PRO (code IT1304PRO) is Dual SIM 4G/Wi-Fi indoor unit Coastal internet system to get internet on your boat and a secure Wi-Fi hotspot inside and outside the boat using the in-built 4G and Wi-Fi antennas for fast connection up to 10 miles from the coast. The weBBoat® Link PRO is a true compact Plug & Play device that requires minimal setup.

With the weBBoat® Link PRO, it is possible to use different methods of Internet connection, allowing the combination of Wi-Fi, cellular and satellite Internet (if available) in a single on-board Internet system. This allows a non-stop Internet connection both along the coast and offshore. As the boat moves away from the marina, and the Wi-Fi signal is no longer available, weBBoat® Link PRO maintains the internet signal via SIM and when the distance to the coast does not allow navigation via mobile SIM, the on-board satellite internet connection can be used

Some of the weBBoat® Link PRO main features are:

- ▶ Automatic APN: Easier and Faster configuration with the automatic selection of your SIM card carrier APN.
- ▶ Using the Glomex webUI or App you can manage and configure any aspect of your onboard internet connection system. You can also read/send SMS and check the SIM credit and the cellular internet data consumption.
- ▶ Priority function: to choose which connection type is used and in which assigned priority order. Typically, the highest priority links will be the cheaper high bandwidth connections (marina Wi-Fi, then Cellular) with the lowest priority link being the more expensive satellite internet connection. With weBBoat® Link PRO you can choose also to enable only one internet connection methods, for example the marina Wi-Fi to reduce the cellular or satellite internet data consumption and costs.
- ▶ Encrypted real-time peer-to-peer connection for remote set-up & service.

code: IT1304PRO (for Europe, Middle East, Africa and Asia)

code: IT1304PRO/US (for North America)

code: IT1304PRO/SA (for South America, Australia and New Zealand)

weBBoat® Link PRO EXT

Dual sim 4G/Wi-Fi ocean & coastal internet extended range kit for surfing the internet up to 20 miles

Category: Indoor unit + external antennas

Subcategory: Dual SIM / 20 miles

Code: IT1304PROEXT



weBBoat® Link PRO EXT (code IT1304PROEXT) is the new Dual SIM 4G/Wi-Fi Coastal internet system kit with indoor unit + 2 x high gain external 4G antennas and 2 x 7m (23') LMR200 coax cables to get internet on your boat and a secure Wi-Fi hotspot inside and outside the boat up to 20 miles from the coast.

With the weBBoat® Link PRO EXT, it is possible to use different methods of Internet connection, allowing the combination of Wi-Fi, cellular and satellite Internet (if available) in a single on-board Internet system. This allows a non-stop Internet connection both along the coast and offshore. As the boat moves away from the marina, and the Wi-Fi signal is no longer available, weBBoat® Link PRO EXT maintains the internet signal via SIM and when the distance to the coast does not allow navigation via mobile SIM, the on-board satellite internet connection can be used.

Some of the weBBoat® Link Pro EXT main features are:

- ▶ Automatic APN: Easier and Faster configuration with the automatic selection of your SIM card carrier APN.
- ▶ Using the Glomex webUI or App you can manage and configure any aspect of your onboard internet connection system. You can also read/send SMS and check the SIM credit and the cellular internet data consumption.
- ▶ Priority function: to choose which connection type is used and in which assigned priority order. Typically, the highest priority links will be the cheaper high bandwidth connections (marina Wi-Fi, then Cellular) with the lowest priority link being the more expensive satellite internet connection. With weBBoat® Link PRO EXT you can choose also to enable only one internet connection methods, for example the marina Wi-Fi to reduce the cellular or satellite internet data consumption and costs.
- ▶ Encrypted real-time peer-to-peer connection for remote set-up & service.

code: IT1304EXTHS (for Europe, Middle East, Africa, Asia, South America, Australia and New Zealand)

code: IT1304EXTHS/US (for North America)

SUPPLIED ACCESSORIES



▲ Indoor unit



▲ 2 x high gain external 4G antennas



▲ 2 x 7m (23') LMR200 pre-wired coax cables

OPTIONAL ACCESSORIES



▲ PRM180 Electropolished AISI316 stainless steel deck mount, 1" BSP thread



weBBoat® Link High Speed

SINGLE SIM 4G/WI-FI COASTAL INTERNET indoor system for surfing the web up to 10 miles from the coast

Category: Indoor unit

Subcategory: Single SIM/ 10 miles

Code: IT1304HS



weBBoat® Link High Speed (code IT1304HS) is the new Single SIM 4G/Wi-Fi indoor unit Coastal internet system to get internet on your boat and a secure Wi-Fi hotspot inside and outside the boat using the in-built 4G and Wi-Fi antennas for fast connection up to 10 miles from the coast.

weBBoat® Link High Speed is equipped with two 4G diversity antennas, two 2.4GHz MIMO Wi-Fi antennas, and a super-fast 4G/Wi-Fi router that creates a safe hotspot on the boat and motorhome. weBBoat® Link High Speed ensures high connection speed, up to 300Mbps in DL, that allows you to surf the web, make video calls, use different streaming platform. Moreover compared to the weBBoat has a new double power processor and the carrier aggregation function for optimizing the speed of data transfers and taking advantage of all the potential offered by the net. Thanks to the weBBoat® Link High Speed systems, you can use up to 24 different devices simultaneously without any degradation to the signal or performance.

With the weBBoat® Link High Speed, multiple methods of Internet connection can be used, allowing the combination of Internet via Wi-Fi, cellular and satellite (if available), in a single on-board Internet system. This allows for a seamless Internet connection both along the coast and offshore. When the boat moves away from the marina, and the marina's Wi-Fi signal is no longer available, weBBoat® Link High Speed maintains the Internet signal via SIM, and when the distance from the coast does not allow navigation via mobile SIM, the on-board satellite Internet connection can be used.

Some of the weBBoat® Link High Speed main features are:

- ▶ Carrier aggregation. The new weBBoat Link High Speed takes advantage of the flexible bandwidth option in LTE and adds the capability to combine multiple bands of the carrier into one big channel. It can access a much bigger data pipe and therefore the achievable data rates improve significantly. Carrier aggregation is supported by improvements to the unit technologies, to make the overall spectrum usage more efficient
- ▶ Automatic APN: Easier and Faster configuration with the automatic selection of your SIM card carrier APN.
- ▶ Using the Glomex webUI or App you can manage and configure any aspect of your onboard internet connection system. You can also read/send SMS and check the SIM credit and the cellular internet data consumption.
- ▶ Priority function: to choose which connection type is used and in which assigned priority order. Typically, the highest priority links will be the cheaper high bandwidth connections (marina Wi-Fi, then Cellular) with the lowest priority link being the more expensive satellite internet connection.



Encrypted real-time peer-to-peer connection for remote set-up & service.

code: IT1304HS (for Europe, Middle East, Africa, Asia, South America, Australia and New Zealand)

code: IT1304HS/US (for North America)



weBBoat® Link High Speed EXT

SINGLE SIM 4G/WI-FI COASTAL INTERNET extended indoor system for surfing the web up to 20 miles from the coast

Category: Indoor unit + external antennas

Subcategory: Single SIM / 20 miles

Code: IT1304HSEXT



weBBoat® Link High Speed EXT (code IT1304HSEXT) is the new Single SIM 4G/Wi-Fi Coastal internet system kit with indoor unit + 2 x high gain external 4G antennas and 2 x 7m (23') LMR200 coax cables to get internet on your boat and a secure Wi-Fi hotspot inside and outside the boat up to 20 miles from the coast.

weBBoat® Link High Speed EXT is equipped with two 4G diversity antennas, two 2.4GHz MIMO Wi-Fi antennas, and a super-fast 4G/Wi-Fi router that creates a safe hotspot on the boat and motorhome. weBBoat® Link High Speed EXT ensures high connection speed, up to 300Mbps in DL, that allows you to surf the web, make video calls, use streaming platform. Moreover, it has a new double power processor and the carrier aggregation function for optimizing the speed of data transfers and taking advantage of all the potential offered by the net. Thanks to the weBBoat® Link High Speed systems, you can use up to 24 different devices simultaneously without any degradation to the signal or performance.

With the weBBoat® Link High Speed EXT, multiple methods of Internet connection can be used, allowing the combination of Internet via Wi-Fi, cellular, and satellite (if available), in a single on-board Internet system. This allows a seamless Internet connection both along the coast and offshore. When the boat moves away from the marina, and the marina's Wi-Fi signal is no longer available, weBBoat® Link High Speed EXT maintains the Internet signal via SIM, and when the distance from the coast does not allow navigation via mobile SIM, the on-board satellite Internet connection can be used.

Some of the weBBoat® Link High Speed EXT main features are:

- ▶ **Carrier aggregation.** The new weBBoat Link High Speed EXT takes advantage of the flexible bandwidth option in LTE and adds the capability to combine multiple bands of the carrier into one big channel. It can access a much bigger data pipe and therefore the achievable data rates improve significantly. Carrier aggregation is supported by improvements to the unit technologies, to make the overall spectrum usage more efficient
- ▶ **Automatic APN:** Easier and Faster configuration with the automatic selection of your SIM card carrier APN.
- ▶ **Using the Glomex webUI or App** you can manage and configure any aspect of your onboard internet connection system. You can also read/send SMS and check the SIM credit and the cellular internet data consumption.
- ▶ **Priority function:** to choose which connection type is used and in which assigned priority order. Typically, the highest priority links will be the cheaper high bandwidth connections (marina Wi-Fi, then Cellular) with the lowest priority link being the more expensive satellite internet connection.
- ▶ **Encrypted real-time peer-to-peer connection** for remote set-up & service.

code: IT1304EXTHS (for Europe, Middle East, Africa, Asia, South America, Australia and New Zealand)

code: IT1304EXTHS/US (for North America)

SUPPLIED ACCESSORIES



▲ 2 x high gain external 4G antennas



▲ 2 x high gain external 4G antennas



▲ 2 x 7m (23') LMR200 pre-wired coax cables



▲ PRM180 Electropolished AISI316 stainless steel deck mount, 1" BSP thread

OPTIONAL ACCESSORIES



weBBoat® Link

Single sim 4G/Wi-Fi ocean & coastal internet indoor unit for surfing the internet up to 10 miles

Category: Indoor unit

Subcategory: Single SIM

Code: IT1304



weBBoat® Link (code IT1304) is the Single SIM 4G/Wi-Fi indoor unit Coastal internet system to get internet on your boat and a secure Wi-Fi hotspot inside and outside the boat using the in-built 4G and Wi-Fi antennas for fast connection up to 10 miles from the coast.

With the weBBoat® Link, multiple methods of Internet connection can be used, allowing the combination of Internet via Wi-Fi, cellular, and satellite (if available), in a single on-board Internet system. This allows a seamless Internet connection both along the coast and offshore. When the boat moves away from the marina, and the marina's Wi-Fi signal is no longer available, weBBoat® Link maintains the Internet signal via SIM, and when the distance from the coast does not allow navigation via mobile SIM, the on-board satellite Internet connection can be used.

Some of the weBBoat® Link main features are:

- ▶ Automatic APN: Easier and Faster configuration with the automatic selection of your SIM card carrier APN.
- ▶ Using the Glomex webUI or App you can manage and configure any aspect of your onboard internet connection system. You can also read/send SMS and check the SIM credit and the cellular internet data consumption.
- ▶ Priority function: to choose which connection type is used and in which assigned priority order. Typically, the highest priority links will be the cheaper high bandwidth connections (marina Wi-Fi, then Cellular) with the lowest priority link being the more expensive satellite internet connection.
- ▶ Encrypted real-time peer-to-peer connection for remote set-up & service.

weBBoat® Link EXT



SINGLE SIM 4G/WI-FI COASTAL INTERNET extended indoor system for surfing the web up to 20 miles from the coast

Category: Indoor unit + external antennas

Subcategory: Single SIM / 20 miles

Code: IT1304EXT



weBBoat® Link EXT (code IT1304EXT) is the Single SIM 4G/Wi-Fi Coastal internet system kit with indoor unit + 2 x high gain external 4G antennas and 2 x 7m (23') LMR200 coax cables to get internet on your boat and a secure Wi-Fi hotspot inside and outside the boat up to 20 miles from the coast.

With the weBBoat® Link EXT, multiple methods of Internet connection can be used, allowing the combination of Internet via Wi-Fi, cellular, and satellite (if available), in a single on-board Internet system. This allows a seamless Internet connection both along the coast and offshore. When the boat moves away from the marina, and the marina's Wi-Fi signal is no longer available, weBBoat® Link EXT maintains the Internet signal via SIM, and when the distance from the coast does not allow navigation via mobile SIM, the on-board satellite Internet connection can be used.

Some of the weBBoat Link EXT main features are:

- ▶ Automatic APN: Easier and Faster configuration with the automatic selection of your SIM card carrier APN.
- ▶ Using the Glomex webUI or App you can manage and configure any aspect of your onboard internet connection system. You can also read/send SMS and check the SIM credit and the cellular internet data consumption.
- ▶ Priority function: to choose which connection type is used and in which assigned priority order. Typically, the highest priority links will be the cheaper high bandwidth connections (marina Wi-Fi, then Cellular) with the lowest priority link being the more expensive satellite internet connection.
- ▶ Encrypted real-time peer-to-peer connection for remote set-up & service.

SUPPLIED ACCESSORIES



▲ high gain external 4G antenna



▲ 2 x high gain external 4G antennas

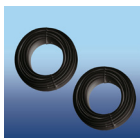

▲ 2 x 7m (23') LMR200 pre-wired coax cables

OPTIONAL ACCESSORIES



▲ PRM180 Electropolished AISI316 stainless steel deck mount, 1" BSP thread

DATA TRANSMISSION

Every day we use various technologies for data exchange among there wa see those that can be used in marine environments and their application.

Basically we can define a set of wireless technologies that allow communications over distances and increasing speeds, offer different performance and are generally used for specific purposes.

GPRS/UMTS/LITE4G/5G
DOZENS NM
HUNDREDS OF KB/S
HUNDREDS OF MB/S
DEPENDING OF THE DISTANCE

MOBILE LAN
WIFI IEE 802.11
HUNDREDS OF METERS
>10 MB/S

INTERNAL NETWORK
OF THE BOAT WITH CABLES OR
WIFI TECHNOLOGY



GPRS/UMTS/LTE/4G/5G
TEN OF NM
HUNDREDS OF MB/S

MOBILE LAN
WIFI IEE 802.11
HUNDREDS OF METERS
>10 MB/S

BLUETOOTH
>10 METERS
=1MT/S

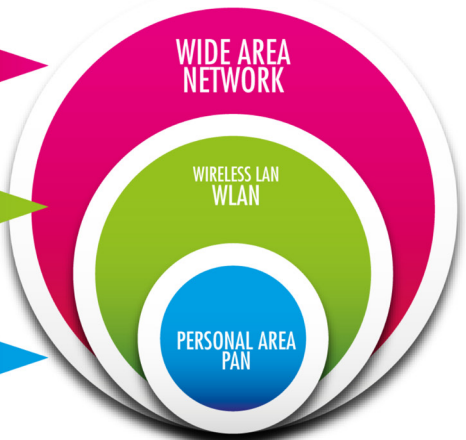

Specifically, applications determine which technology is the best for the use you intend to do as the performance is different. Often they coexist in the same network and overlap each other because their intrinsic qualities make them the best solution.

WeBBoat uses parts of these technologies to ensure an internet connection suited to sending Email, access to the WEB, VOIP, Downloads, Video Stream.

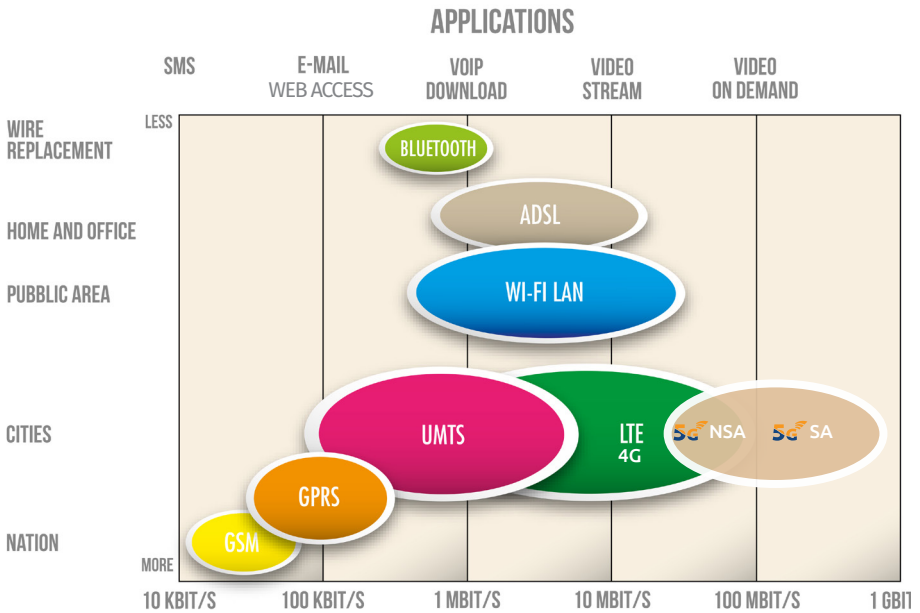

Open-sea Testing

weBoat® Plus 5G

test lab 3



- 5** 22.13 nm
Speed: 1.42 Mbps
- 6** 30.10 nm
Speed: 10.8 Mbps
- 4** 17.49 nm
Speed: 21.6 Mbps
- 3** 9.28 nm
Speed: 9.72 Mbps
- 2** 3.93 nm
Speed: 7736 Mbps
- 1** 0 nm
Speed: 69.82 Mbps

Height of the cell tower 11mt



5/13/22 9:38

Download 69.82 Mbps
 Upload 40.05 Mbps
 Latenza 61
 IPesterno 77.17.54.130
 Position 44.488246, 12.285451
 Provider Telenor

44.48824, 12.28545

1

5/13/22 10:02

Download 7736 Mbps
 Upload 15765 Mbps
 Latenza 51
 IPesterno 37,162,223,167
 Position 44.517054, 12.363074
 Provider Telenor

44.51705, 12.36307

2

5/13/22 10:55

Download 9.82 Mbps
 Upload 24.33 Mbps
 Latenza 62
 IPesterno 46.67.208.208
 Position 44.583998, 12.507024
 Provider Iliad

44.58399, 12.50702

3

5/13/22 11:42

Download 21.16 Mbps
 Upload 37.23 Mbps
 Latenza 105
 IPesterno 46.66.199.46
 Position 44.638299, 12.633354
 Provider Iliad

44.63829, 12.63335

4

5/13/22 12:33

Download 1.42 Mbps
 Upload 3.26 Mbps
 Latenza 72
 IPesterno 37.162.79.160
 Position 44.693503, 12.769528
 Provider Telenor

44.6935, 12.76952

5

5/13/22 13:19

Download 10.8 Mbps
 Upload 9.57 Mbps
 Latenza 60
 IPesterno 37.162.79.160
 Position 44.671942, 12.913822
 Provider Telenor

44.67194, 12.91382

1 di 1

Download 10.8 Mbps
 Upload 9.57 Mbps
 Latenza 60
 IPesterno 37.162.79.160
 Position 44.671942, 12.913822
 Provider Telenor

44.67194, 12.91382

6

N 44°29.418'
 E 12°16.452'
 30.1 MN 246 °M

weBoat® Plus 5G Antennas gain patterns

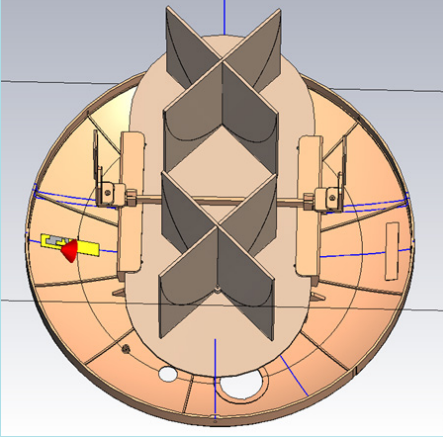

Complete system inside the Radome including the two Glomex Antennas PCB ground plane, the two mobile patch antennas, two Wi-Fi Patch antennas and the router.

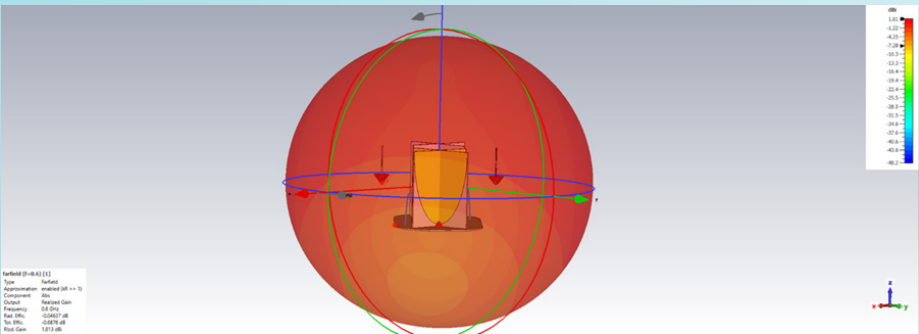

Radiation pattern of the Glomex PCB ground plane antenna at 600MHz, 5G Band.

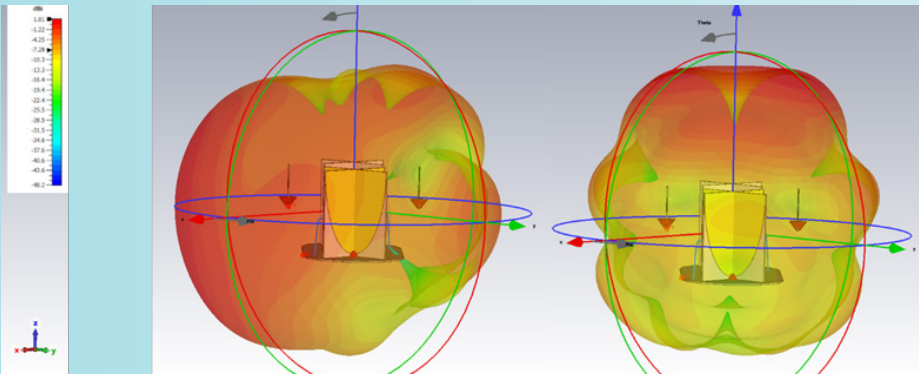

Radiation pattern of Glomex 2.2 GHz (left) and 3.3 GHz (right) antenna. The gains realized in these two configurations are 4.9 dB and 6.54 dB.

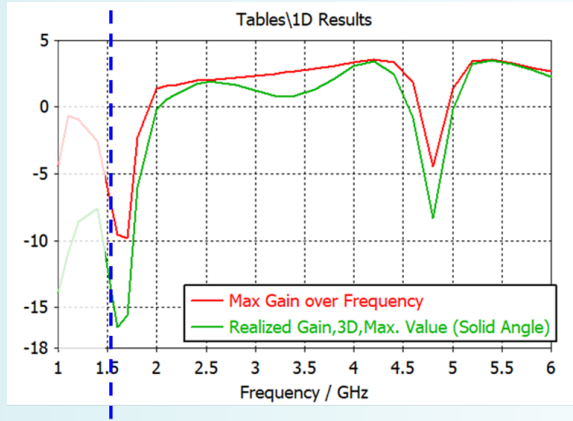

Trend of realized gain of the patch antenna.

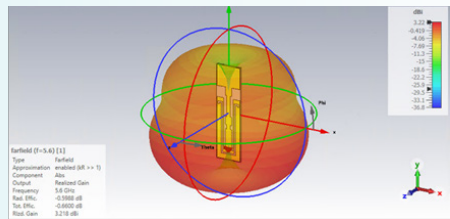
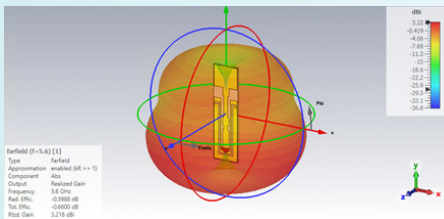

Trend of the Radiation Diagrams of the patch antenna at 2.5. GHz (left) and at 5.6 GHz (right)

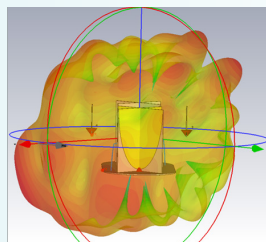
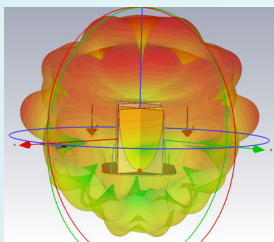

Radiation diagram of the Glomex PCB antenna (left) and Patch antenna at the frequency of 5.6GHz.

The radiation patterns are offset to cover as much of the horizontal plane as possible (keeping in mind that there are a total of 4 antennas installed). The gain is found to be 5.65 dB for the Glomex PCB antenna and 7.65 dB for the patch antenna.

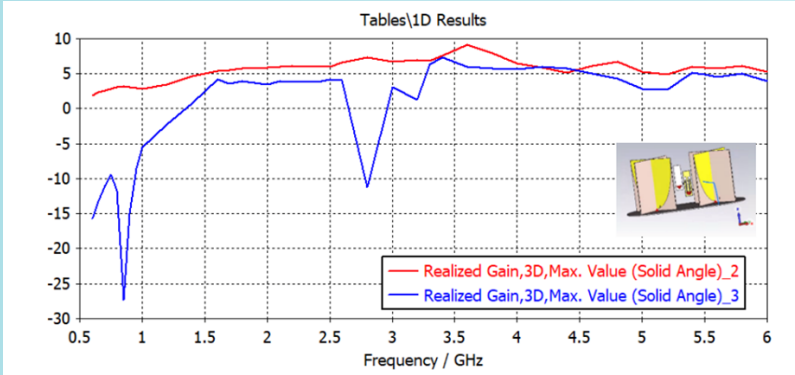

Achieved gain of the Glomex antenna (in red) and patch antenna (in blue) when integrated within the same radome.

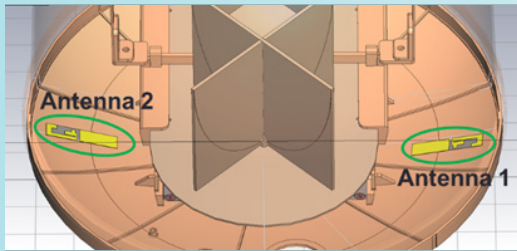

Wi-Fi patch antenna installation diagram.

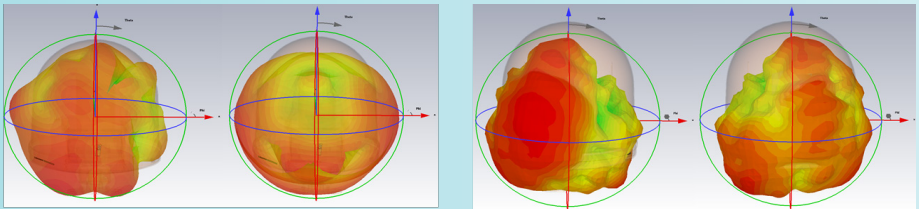

Radiation pattern emitted by Wi-Fi antennas at 2.45GHz (top) and 5GHz (bottom).



Starting at 600 MHz, virtually uniform coverage in the horizontal plane provided by the Glomex PCB antenna can be observed. These low-frequency bands are particularly important because they allow the connection to be maintained cellular even at great distances from the coast.

weBoat® range configuration

From 600 MHz to 6GHz 5G/4G diversity antennas

From 1,5 Ghz to 6GHz 5G/4G antennas

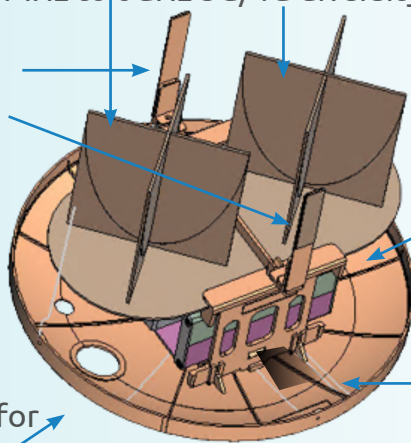

Router board MIoT Glomex

Wi-Fi antennas

External slot for 2 Micro SIM



Metal boat installation



Deck coverage

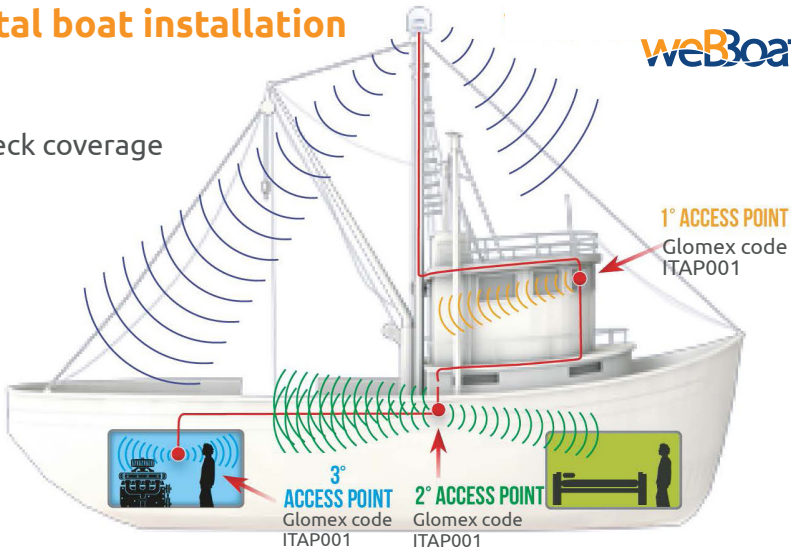

Use at maximum 4 access points

weBoat® EXTENDED SYSTEM

weBoat® COASTAL INTERNET

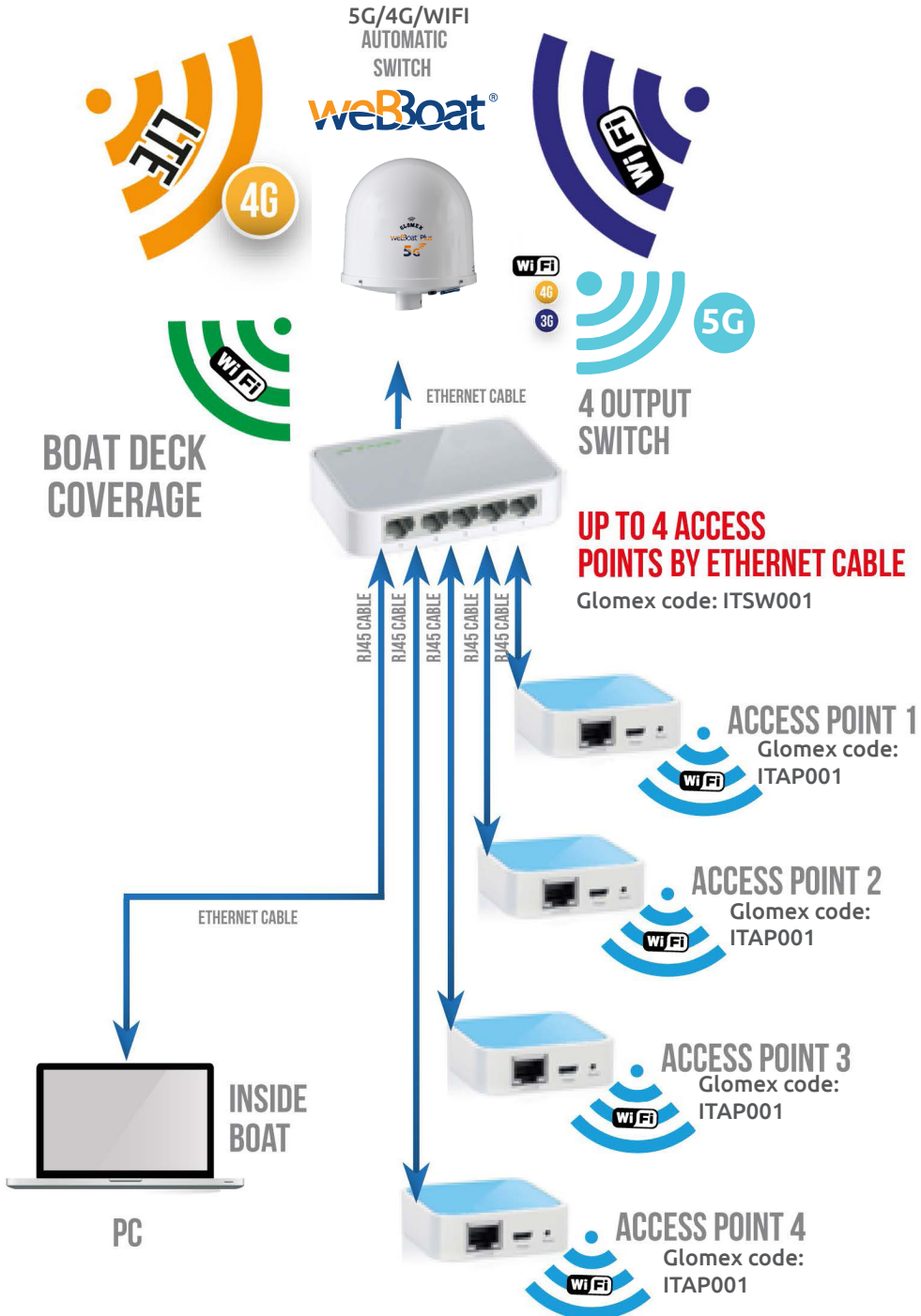

+ 20 MILES

10 MILES

ANTENNA
4G



Some words about internet

INTERNET

Internet is a worldwide network of computer networks for public access. Currently, it's the main mean of mass communication, which gives the user a wide range of potentially informative content and services.

It is a global interconnection between networks of different nature and extent, made possible by a common network protocol suite called "TCP / IP" from the name of the two main protocols, TCP and IP, which constitute the common "language" in which the computers, connected to the Internet (hosts), are interconnected and communicate each other at a higher level, regardless of the underlying hardware and software architecture and ensuring interoperability between systems and different physical subnets. The advent and diffusion of Internet and its services have represented a real technological revolution and sociological the early nineties (along with other inventions such as mobile phones and GPS) as well as one of the drivers of world economic development in 'field of Information and Communication Technology (ICT).

WI-FI NETWORKS

In the telecommunications field, Wi-Fi indicates a technology and related devices that enable end-users to connect with each other through a local network wirelessly (WLAN) based on IEEE Standard 802.11.

The local network can be connected to the Internet through a router and use all the connectivity services offered by an ISP (Internet Service Provider).

Any device or user terminal (computer, mobile phone, PDA, tablet etc.) can connect to networks of this type when integrated with the technical specifications of the protocol Wi-Fi.

The Wi-Fi network is a telecommunications network conceptually comparable to a cellular network covering a small-scale (local), with two-way radio devices such as access points (AP) in place of traditional base stations of mobile radio networks (model client-server architecture). The Wi-Fi networks are relatively cheap infrastructure and allow to realize flexible systems for the data transmission using radio frequencies, extending or connecting existing networks or creating new ones.

To increase the area of connectivity of a single access point (approximately 100 m), whose transmission power is limited by specific regulations related to electromagnetic risk (100 mW), are commonly used multiple access points (and related cells coverage) connected by wiring in the local network. For example to cover a boat metal you must use this system architecture as the metal parts block the radio waves by reducing or inhibiting the coverage of AP. The part of the radio interface

or radio Access Point-user is the access network, while the wired LAN that connects all the Access Point is the transport network. The coverage cells of AP are often partially overlapped to avoid coverage holes of the signal by creating an area

of full coverage, while the wired part is generally an Ethernet network. Each AP are "bridges" and have the task of sending the SSID that identifies the network or networks that are serving to stations radios in their wireless coverage via broadcast, while the set of stations served by the AP is called BSS (Basic Service Set). This network can be connected to the Internet network through a router taking advantage of the relative services internetworking.

System solutions without wiring are possible: connect directly into a wireless access points allowing their communication with exchange of information via radio even with a loss in spectral efficiency of the system. This kind of system solutions (without wiring) obviously entail costs and construction times significantly lower at the cost of lower connection performance.

The difference between Wi-Fi and the other cellular coverage networks resides in the communication protocols and in the operating frequency (2.4 or 5 GHz); to avoid collisions in the reception protocol is used multiple access CSMA/CA. The Wi-Fi protocols also allow to adapt the transmission speed in the wireless access is according to the distance of the mobile station transmitting by the access point, minimizing transmission losses.

To communicate with receiving stations placed in the coverage of other access points, each station must be able to register/unregister, at the time of connection, to the access point of the call (and possibly reassociate to another AP if the mobile station changes, over time, the coverage cell – handover) which, then informs to the other Access Points its presence and its IP address. In particular,

the recording of the station on the access point is made through the sending a normal data packet in which is contained the source address and the destination address.

The installation of antennas (i.e. access point) is simple. They are small antennas inside a box of few centimeters that already contain the necessary electronics and antennas for the operation.

Moreover, a Wi-Fi network can have a direct Internet access. In this case. The internet system is similar to traditional ISPs providing an access point (the PoP) to users who connect remotely via wireless connection through the so-called hotspots. The source of broadband connectivity where the hot-spot is supported can be wired (ADSL or HDSL), via phone GSM/4G/5G router, via satellite or through a Wi-Fi network. Today there are two-way satellite internet connections that allow high speed data transfer both in download and in upload. The satellite transmission, however, has high latency, the waiting time before it starts sending packets is about 1-2 seconds, a much larger compared to the few milliseconds necessary to a 4G/5G connection. Since the source of broadband it's possible to expand the network through Wi-Fi technology.

WI-FI ANTENNAS

The typologies of these antennas are basically two: omnidirectional and directives.

Omnidirectional antennas are usually used to distribute connectivity inside offices, or at least in private spaces and relatively small (this was historically the main purpose for which it was designed the protocol Wi-Fi). Or, with larger operating ranges, you can cover public areas (such as airports, shopping centers etc.).

weBBoat® uses omnidirectional antennas Wi-Fi that are best suited to a boat.

Then, Wi-Fi has evolved to cover larger areas: with the use of directional antennas it is possible to cover large distances, Wi-Fi directional antennas are generally parables, placed on pylons because in the absence of obstacles the access point's signal covers greater distances. Directional antennas, that amplify the signal of the access point are usable by more users when placed at the top. Typically this type of antenna is used outdoors in infrastructure such as networks in marine.

With an access point with omnidirectional antenna, it can be covered, with broadband, up to a distance of 100 meters (household) if there is no obstacle as the crow

flies. In the presence of walls, trees or other obstacles the signal decays to about 30 meters..

CERTIFICATIONS

A device, although complying with the standard specifications, cannot use the official Wi-Fi logo if you did not pass the certification procedures established by the Wi-Fi Alliance Consortium (Wireless Ethernet Compatibility Alliance), which tests and certifies the compatibility of wireless components with standards 802.11x (802.11 family).

CLASSES

These are various classes of Wi-Fi 2,4 and 5GHz with different performance (as specified in the IEEE 802.11 standard), the most important are:

- class b: 11 Mb/s
- class g: 54 Mb/s
- class n: 450 Mb/s
- classe ac: 3 Gb/s

POSITIVE AND NEGATIVE ASPECTS OF WI-FI NETWORKS

Comfort

Many networks provide data encryption and roaming, being able to move from the coverage of an access point to another without a drop of Internet, outside the ran-

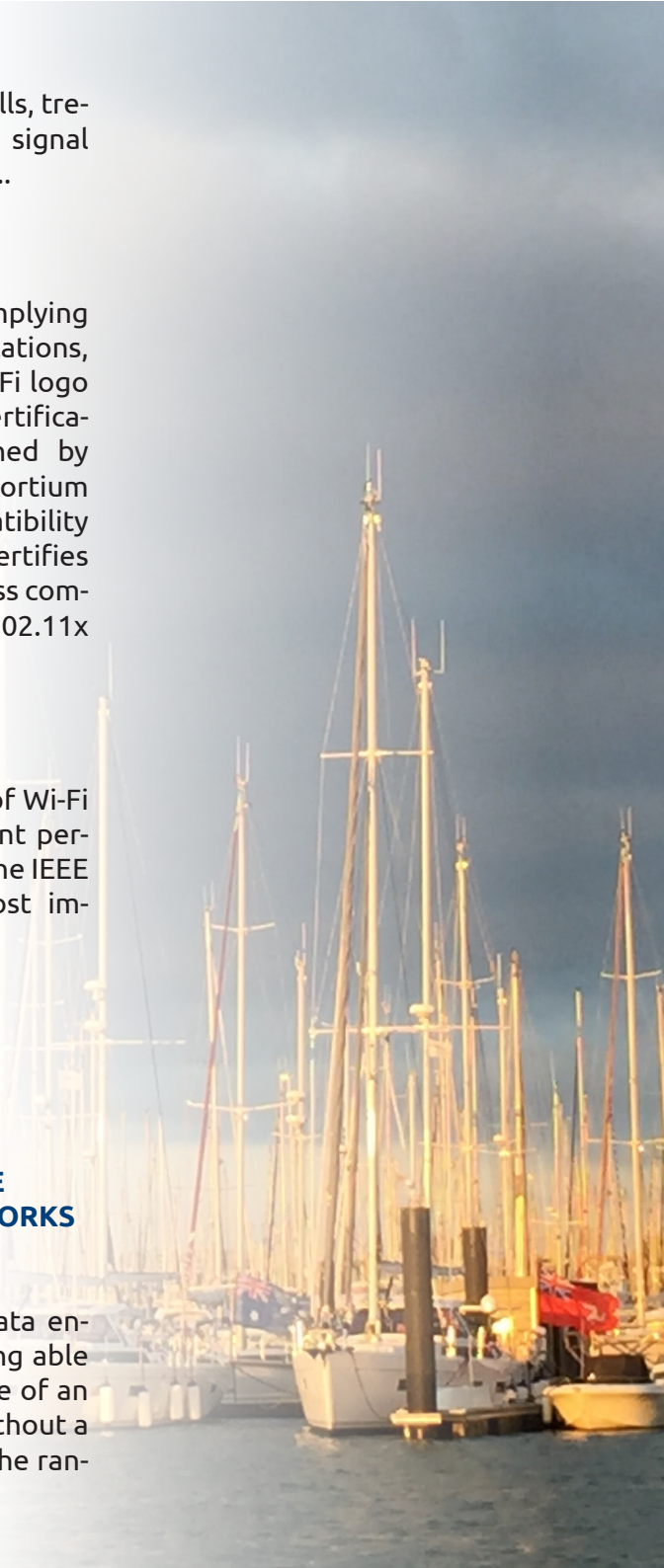

ge that defines a hot-spot. Unlike the phone, the existence of a certified standard ensures interoperability between equipment and network abroad, without the cost of cabling (being wireless technology) for faster and easier installation and subsequent expansion of the network. From this point of view the Wi-Fi, often offered free of charge, is a standard competitor to Internet access via GSM and UMTS cellular networks which have an additional cost. The presence of several producers has created considerable competition by lowering the prices of this technology.

Technical disadvantages

The latency time of the Wi-Fi cards – i.e. the time interval that elapses between the moment when an input arrives to the system and the time at which its output is available - is slightly superior to those based on a cable with a maximum latency in the order of 1-3 ms (so it's negligible, unlike the GPRS/UMTS that have latencies in the order 150 ms). A disadvantage of the Wi-Fi 802.11a/g may be the stability of the service (i.e. the quality of service - QoS) offered to the user, who due to noise on the signal can sometimes be discontinuous (for example the signal may be interfered by microwave ovens that when they

are in function disturb the operating frequency of 2.4 GHz, the problem is solved with the use of the operating frequency 5 GHz). weBBoat® 5G based on the new MIoT router board handle signals based on both 2.4GHz and 5GHz frequencies

Privacy

Most Wi-Fi networks do not provide any form of protection from unauthorized use (authentication), by sniffing the data communication (confidentiality) and on data integrity. This is due to the fact that when purchasing it, the default settings do not require the user to use a security method. Methods to avoid misuse were born together with the development of new technologies and the first system developed was the WEP, Wired Equivalent Protocol, but it is affected by security problems that make it unnecessary. You can suppress broadcast the SSID identification or restrict access to well-defined MAC addresses, but it is easily subject to bypass methods. To overcome these WEP problems, WPA and WPA2 were developed; they offer higher levels of security.

Always stay up to date!

FOLLOW US ON OUR SOCIAL CHANNELS
@GLOMEX.MARINE.ANTENNAS



DISCOVER OUR CATALOGUES



<https://www.glomex.it/product-range-e-books/?lang=en>

You are never alone on the water



test lab 3 Tested



Glomex S.p.A.

Via Faentina 165/G, 48124, Ravenna (Italy)

Tel. +39 0544 500377 • info@glomex.it

WWW.GLOMEX.IT



GLOMEX[®]

The best in marine antennas



Specifications may be changes without notice.