

## FLEXIBLE MOUNTING OPTIONS

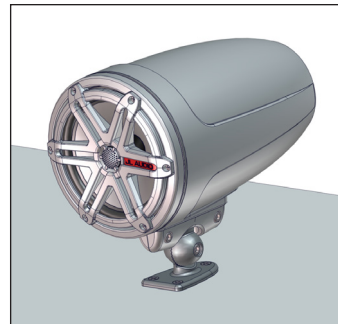

Deck Mounting



Suspended Mounting

**NOTE:** The MCPv3-DM fixture and M770-ETXv3-SG-WH Enclosed Speaker System are used in this manual for illustrative purposes only. The fixture installation steps are the same for all ETXv3 Enclosed Speaker Systems and the M-MCPv3- Deck-Mount Fixture listed on front cover.

### LIMITED WARRANTY - MARINE PRODUCTS (USA)

JL AUDIO warrants this product to be free of defects in materials and workmanship for a period of two (2) years from the original date of purchase.

This warranty is not transferable and applies only to the original purchaser from an authorized JL AUDIO dealer. Should service be necessary under this warranty for any reason due to manufacturing defect or malfunction, JL AUDIO will (at its discretion), repair or replace the defective product with new or remanufactured product at no charge. Damage caused by the following is not covered under warranty: accident, misuse, abuse, product modification or neglect, failure to follow installation instructions, unauthorized repair attempts, misrepresentations by the seller. This warranty does not cover incidental or consequential damages and does not cover the cost of removing or reinstalling the unit(s). Cosmetic damage due to accident or normal wear and tear is not covered under warranty.

Any applicable implied warranties are limited in duration to the period of the express warranty as provided herein beginning with the date of the original purchase at retail, and no warranties, whether express or implied, shall apply to this product thereafter. Some states do not allow limitations on implied warranties, therefore these exclusions may not apply to you. This warranty gives you specific legal rights, and you may also have other rights which vary from state to state.

#### For Service Information in the U.S.A. please call

**JL Audio Customer Service:** (954) 443-1100

9:00 AM – 5:30 PM (Eastern Time Zone)

#### JL Audio, Inc

10369 North Commerce Pkwy.

Miramar, FL 33025, USA

#### International Warranties:

Products purchased outside the United States of America are covered only by that country's distributor and not by JL Audio, Inc.

**JL AUDIO®** | How we play.™

[www.jlaudio.com](http://www.jlaudio.com)

JL Audio® and the JL Audio logo are registered trademarks of JL Audio, Inc. "Ahead of the Curve" and its respective logo is a trademark of JL Audio, Inc.  
©2014 JL Audio, Inc. - For more detailed information please visit us online at [www.jlaudio.com](http://www.jlaudio.com). Due to our policy of continuous product development, all specifications are subject to change without notice.



SKU# 011420

Printed in U.S.A. • 032515



Ahead of the Curve®



Installation Instructions for

**M-MCPv3-DM**

DECK MOUNTING FIXTURES  
FOR ETXv3 ENCLOSED SPEAKER SYSTEMS

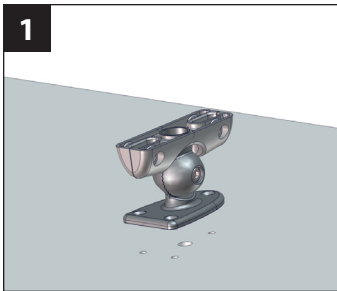

Determine the mounting location of the ETXv3 enclosure. Using the holes in the fixture base as a guide, mark the three hole locations, and carefully drill three 3/16" pilot holes and one 1/2" speaker cable hole.

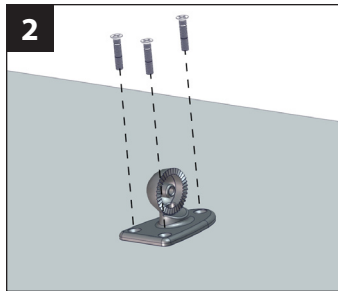

Remove the 5/16 - 18 x 1-1/4" socket head cap screw and 5/16" lock washer to separate the two fixture halves. Secure the fixture base to the mounting surface using three #14 x 1-1/4" flat head sheet metal screws (included).



Route the speaker cable exiting the enclosure through the opening in the other half of the fixture, and guide the tabs into the openings in the fixture until flush.



Apply Loctite® red thread-locking compound (included) to the two 5/16 - 18 - 1-1/8" machine screws (included), thread them into the fixture while firmly pushing the enclosure and fixture together to ensure no gap, and fully tighten.

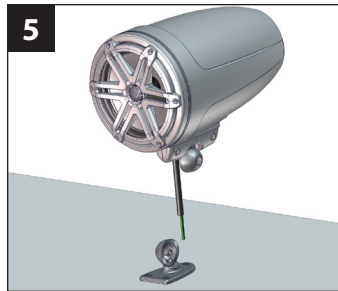

Route the speaker cable exiting the enclosure through the hole in the fixture base, and align the two fixture halves together.

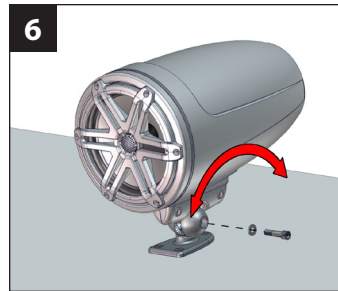

Rotate the enclosure to the desired angle, install the 5/16 - 18 x 1-1/4" socket head cap screw and 5/16" lock washer, and fully tighten.

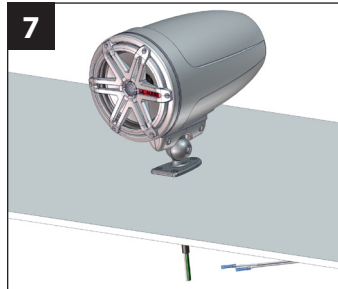

Use the supplied butt connectors to connect the red (+) and black (-) speaker cable exiting the ETXv3 enclosure to the speaker cable below the mounting surface. The green and white wires will not be used in this application.



Remove adhesive backing and install the JL Audio logo badge (*Sport Grille Models Only*).

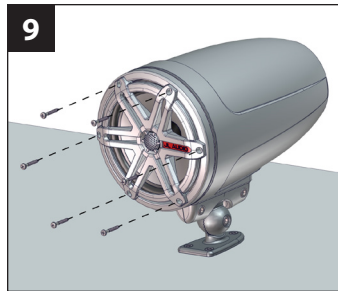

If a different speaker angle is desired, remove the speaker mounting screws and washers.

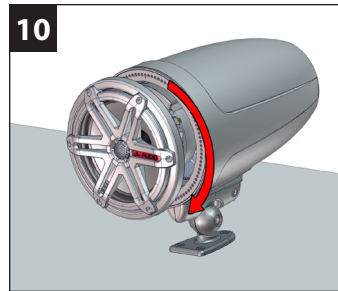

Rotate the speaker to the desired angle. Reinstall the speaker and speaker mounting screws and washers. Hand-tighten the screws in a criss-cross pattern.



For best adhesion, it is recommended to clean the inside of the aluminum cap with acetone (not included), prior to attaching it to the speaker enclosure. Apply a circular bead of silicone adhesive (included) to the inside of the aluminum logo cap, about 1/2-inch (13 mm) from the outer edge.



Align the aluminum logo cap to the desired angle of rotation, and press it onto the back of the enclosure. Apply masking tape (not included) to hold the cap in place until the silicone cures (at least 24 hours).