

Installation, use and maintenance manual

SMART 80 **Analogic 230 V ac**



Model.: SMART 80

Matriculation number: 80S230A

Year of construction: 2006

Schenker Italia

Via Delle Repubbliche Marinare, 67

80147 Naples Italy

Tel. +39 081 5593505

Fax. +39 081 5597372

E-mail: info@schenker.it

WWW.schenkerwatermakers.com

INDEX

| | |
|--|----|
| 1. MANUAL CONSULTING | 4 |
| 1.1 STRUCTURE OF THE MANUAL | 4 |
| 1.2 DESCRIPTION OF THE PICTOGRAMS | 4 |
| 2. GENERAL WARNINGS AND INFORMATION TO THE RECIPIENT | 5 |
| 2.1 IMPORTANT INFORMATION | 5 |
| 2.2 SAFETY WARNINGS | 5 |
| 2.3 START-UP | 6 |
| 2.4 WARRANTY | 6 |
| 2.5 IDENTIFICATION OF THE UNIT | 7 |
| 2.6 NORMATIVE REQUIREMENTS | 7 |
| 2.6.1 DIRECTIVES AND STANDARDS CONCERNING MACHINE SAFETY | 7 |
| 2.6.2 RESPECT FOR THE ENVIRONMENT – REQUIREMENTS FOR DEMOLITION AND DISPOSAL | 7 |
| 3. PRODUCT PRESENTATION | 9 |
| 3.1 TRANSPORT AND MATERIAL HANDLING | 9 |
| 3.2 STOCK | 10 |
| 3.3 PACKAGING | 10 |
| 3.3.1 PACKAGING CONTENTS | 10 |
| 3.4 ATTACHED DOCUMENTS | 11 |
| 3.5 TECHNICAL DATA | 11 |
| 3.6 CHARACTERISTIC OF THE PRODUCT | 12 |
| 3.7 ADVANTAGES OF THE ENERGY RECOVERY SYSTEM | 13 |
| 3.8 COMPOSITION OF THE MACHINE | 14 |
| 3.8.1 PUMP GROUP | 14 |
| 3.8.2 WATERMAKER GROUP | 15 |
| 3.8.3 ACCESSORIES | 18 |
| 4. MOUNTING AND INSTALLATION | 19 |
| 4.1 GENERAL CRITERIA | 19 |
| 4.2 COMPONENTS MOUNTINGS | 20 |
| 4.2.1 PUMP GROUP | 20 |
| 4.2.2 WATERMAKER GROUP | 20 |
| 4.2.3 ACCESSORIES | 20 |
| 4.3 INSTALLATION | 20 |
| 4.3.1 WATER INTAKES AND DISCHARGES | 20 |
| 4.3.2 SEAWATER INTAKE | 21 |
| 4.3.3 FRESH WATER INTAKE FOR WASHING | 22 |
| 4.3.4 BRINE DISCHARGE | 22 |
| 4.4 HYDRAULIC CONNECTIONS | 23 |
| 4.5 ELECTRIC CONNECTION | 26 |
| 4.5.1 REMOTE CONTROL PANEL MOUNTING | 26 |
| 4.5.2 ELECTRIC CONNECTIONS: WIRES (SMART 80 230V AC) | 27 |
| 4.5.3 ELECTRIC LAYOUT SCHEME (230V AC) | 28 |
| 5. FUNCTIONING AND USE | 30 |
| 5.1 COMMAND DESCRIPTION | 30 |
| 5.2 INTRODUCTION – BY PASS MODE | 31 |
| 5.3 FIRST START UP PROCEDURE | 31 |
| 5.3.1 MANUAL MODE ACTIVATION THROUGH THE BYPASS SELECTOR SWITCH | 32 |

| | |
|--|-----------|
| 5.3.2 PRELIMINARY CHECKS BEFORE PROCEEDING WITH THE STARTUP PROCEDURE | 32 |
| 5.3.3 START UP | 33 |
| 5.4 NORMAL OPERATING PROCEDURE | 34 |
| 5.4.1 NORMAL OPERATING PROCEDURE WITH AUTOMATIC WASHING ON (ADVISABLE PROCEDURE) | 35 |
| 5.4.2 NORMAL OPERATING PROCEDURE WITH AUTOMATIC WASHING OFF (NOT ADVISABLE PROCEDURE) .. | 35 |
| 5.5 MANUAL WASHING PROCEDURE | 36 |
| 5.6 RESET PROCEDURE | 37 |
| 6. MAINTENANCE (ROUTINE AND EXTRAORDINARY) | 39 |
| 6.1 CONTROL OF FILTER CLEANING CONDITION | 39 |
| 6.2 CHECK THE PLANT WORKING PRESSURE | 40 |
| 6.3 CHECK FOR ABSENCE OF LEAKS | 40 |
| 6.4 CHECK FOR MEMBRANES REPLACEMENT | 40 |
| 6.5 SHUTDOWN PROCEDURE | 40 |
| 6.5.1 NECESSARY EQUIPMENT | 41 |
| 6.5.2 SHUTDOWN OPERATING PROCEDURE..... | 42 |
| 6.6 ANTIFREEZE PROCEDURE (WINTERIZING PROCEDURE IN COLD CLIMATE - UNDER 5°C)..... | 45 |
| 6.7 PERIODIC MAINTENANCE..... | 46 |
| 6.7.1 MEMBRANE REPLACEMENT..... | 46 |
| 6.8 ADJUSTMENTS | 46 |
| 7. TROUBLESHOOTING..... | 47 |
| 7.1 FAILURE CHART | 47 |
| 7.2 ELECTRONIC ISSUES AND THEIR SOLUTION..... | 48 |
| 8. SUGGESTED SPARE PARTS..... | 49 |
| 8.1 SHORT TERM CRUISING..... | 49 |
| 8.2 LONG TERM CRUISING | 49 |
| 8.3 ERS SPARE PARTS | 50 |
| 8.4 ADDITIONAL SPARES | 51 |

1. MANUAL CONSULTING

1.1 Structure of the manual

The manual is divided into chapters, which gather all the information necessary to use the system without any risk.

Within each chapter there is a subdivision in paragraphs to focus on essential points; each paragraph can be pointed out with a subtitle and a description.

At the top of each page the heading section is reported in order to remind the reader the field of the page.

Within the chapter, for example chapter 1, we will have:

| | |
|---------|-------------------|
| 1 | Chapter title |
| 1.1 | Paragraph title |
| 1.1.1 | Subtitle |
| 1.1.1.1 | Further subtitles |

The numbering of the pages, figures and tables, is reset to each chapter; therefore, we will find the prefix indicating the chapter and the page number, figure or table in progressive that starts from number 1 at the beginning of each chapter.

1.2 Description of the pictograms

The following symbols will be used in the manual to highlight particularly important indications and warnings:



ATTENTION:

This symbol indicates accident prevention regulations for the operator and / or for any exposed persons.



CAUTION:

This symbol indicates that there is the possibility of damaging the system and / or its components.



NOTE:

This symbol indicates useful information.

2. GENERAL WARNINGS AND INFORMATION TO THE RECIPIENT

2.1 Important information

To safeguard the operator's safety and to avoid possible damage to the machine, before carrying out any operation on the machine, it is essential to read carefully all the instructions manual.

This manual must be complete and legible in its entirety, every operator involved in the use of the machine, or responsible for maintenance or adjustment operations, must know its location and must have the possibility to consult it at any time.

All rights of reproduction of this manual are reserved to SCHENKER ITALIA. This manual cannot be transferred to third parties without the written authorization of SCHENKER ITALIA.

The text cannot be used in other printed matter without the written permission of SCHENKER ITALIA.

The descriptions and illustrations provided in this publication are not binding.

SCHENKER ITALIA reserves the right to make any modifications it deems appropriate.

© SCHENKER ITALIA

THIS MANUAL IS PROPERTY OF SCHENKER ITALIA, ANY REPRODUCTION, EVEN PARTIAL, IS PROHIBITED.

This manual was drafted according to the requirements of the 2006/42 / EC Machinery Directive.

2.2 Safety warnings

- Wear protective equipment suitable for service operation.
- Clothing must be tight to the body, and resistant to the products used for cleaning.
- Do not remove safety devices or accident prevention protections.
- Check if the plant is correctly installed eventually contacting a Schenker service point.
- Verify that the electric and hydraulic connections are in keeping with the indicated specifications.
- The water produced by a Schenker plant, starting from picking clean seawater, is potentially potable, but the drinkable cannot be guaranteed because a bacterium may be present in some points of the plant, especially in case of non-observance of shutdown and cleaning procedures. So, avoid drinking the water produced by the plant if a sterilizer system has not been installed.
- Avoid using the plant if the sea water is polluted.
- Children and inexperienced people shall not touch or operate the plant.
- Check periodically that no leakage is present. Avoid installing the plant where an eventual leakage may cause damages and jeopardize the safety.
- Unqualified and non-Schenker personnel shall not perform any maintenance work.



ATTENTION

Any technical changes or operating conditions indicated that affect the correct operation or safety of the machine must only be carried out by the manufacturer's technical staff or by technicians formally authorized by the manufacturer. Otherwise, SCHENKER ITALIA declines any responsibility for changes or damages that may result from it.

2.3 Start-Up

The system SMART 80 test and validation takes place at the end of the assembly at Schenker Italia production site.

2.4 Warranty

The equipment and the relevant accessories are guaranteed 12 months from delivery. The guarantee does not include consumable items (filters, carbon filters, membranes, etc.). The "ERS" pressure amplification device is guaranteed 36 months, provided that the annual maintenance is performed at a Schenker service point.

The guarantee covers faults, defect of materials and parts. It is limited to the replacement or repair of faulty parts. The expense for the disconnecting and reinstalling on the vessel and transport of the equipment from or to our Service Point, or our factory will be at the customer's own expense.

The under guarantee delivered parts transport, will be at customer's own risk.

In case of repairs under guarantee performed by our technicians on the customer vessel, the faulty parts replacement cost will be at Schenker's expense, while manpower and travel expenses will be charged to the customer. The guarantee does not include faults caused by negligence in operating, maintenance and installation of the device (if not carried out by an authorized Schenker Service point).

Dismantling by non-authorized personnel will render void all guarantees. Schenker Italia cannot be held liable for any direct or indirect damage caused by the malfunctioning equipment, limiting its responsibility to the repair and replacement of faulty parts.



ATTENTION

SCHENKER ITALIA declines any responsibility for improper use of the machine, for damages caused as a result of operations not covered by this manual or unreasonable use.

2.5 Identification of the unit

All the watermakers manufactured by Schenker Italia can be identified through a serial number printed on a label which is pasted upon the aluminum frame near the manometer. The same serial number is also recorded on the central black block of the energy recovery system (ERS).



Serial number
Fig. 2-1

2.6 Normative requirements

2.6.1 Directives and standards concerning machine safety

- Machinery Directive 2006/42 / EC, in force since December 29, 2009;
- Low Voltage Directive 73/23 / EEC and subsequent amendments and additions: 93/68 / CEE implemented by the Law of 18 October 1997 n. 791.
- Electromagnetic Compatibility Directive 89/336 / EEC and subsequent amendments and additions: 93/31 / CEE implemented with D.L. December 4, 1992 n. 476.
- Standards UNI EN 292/1 and 292/2 (safety of machinery);

2.6.2 Respect for the environment – requirements for demolition and disposal



ATTENTION

Evacuate and dispose of materials, as result of the demolition of the machine, must be performed in accordance with the regulations in force, for the safeguard and protection of the environment.

With regard to demolition and disposal, it should be noted that the materials of which the machine is made of are not of a dangerous nature and consist essentially of:

- Stainless Steel;
- Aluminium;
- Plastic;
- Carbon fibre;
- Motors, cables and consumable electrical materials;
- Rubber and polyurethane seals;

After dismantling the machine, the various materials must be segregated according to the regulations of the country in which the machine has been removed.

The machine does not contain dangerous components or substances that require special removal procedures.



ATTENTION

Different legislations are in force in the different countries, therefore the prescriptions imposed by the laws and by the agencies designated by the Countries must be observed.

3. PRODUCT PRESENTATION



ATTENTION

Be sure to follow general safety instructions.

- Wear protective equipment suitable for the transport and handling operations.
- Lift the machines with equipment appropriate to the weight and size of the box, taking the utmost care and following carefully the instructions on the present use and maintenance manual (attachment points for loading devices, etc.).
- Make sure that the lifting equipment used is in good condition and correctly maintained.
- Do not stand or pass under the groups to be moved during lifting or transport operation.

3.1 Transport and material handling

The watermaker unit is transported in a carton box. In the following table dimension and weight are indicated.



MATERIALS HANDLING
fig. 3-1

| Model | L cm. | W cm. | H cm. | Weight Kg. |
|----------|-------|-------|-------|------------|
| Manual | 146 | 46 | 48 | 53 |
| Electron | 146 | 46 | 48 | 53 |

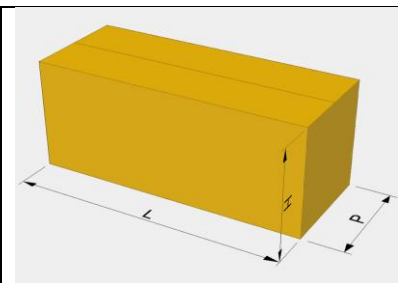

Packaging dimensions and weight
tab.3-1

3.2 Stock



ATTENTION

To avoid undesirable damages to the system be aware to stock the unit in a dry place with temperature between 5 and 40 °C. Coldest temperature could led to a freeze of the fluid inside the system with the consequence of a permanent fault of the system.

3.3 Packaging

3.3.1 Packaging contents



PACKAGING
FIG. 3-2

| SMART 80 | |
|--|--|
| Watermaker | Pump group |
| Active carbon filter with electrovalve | White filter key |
| Net filter | Non-return valve with Tee fitting |
| Remote panel with electric box | 10 mt extension cable for remote panel |
| Intallation kit | Small metal goods |
| 6x8 hose for production | Pipe fittings |

3.4 Attached documents

The packaging contains the technical documentation (use and maintenance manual, electric and hydraulic scheme, warnings and instructions).



ATTENTION

- **Lift the system only** using the aluminium structure and not through the Inox SS fittings.
- Read carefully the use and maintenance manual before installing the system.
- Use only recommended material for the installation (especially pipes, fittings and seals) in accordance with the present manual.
- Do not stock the unit under temperature of 5°.



DOCUMENTS INCLUDED IN THE PACKAGING
FIG. 3-3

3.5 Technical data



NOTE:

The following technical data refers to the watermaker SMART 80 230V Analog version

WATERMAKER GROUP

Dimensions

| | |
|---------|--------|
| Length: | 120 cm |
| Width: | 28 cm |
| Height: | 26 cm |
| Weight: | 24 Kg |

Hydraulic Connection

| | |
|-----------------|---|
| Seawater inlet: | 3/4" fitting, 16mm internal diameter reinforced hose. |
| Exhaust: | 1/2" fitting, 16mm internal diameter reinforced hose. |
| Fresh water: | 1/4" fitting, 6x8mm hose. |

PUMP GROUP

Dimensions

| | |
|---------|-------|
| Length: | 37 cm |
| Width: | 15 cm |
| Height: | 23 cm |
| Weight: | 11 Kg |

Hydraulic Connection

Water inlet: 3/4" fitting, 16mm internal diameter reinforced hose.
Water outlet: 3/4" fitting, 16mm internal diameter reinforced hose.

Feed pump type: Rotary vane pump

Motor type: 4 poles 220 VAC monophase IP 55 0,55 Kw

Filters: n. 1 Cartridge filter 5 microns 2.32" x 9 3/4"
n. 1 Active carbon filter 2.32" x 9 3/4"

Motor power supply: 230 V AC monophase (80S230 version)

Computer power supply: 12-24 VDC +/- 15

Average electric consumption: 380 Watt/h average

Peak electric consumption: 500 Watt

Nominal fresh water production: 80 Lit/h +/- 20% @ seawater 25 °C salinity 35.000 ppm

Fresh water quality: Under 500 ppm TDS average

CEE conformity: In compliance with directives 89/392 CEE sect.1 (general safety machines requirements), 89/336 CEE (electromagnetic compatibility), 73/23 CEE (electric safety requirements)

3.6 Characteristic of the product

The machine uses sea water to produce fresh water.

The water produced by the Schenker plant, starting from clean sea water, is potentially drinkable. The requisite of potable water cannot be guaranteed, however, because in some parts of the system there may be a bacterial charge, especially in the event of non-observance of the cleaning and storage procedures. Therefore, it is suggested to avoid drinking the fresh water produced by the plant, if a UV sterilizer is not installed.

**ATTENTION**

Do not drink fresh water produced by the watermaker if a UV sterilizer system is not installed.

3.7 Advantages of the Energy recovery system

Introduction

Thank you for choosing a Schenker Watermaker.

As all the equipment, the knowledge of operating and maintenance procedures allows to use the system in the best way, and to guarantee a perfect functioning throughout the years. We invite you to read carefully this manual and to keep it for a quick reference.

Functioning principles

The Schenker watermakers, as alternative to the high-pressure pumps of traditional systems, utilizes the ENERGY RECOVERY SYSTEM patented device, which amplifies the pressure of common low-pressure pumps, and recoup all the hydraulic energy back from the membranes, allowing an high energy efficiency. The lack of high-pressure pumps makes the system silent and vibrations free, and enormously simplify the use because no adjustment is necessary for its operating.

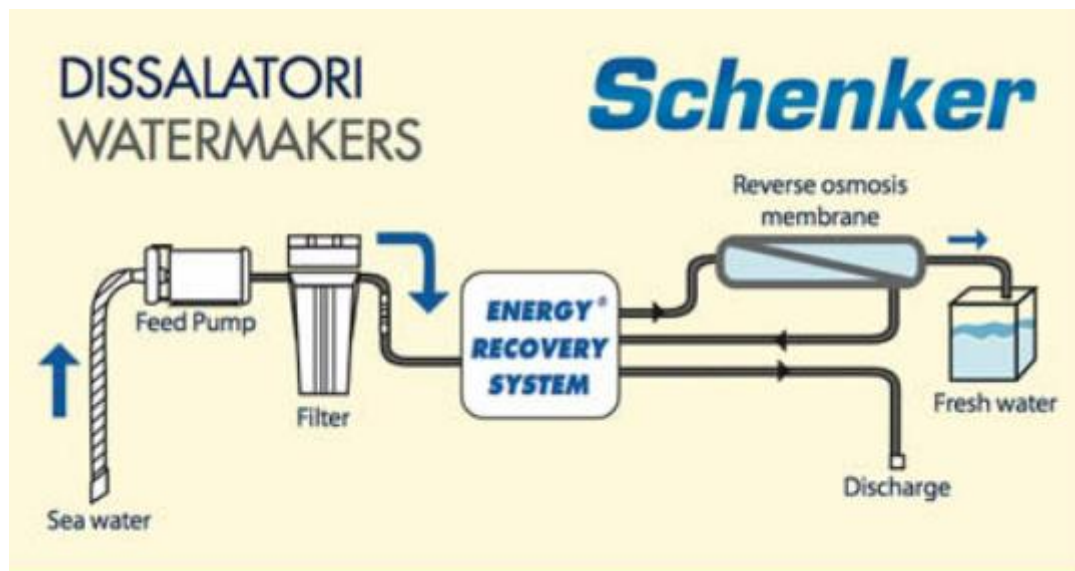

FUNCTIONING SCHEME
FIG. 3-4

3.8 Composition of the machine

The machine is composed by the following parts:

1. PUMP GROUP

2. WATERMAKER GROUP

3.8.1 Pump group

This pump has the duty of picking the sea water up and send it to the watermaker group, through the pre filter. The pump group is composed by the following components:

- 5 micron cartridge filter
- Rotary vane pump
- High pressure switch
- Pump box
- Pulsation dampener

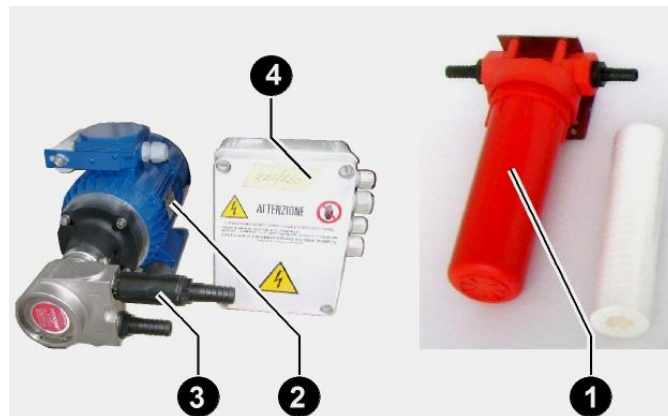

PUMP GROUP AND FILTER 230 V AC
FIG. 3-5

- | | |
|-----------------------------|------------------------|
| ① 5 micron cartridge filter | ③ High pressure switch |
| ② Pump head with AC motor | ④ Pump box with relays |

3.8.2 Watermaker group



WATERMAKER GROUP
FIG. 3-6

- ❶ Manometer
- ❷ Pulsation dampener
- ❸ Reverse osmosis membranes
- ❹ Fresh water production (grey plastic fitting)
- ❺ Depressurization valve

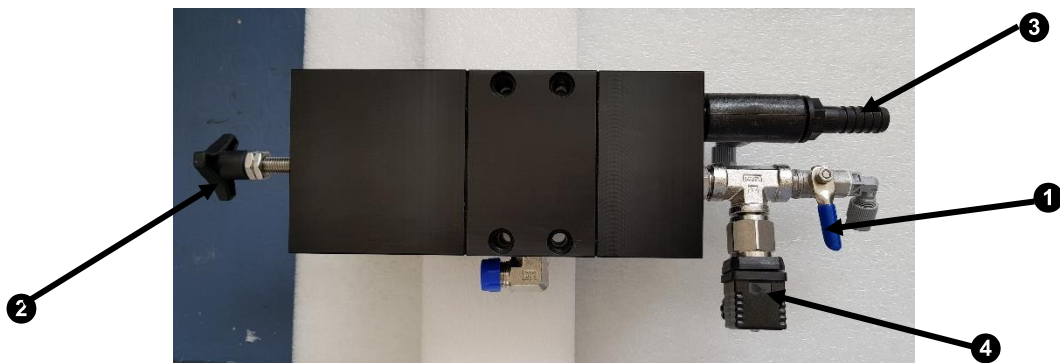

WATERMAKER GROUP (TOP VALVE VIEW)
FIG. 3-7

- ❶ Reset valve
- ❷ Positioner knob
- ❸ Concentrate water discharge
- ❹ Signal pressure switch



CONCENTRATE OUTLET (OUT) AND SEAWATER INLET (IN)
FIG. 3-8

The watermaker group is composed by the following components:

- Reverse osmosis membranes
- Energy Recovery System
- Manometer
- Flowmeter
- Depressurization valve
- Positioner
- Reset valve
- Probe (pressure switch)
- Electric box

Reverse osmosis membranes, are installed inside the glass fibre high-pressure housing. Membranes are n.2 x SW2540 type. Their purpose is to separate the intake high-pressure seawater in two flows: one for the salt-water drain and one for the fresh water production.

Energy Recovery System It is the black, carbon fibre unit. It has the function to amplify the pressure supplied by the pumps and to recoup the hydraulic energy back from the membranes. The ERS device makes periodic cycling by a hydraulically controlled automatic valve. The cycles are noticeable through a "beat" issued periodically by the watermaker unit. The unit is based on cylinders and a central body containing the hydraulic valve necessary for the system functioning.

Manometers. It is located on the front panel of the watermaker, and it measures the working pressure of the watermaker.

Pulsation dampener is a black nylon cylinder, installed in the watermaker. Its function is to reduce and stabilize the pressure peaks during the watermaker functioning. The device has to be pre-charged with air through the specific valve. The air pressure precharge is about 5 Bar. The pressure dimmer is charged in factory at the right pressure.

Depressurization valve. It is used for the air bleeding of the unit. It is recognizable by a blue lever and it is located on the right fitting of the second membrane. Its function is to depressurize the system and to allow the bleeding of air. The valve must be closed during normal working conditions (vertical position), and it is opened during the air bleeding operations (horizontal position).

Positioner. It is a stainless steel threaded arm, with a black knob, located on the right side of the watermaker. Its function is to reset the unit in case of hydraulic block.

Reset valve. It is installed on the watermaker on the top valve of the ERS and it is recognizable by the little blue plastic lever. The valve must be closed during normal functioning (lever perpendicular to the valve). Such

valve has the function to allow the reset of the ERS in case of a system block. It must be opened before acting on the valve positioner.

High pressure switch. It is hydraulically connected with the pump group. It stops the system if the pump pressure exceeds 13 bar. In this case a high-pressure alarm is activated on the control panel.

Probe (pressure switch). It is a device, hydraulically connected to the left side on the main valve of the Energy Recovery System. Its function is check that the cycling of the machine is correct. It is set at 1,3 bar.

Electric box. It contains all the electric and electronic devices necessary for the functioning of the system and the protection of the components.

It is connected to a remote control panel that allow to control the whole function of the watermaker.

3.8.3 Accessories

The main accessories of the watermaker are the followings:

- Active carbon filter
- Electrovalve
- Non-return valve
- Net filter (strainer)

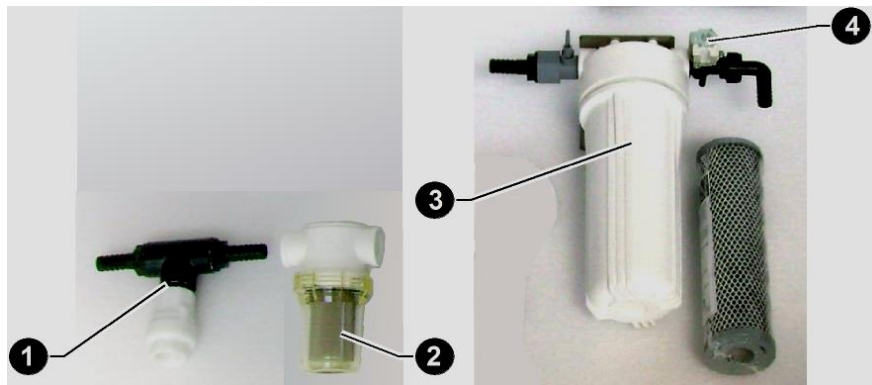

ACCESSORIES
FIG. 3-9

- ❶ Non-return valve
- ❷ Net filter (strainer)

- ❸ Active carbon filter
- ❹ Elettrovalve

Active carbon filter. This filter is connected between the fresh water pressurized system of the boat and the electro valve on the filter holder. On the filter inlet is positioned a manual valve that allows to replace the cartridge without depressurize the fresh water system of the boat.

Electrovalve. It has the function of switching from seawater intake to fresh water tank when washing the watermaker.

Non-return valve. It avoids the emptying of the inlet pipes. It must be installed horizontally. It avoids also the leak of fresh water from the seacock while washing procedure.

Net filter: The machine is equipped with a strainer to protect the pump from macro sediments. It is placed between the seacock and pre-pump.

4. MOUNTING AND INSTALLATION

4.1 General criteria

Before starting with the installation, it is important to carefully plan all the activities, by evaluating all the possible solution to be adopted. The main points to focus on are the following:

- Individuate the seawater inlet
- Positioning of the main units (pump group, watermaker group, active carbon filter).
- Positioning of the magnetothermic switch.
- Passage of the pipes and electric cables.



CAUTION

For a correct installation of the watermaker, in order to avoid issues along the different ways of operating condition, please follow carefully the general instruction below:

- *Consider to install the through-hull fitting in a central and deep position, in the way that no air could be aspirated.*
- *The non-return valve has to be installed under the seawater level and as close as possible to the through-hull fitting, in vertical position.*
- *The pump must be installed as low as possible respect to the seawater level and as close as possible to the seawater intake (through-hull fitting).*
- *The watermaker unit must be horizontally positioned, and arranged on an adequate support which is able to sustain the weight (about 50 Kg).*
- *Provide to leave a space of about 20cm on the left side of the watermaker unit in order to allow the passage of inlet and outlet (discharge) pipes.*



CAUTION

The pump group must be installed in a ventilated place, in order to facilitate the cooling. In addition to this, a place not exposed to condensation and dripping should be adopted.



ATTENTION

The external surface of motor and pump can reach high temperature; therefore, it is recommended to avoid any contact with inflammable liquids and materials.



NOTE

Once individuate the correct installation solution, it is recommended to first make a schematic draft of the hydraulic and electric connection, and attach them to the present manual for future needs as first reference.

4.2 Components mountings

4.2.1 Pump group

The rotary vane pump is a limited self-priming type, so it may be installed relatively above the seawater level. Anyway, it is suggested to install the pump group as low as possible respect to the seawater level and as close as possible to the water inlet; furthermore, the pump cannot run dry. Therefore, it is very important avoiding to start the system if the intake valve is closed or if inlet filters are clogged.

The pump group should be installed in an adequately ventilated room, with the purpose to facilitate the cooling of the motor, and not subject to condensates or drippings. **The max permitted room temperature must not exceed 45°C.**

Avoid the contact or the proximity with inflammable material or liquid, since the motor surfaces can reach elevated temperatures. Avoid locating the pump wherever a possible loss of water can involve damages or jeopardize its safety. The pump must be installed on a base sufficiently horizontal, suitable to sustain the weight of the group. The pump is normally fixed on the support structure by passing bolts.

4.2.2 Watermaker group

Concerning the watermaker unit installation there are not height limits respect to the seawater level. Anyway, it should be installed above both pumps.

Avoid to install the system wherever any possible leak may cause damages to the boat or jeopardize its safety, since possible leaks due to accidental causes (pipe bursting, hose clamp loosening, equipment failure, etc.) may cause water losses.

The hydraulic intake and outlet connections are positioned on the left of the unit. Therefore, it is necessary to foresee a minimum distance of 20 cm. to allow the pipes laying. The watermaker unit must be installed on a base sufficiently horizontal, suitable to sustain the weight of the group. **The max allowed room temperature must not exceed 40°C.** It is advisable to install the unit in such position to make the instrumentation easily visible, and make the valves (located on the right of the unit) easily accessible. The watermaker is normally fixed on the support structure by passing bolts.

4.2.3 Accessories

The non-return valve has to be installed vertically as close as possible to the seawater intake, following the direction of the arrow.

The active carbon filter (and the attached electrovalve) has to be placed next to the pump group, if possible, on a vertical side easily accessible.

4.3 Installation

4.3.1 Water intakes and discharges

For a correct installation of the watermaker it is necessary to arrange the following water intake and discharge out of the board:

- Seawater intake.
- Fresh water intake for washing.
- Brine discharge.

4.3.2 Seawater intake

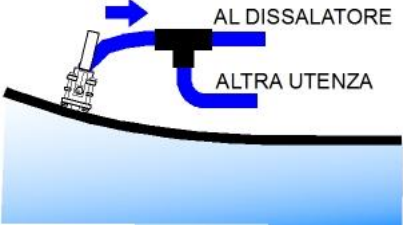
| | | |
|---|---|--|
| <p>Seacock with through-hull fitting</p> | <p>It is ideal a specific sea water intake, size 3/4" minimum in a central position, well under the water surface even when the vessel is well heeled over. The skin fitting is recommended. It must be oriented to the bow of the boat. In case of high speed vessel (over 15 knot) it is advised to make some holes on the backside of the shape, in order to reduce dynamic prevalence during navigation.</p> | <p>Size 3/4"</p>  |
| <p>Pre-existing seacock adapting (alternatively)</p> | <p>As alternative, it is possible Tee into a pre-existent water inlet as long as the following conditions are met:</p> <ul style="list-style-type: none"> • 3/4" minimum size; • No air can be introduced into the system from other use ie: salt water taps in galley; • Must always be under the water surface even when the vessel is well heeled over. • Must be far from WC discharge. <p>CAUTION Do not use the pre-existing water inlet of the cooling system dedicated to the motor.</p> | <p>Size 3/4"</p>  |



INSTALLATION NOTES

- Allow a minimum 3/4" on-off ball valve on the water intake.
- The hose connections, especially if under the seawater level, must be secured with double hose clamps.
- An easily inspected mesh type filter will be required close to the water intake. The filter has to be of 50 microns. It is possible to use filters from existing outlets.
- The seawater intake must be at least 3/4" size.
- Downstream the seawater intake must be installed a strainer filter (not included) and a non-return valve. The water flow inhaled by the watermaker is about 6 lit/min.
- The strainer has to be dimensioned for a water flow of about 6 lit/min.

| Net Filter | | |
|---|--|--|
| <p>Strainer on existing hull (alternatively)</p> | <p>In case of seawater intake with pre-existing net filter, it is possible to use it as long as the following conditions are met:</p> <ul style="list-style-type: none"> • Flow rate capacity of the filter is adequate to the whole intakes it serves. | <p>Filtration grade of the strainer is 50 mesh.</p> |



INSTALLATION NOTES

The filter has to be connected next to the through-hull fittings, and must be easily accessible for inspection.

4.3.3 Fresh water intake for washing

| | | |
|---------------------------------------|--|--|
| Fresh water intake for washing | Tee in downstream of the vessel's fresh water pressure system. The following conditions must be respected: <ul style="list-style-type: none"> • The flow of the existing fresh water pump must be min 18 lit/min. • Flushing must always be performed with the pressure water system ON. | Pressurized tank: Min. flow rate must be 18-20 lit/min. at 2,5 bar. |
|---------------------------------------|--|--|



CAUTION

Pressurized tank: Min. flow rate must be 18-20 lit/min. at 2,5 bar.

4.3.4 Brine discharge

| | | |
|--|---|------------------------|
| Salt water discharge | The salt-water drain shall be ½" minimum size and it has to be preferably above the seawater level. | Minimum size ½" |
| Pre-existing salt water discharge (alternatively) | It is possible to use offtakes from existing apparatuses, provided that: <ul style="list-style-type: none"> • It is not the engine cooling water drain or apparatuses that drain out water with elevated pressure. | |



INSTALLATION NOTES

If the discharge is upon the seawater level, it is recommended to provide a valve along the pipe.



CAUTION

Do not run the system when the discharge valve is closed.

4.4 Hydraulic connections

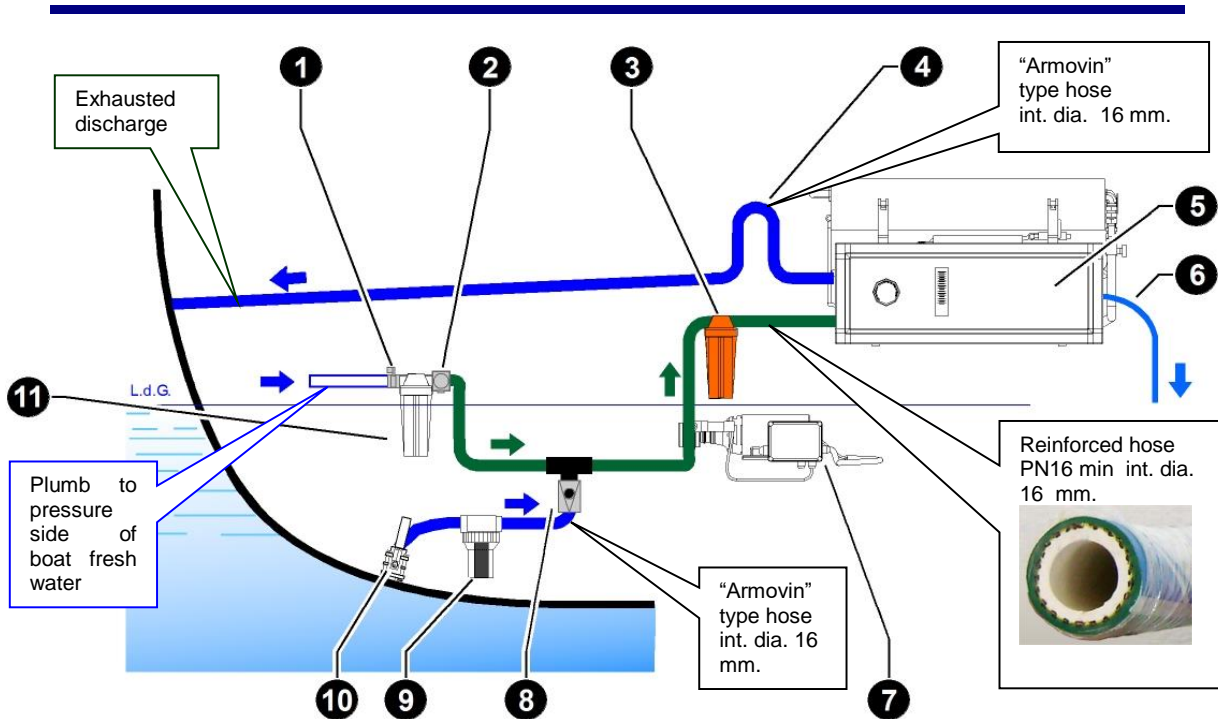

HYDRAULIC CONNECTION AND PIPES
FIG. 4-1

- | | |
|---------------------------------|------------------------|
| ① Pressurized fresh water valve | ⑦ Pump group |
| ② Electrovalve | ⑧ Non return valve |
| ③ 5 micron filter | ⑨ Net filter |
| ④ Swan neck upward - Discharge | ⑩ Water inlet |
| ⑤ Watermaker | ⑪ Active carbon filter |
| ⑥ Fresh water outlet | |

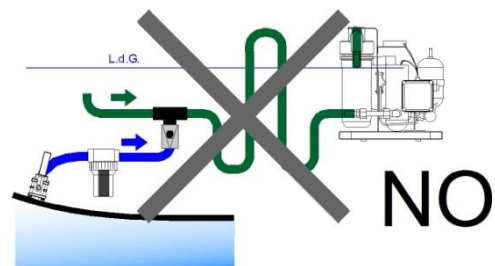
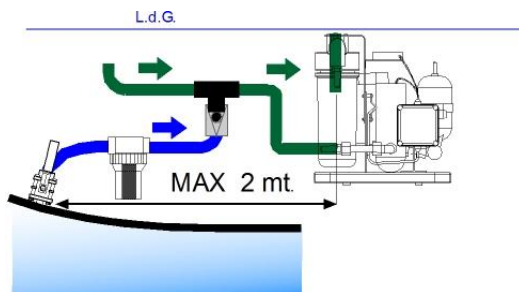

The hydraulic section that is continuously under consistent pressure is the pump outlet – 5 m. filter – watermaker inlet connections. For this section is necessary to use a good quality **PN 16 min.** reinforced hose. An inadequate hose could burst, jeopardizing seriously the safety of the boat.

The hydraulic connections are:

| | | |
|--|---|--|
| <p>Low pressure connections – max 3 bar</p> | <ul style="list-style-type: none"> • Connection between seawater intake – net filter – non-return valve inlet – pump group | <p>Armorvin reinforced pipe PN6 with 16 mm internal diameter</p> |
| <p></p> | <ul style="list-style-type: none"> • Connection between the discharge of the watermaker – through hull discharge fittings of the vessel | <p>Armorvin reinforced pipe PN6 with 16 mm internal diameter</p> |
| <p>Medium pressure connections – max 13 bar</p> | <ul style="list-style-type: none"> • Connections fresh water pressurized system– carbon filter-backflow valve outlet–pump inlet • Connections pump outlet-5 microns filter– watermaker inlet. | <p>Rubber reinforced pipe PN 16 minimum, internal diameter 16 mm.</p> |
| <p>Low pressure connections - max 3 bar</p> | <ul style="list-style-type: none"> • Watermaker - fresh water tank | <p>¼” fittings, Small plastic blue pipe 6x8mm provided within the scope of supply</p> |
| <p></p> | <p></p> | <p></p> |



PUMP CONNECTIONS:

Connect the in/out hose to the pump as follows:



WATERMAKER INTAKE AND DISCHARGE
FIG. 4-2



CAUTION

The pump has to be placed as close as possible to the seawater intake and as low as possible respect to the seawater level; furthermore, it is recommended to avoid long and windy path of the connection hoses.



ATTENTION

The use of an improper hose can cause a break which prevent the security of the boat.

WATERMAKER CONNECTIONS:

WATERMAKER INLET (Sea water inlet from the pump):

Make use of the external holder located on the left side of the watermaker (marked **IN**).

WATERMAKER OUTLET (Discharge outboard):

Make use, for this connection, of the holder located on top of the pressure amplifier, inside the watermaker unit (marked **OUT**). Create a Swan neck upward, when the drain outlet on the vessel is positioned below the watermaker unit, in order to guarantee a water head.



PRODUCTION FRESH WATER CONNECTION

The connection has to be made using the small hose supplied with the equipment. The connection has to be made between the polyethylene pipe that comes out the watermaker unit (on the right), and the upper side of the tank, on a 1/4" outlet if available.

It is possible, in case of metal tanks, to make a 1/4" threaded hole to connect the supplied male connector. Another option is to Tee into the tank air vent hose. There are no particular limits on the connection length.

4.5 Electric connection



ATTENTION

These steps have to be performed by a qualified technician/operator, by referring to the electrical drawings provided within this document.

4.5.1 Remote control panel mounting

The remote control panel has the following dimensions:

width 10 cm height 8 cm.

It can be fixed on any internal boat panel, provided that the area behind is free of humidity and condense and there is enough depth to house the rear part of the panel (approx. 8 cm.).

The cut to be performed on the boat covering panel, to encase the remote control panel, has the following dimensions:

width 7 cm height 5,5 cm

The remote control panel can be connected through the pre-wired multiple cable of a 10mt standard length provided. It is possible to adapt the panel to a longer distance by adding a one more cable in series to the one provided.



REMOTE CONTROL PANEL
FIG. 4-3

4.5.2 Electric connections: wires (SMART 80 230V AC)

The electric connectors are positioned inside the small electric box connected to the computer box. The power supply, coming from the power generator, needs to be connected to the specific terminals of the pump box. The connection to the boat panel needs to be performed downstream the voltmeter and the ammeter of the boat panelboard. The connecting terminal must be suitable to support the plant electric load (approx. 400 Watt). A 5 Ampere automatic circuit breaker for 230V AC systems must be installed on the power supply.

The connection general diagram is the following:

| Clamp | Position | connect to | cable section |
|-------|--------------|---------------------------------|--------------------------|
| F | Pump box | 230 V power generator | 2,5 mm ² min. |
| N | Pump box | 230 V power generator | 2,5 mm ² min. |
| G | Pump box | 230 V power generator | 2,5 mm ² min. |
| A | Pump box | Computer box | 2,5 mm ² |
| B | Pump box | Computer box | 2,5 mm ² |
| - | Computer box | electrovalve (on the AC filter) | 2,5 mm ² |
| 10 | Computer box | electrovalve (on the AC filter) | 2,5 mm ² |
| + | Computer box | positive battery/charger | 2,5 mm ² |
| - | Computer box | negative battery/charger | 2,5 mm ² |

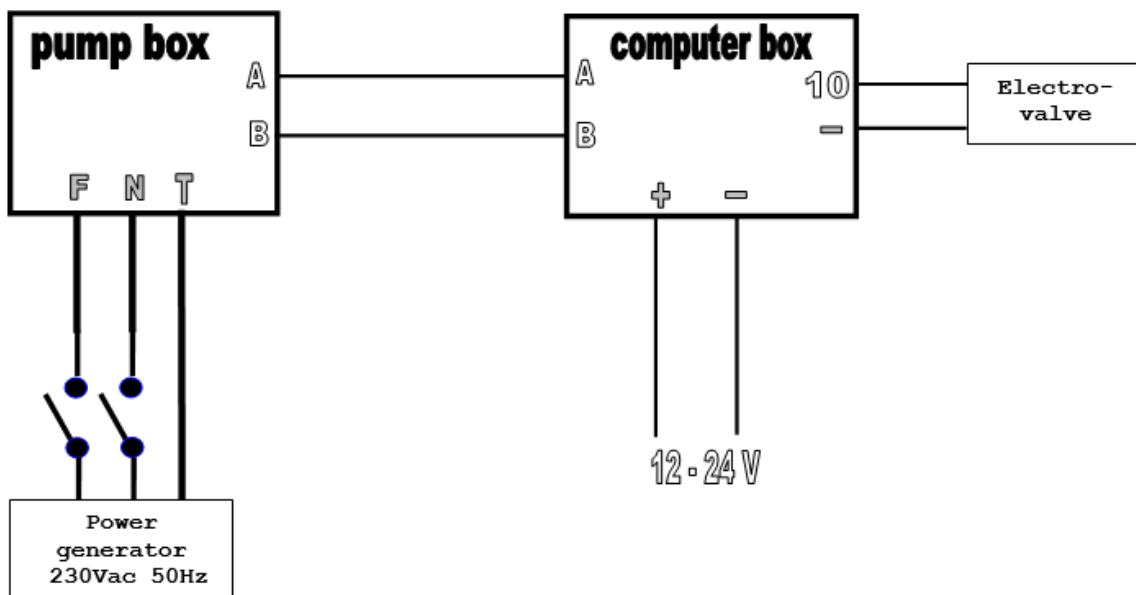

WIRING LOGIC SCHEME 230 VAC
FIG. 4-4

4.2.1 Electric layout scheme (230V AC)

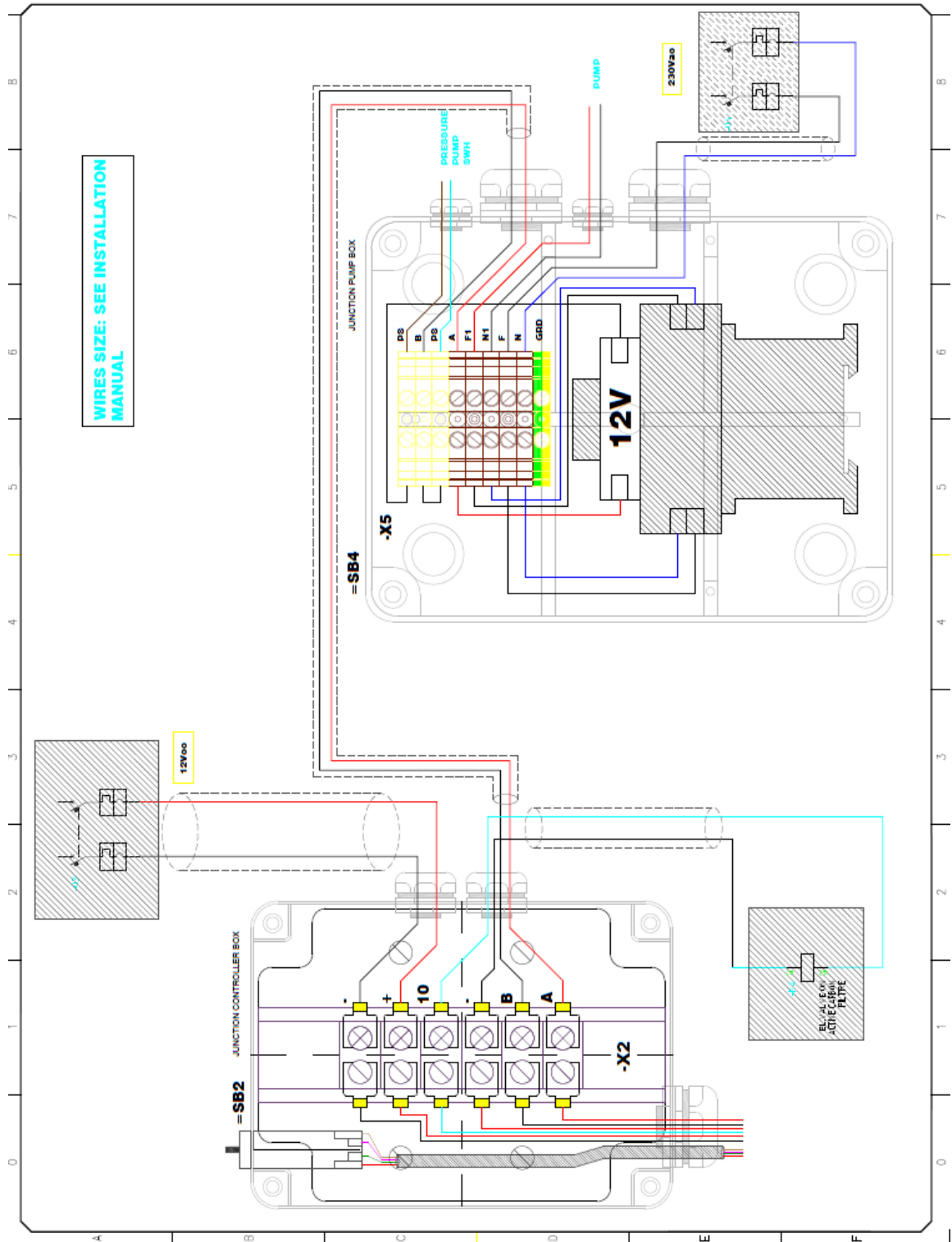

ELECTRIC MAIN BOX SCHEME SMART 80 230V AC
FIG. 4-5

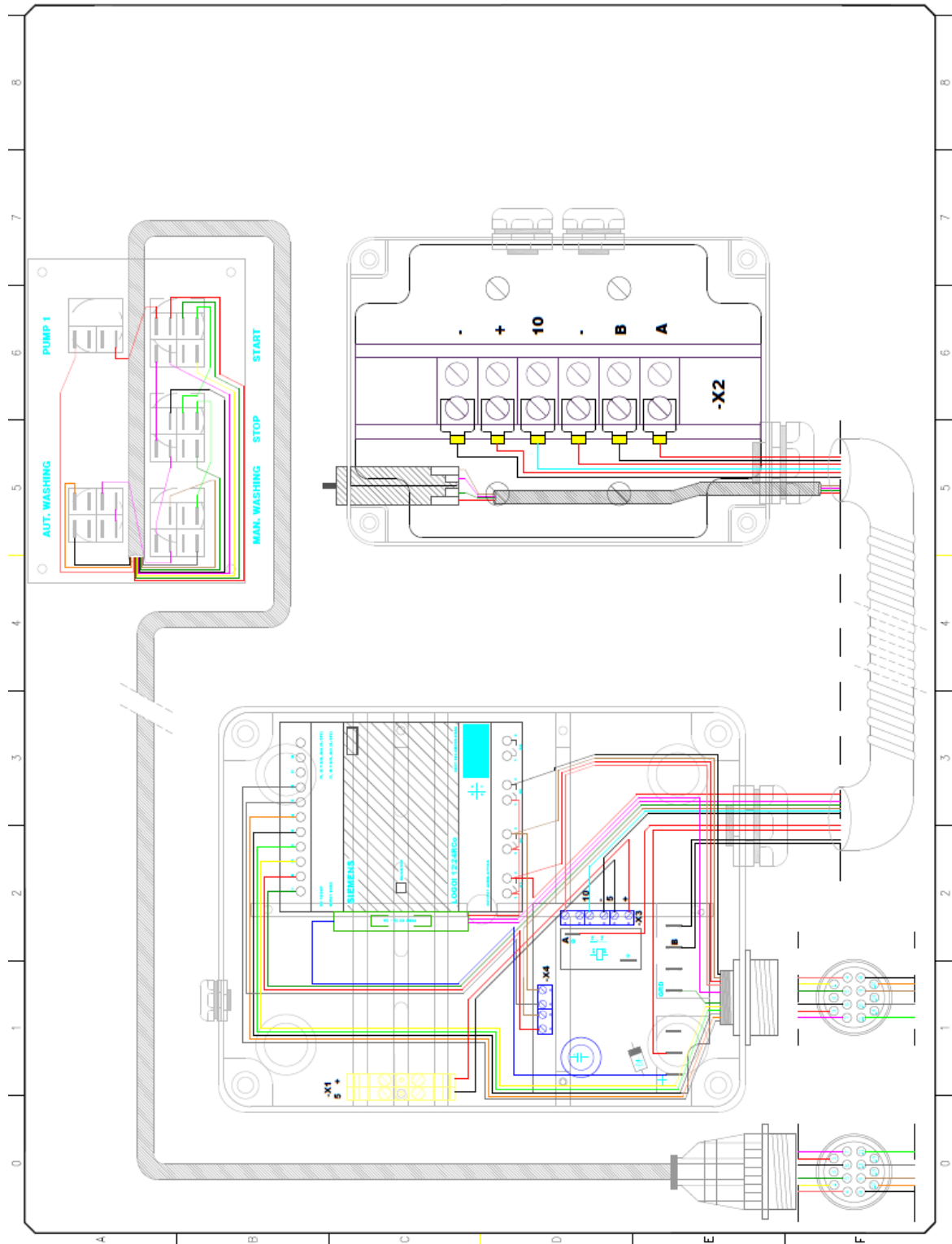

ELECTRIC MAIN BOX SCHEME WITH REMOTE PANEL SMART 80 230V AC
FIG. 4-6

5. FUNCTIONING AND USE

5.1 Command description



Remote control panel
Fig. 5.1

Commands and indications of the remote panel are the following:

- **PUMP 1:** It is a selector. It allows the starting of the pump.
- **AUT WASHING:** It is a selector. It allows the starting of the automatic washing procedure when the unit is stopped.
- **START:** It is a push-button used to start the unit.
- **STOP:** It is a push-button used to stop the unit. It includes a lamp that recognizes different alarm conditions.
- **WASHING** It is just a lamp. It is “on” during the automatic washing of the unit.

The STOP lamp identifies the following alarm conditions:

- **Blinking light (slow period – 1 sec.)** It identifies a low-pressure alarm. This alarm switches off automatically the system.
It is necessary to recognize the alarm (pushing STOP) and eliminate the origin of the faulty condition.
- **Blinking light (fast period – 0,5 sec.)** It identifies either the high pressure or the absence of cycling (no signals from the probe-signal pressure switch). This alarm switches off automatically the system as well.
It is necessary to recognize the alarm (pushing STOP) and eliminate the origin of the faulty condition. If the fault is related to a signal pressure switch malfunctioning, it is possible to start the system by activating the by-pass selector.

5.2 Introduction – by pass mode

The watermaker makes use of a bypass mode which disables all the electronic main functioning (diagnosis, automatic washing etc.). In this way the system works manually.

The bypass mode has to be activated only in the following situations:

1. First start-up procedure or restarting of the watermaker after service operation. The bypass is needed to purge the whole residual air which would otherwise be interpreted by the system as a fault, with a consequence of a system block after about 20 sec.
2. Electronic fault. In case of electronic control fault, the bypass mode guarantees the normal functioning of the watermaker manually through the use of the pump1 selector. In this circumstance it is not possible to perform the automatic washing.



CAUTION

Please, avoid to use the bypass mode if not strictly necessary. In this mode all the main electronic controls of the watermaker and automatic sensors are disabled.

5.3 First start up procedure

The first start-up procedure is necessary to start a new plant for the first time or to restart it after having performed the laying up procedure.

The purpose of the star up procedure is to essentially purge the air contained in the system.

This procedure has to be performed by making the watermaker functioning manually; this option is carried out by activating the bypass mode, which bypass the electronic controls.



CAUTION

When by-pass mode is "ON", all the electronic controls (diagnosis, automatic washing, etc..) are disabled.



Electric connection box
Fig. 5-2

5.3.1 Manual mode activation through the bypass selector switch

The bypass mode can be activated by switching the selector placed on the right side of the electronic main box.



NOTE

The bypass mode “on” is advised by the continuous light of the green led on the START button.

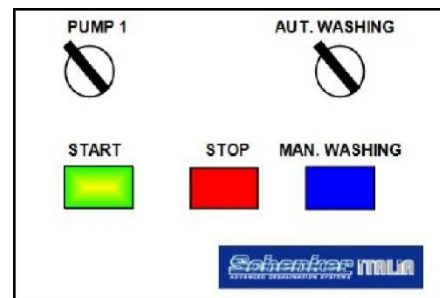





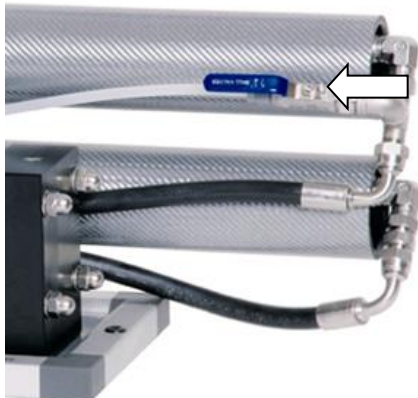

5.3.2 Preliminary checks before proceeding with the startup procedure

Please, be sure to perform all the following checks before proceeding with the startup procedure:

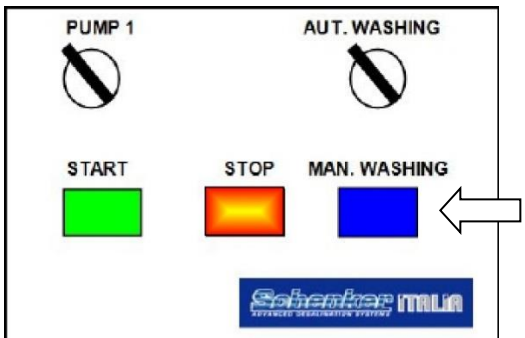
1. Verify that all plant components are connected correctly.
2. Verify the 5 micron is installed correctly.
3. Be sure the seawater inlet valve and salt water drain valve are opened (If existing).
4. Be sure the reset valve is closed (lever **orthogonal** to the body valve) and the positioner completely unscrewed.
5. Be sure the fresh water pressurizing pump of the boat is on.
6. Be sure the valve on the active carbon filter is opened.
7. Be sure the fresh water tank is full enough (at least 100lt) to perform washing procedure.

5.3.3 Start up

| | |
|--|--|
| <p>1. Open the depressurization valve (lever horizontal)</p> |  |
| <p>2. Push for 20-30 sec the red button on the active carbon filter housing cup in order to purger the air from the system.</p> |  |
| <p>3. Leave vertically positioned the Pump1 and Aut. Washing selectors in off position; 4. Push the Man. Washing button. In this condition the electrovalve is opened and the pump is primed. After about 20 seconds the red led will start flashing. Please, reset the alarm by pushing the STOP button. Perform again the last step.</p> |  |
| <p>5. Switch on the bypass selector (positioned under the box).</p> |  |

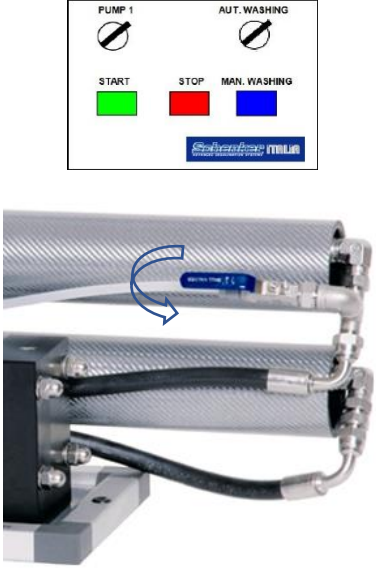
| | |
|---|---|
| <p>6. Start the system by turning clockwise the Pump 1 selector. The command starts pump 1 and the system purges from undesired air. After 3-4 minutes switch off the Pump 1 by turning Pump 1 selector counterclockwise.</p> |  |
| <p>7. Switch off the bypass by turning counterclockwise the selector under the electric box. The green Led will switch off.</p> |  |
| <p>8. Turn clockwise the Pump1 and Aut. Washing selectors and close the depressurization valve (lever in vertical position).</p> <p>9. Press the START button. The system starts to pressurize and the fresh water production begins. Verify that no leaks occur. After about 3 minutes, push STOP button. The system activates washing procedure automatically and switches off after about 40-50 seconds.</p> <p>The system is now correctly purged and it is ready to operate normally.</p> |  |

5.4 Normal operating procedure

Please, be sure to perform all the following checks before proceeding normal operating procedure:

1. Be sure the reset valve is closed (lever **orthogonal** to the body valve) and the positioner completely unscrewed.
2. Be sure the depressurization valve is closed.

5.4.1 Normal operating procedure with automatic washing on (advisable procedure)

1. Switch on the pump by rotating clockwise the Pump 1 selector.
2. Switch on the Automatic Washing selector.
3. Push the button START. The green led will switch on and the production starts.
4. Push the STOP button when finishing the running time needed.
The automatic washing will start and the blue led will switch on for the whole washing time (around 1 minute).
The system will switch off automatically after when the automatic washing is complete.

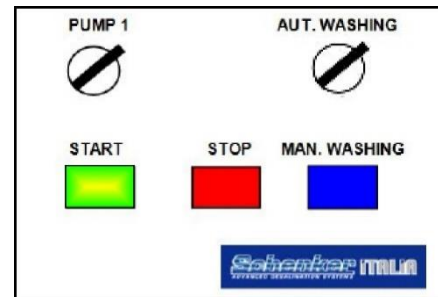

The fresh water consumed for the automatic washing is about 25 lt.

5.4.2 Normal operating procedure with automatic washing off (not advisable procedure)



CAUTION

It is not advisable to use the watermaker without automatic washing on because the deposit of salt within the system for long period could damage the pump and reverse osmosis membranes.

1. Switch on the pump by rotating clockwise the Pump 1 selector.
2. Switch off the Automatic Washing selector.
3. Push the button START. The green led will switch on and the production starts.
4. Push the STOP button when finishing the running time needed.

Do not switch off the system by acting on the pump1 selector in order to avoid hydraulic faults of the unit.

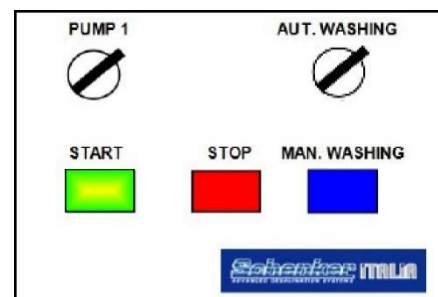

NOTE

It could occur that the system doesn't stop immediately when stop button is pushed, but it rather stops after a while. This behaviour is absolutely normal because the electronic central unit waits for the hydraulic clock signal before switching off in order to avoid hydraulic system block.



CAUTION

If during normal running operation the computer detects an irregular condition (not constant cycling, low pressure, etc...) the system switches off automatically after 20 sec, and STOP led will start flashing. To make watermaker run again, it is first necessary to press STOP button (in order give a feedback to the system that the issue has been recognized). Before pressing STAR to run the watermaker again, be sure to individuate the cause of the anomaly and solve the issue.

5.5 Manual washing procedure



NOTE

Manual washing is a procedure advised only in case of long term inactivity of the watermaker (2/3 months could be considerate a period of time that requires a manual washing).





NOTE

During manual washing the watermaker does not produce fresh water. Indeed the procedure has the goal to rinse the system before long period of inactivity.



CAUTION

Before performing a manual washing procedure, please verify to have an adequate reserve of fresh water in the tank before proceeding, taking into account that for a correct washing an amount of 10lit/min will last, for at least 10 minutes of washing.

| | |
|--|--|
| <ol style="list-style-type: none"> 1. Switch on the pump by rotating clockwise the Pump 1 selector. 2. Switch off the Automatic Washing selector. (AUT.WASHING in vertical position) |  |
| <ol style="list-style-type: none"> 3. Push the button MAN. WASHING to start the washing cycle. The green led (START) and the blue led (MAN. WASHING) will switch on and the procedure starts. 4. Push the STOP button to end the flushing procedure after around 10 minutes. |  |



CAUTION



It is advisable to not exceed 10 minutes manual washing, being it an adequate time to correctly rinse the membranes and guarantee the complete removal of the salt in the watermaker.



5.6 Reset procedure

If the watermaker get air (or if some other problem occurs), the automatic hydraulic valve may stop in a central position. This means that pressures on both sides of the valve are the same and the unit is effectively stalled. In this case the system has to be manually restarted.

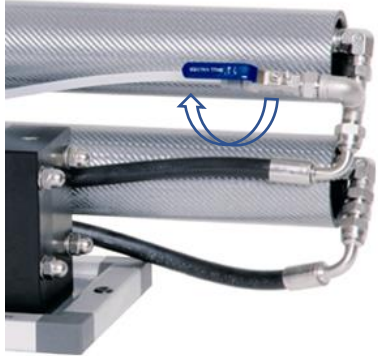
An evidence of this effect is confirmed by a working pressure going up suddenly. After approx. 20 sec. the computer recognizes the problem, turn off the pumps, and the red led start flashing.

This event, besides being very unusual, does not damage the system, but it is necessary to reset the valve with the following simple procedure:

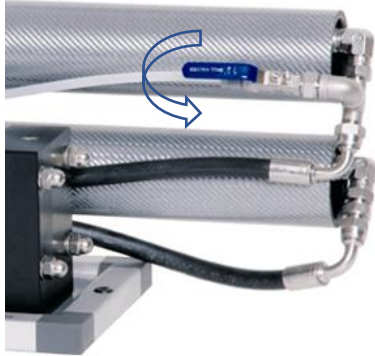
| | |
|---|--|
| <ol style="list-style-type: none"> 1. Turn off the system 2. Open the reset valve (lever in horizontal position). |  |
| <ol style="list-style-type: none"> 3. Open the depressurization valve at 45°. |  |
| <ol style="list-style-type: none"> 4. Screw the positioner knob clockwise until it can be moved no further. Normally 10 turns at least are needed. |  |
| <ol style="list-style-type: none"> 5. Unscrew the positioner knob counterclockwise up to the original position, until when it is blocked back. |  |
| <ol style="list-style-type: none"> 6. Close the reset valve (lever in vertical position). | |

| | |
|---|---|
| |  A black Schenker valve assembly with a blue curved arrow indicating a clockwise rotation of the handle. |
| <p>7. Close the depressurization valve.</p> |  A stainless steel depressurization valve assembly with a blue curved arrow indicating a clockwise rotation of the handle. |
| <p>8. Restart the system</p> |  A control panel with four buttons: 'PUMP 1' (black with a diagonal line), 'AUT. WASHING' (black with a diagonal line), 'START' (green), and 'STOP' (red). A blue 'MAN. WASHING' button is also present. The Schenker logo is at the bottom. |

6. MAINTENANCE (ROUTINE AND EXTRAORDINARY)



6.1 Control of filter cleaning condition

It is very important to inspect filters condition periodically.

The following filters are present in the system:

1. Net filter (strainer)
2. Pump filter (5 micron cartridge filter – white filter housinh)
3. Active carbon filter

follow the instructions given in the table below:

| OPERATION | FREQUENCY | PROCEDURE |
|---|---|---|
| Check and cleaning of the strainer | Every 5 days | <p>Visual inspection and washing</p>  |
| Replacing of the 5 micron cartridge filters | Every 200 working hours. Once replaced the filters it is necessary to purge the air from the system, opening for 2-3 minutes the depressurization valve. | <p>Unscrew the filter housing cup counter clockwise by using the specific key provided</p>  |
| Replace the active carbon fiber filter | Once per year | <p>Unscrew the filter housing cup counter clockwise by using the specific key provided</p>  |

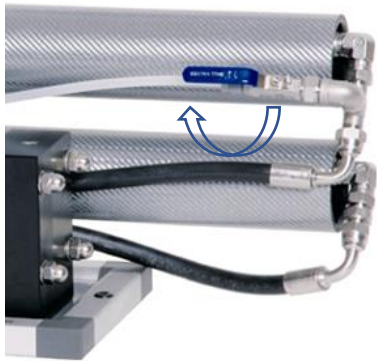
| | | |
|---|-------------------------|--|
| <p>Purge air from the system periodically by opening for 2-3 minutes the depressurization valve at 45°.</p> | <p>Every 15-20 days</p> |  |
|---|-------------------------|--|

6.2 Check the plant working pressure

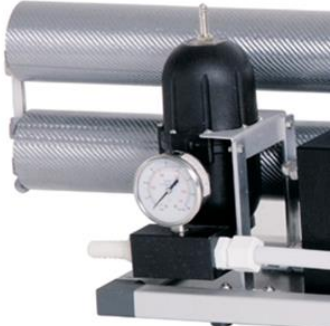
| | |
|---|---|
| <p>It is necessary to read the pressure on the manometer located on the equipment front panel in order to perform this verification. The working pressure depends on many factors such as water temperature, salinity level of seawater, effective batteries voltage, membranes cleaning degree, typology of installation. The pressure, in normal working conditions, is approx. 7 – 8 Bars. There is a small pressure lost head, in the range of 0,2 bar, during the cycle.</p> |  |
|---|---|

If the average pressure exceeds the above ranges it is necessary to check the membranes cleaning degree. It is necessary to perform the shutdown procedure if the membranes result dirty. If cleaning also results insufficient it could be necessary to perform an alkaline washing using the chemical product SCHENKER CLEANING 2 (SC2). It is recommended to contact a Schenker certified service center.

6.3 Check for absence of leaks

It is necessary to perform this verification at every plant start-up and however often, since possible leaks due to accidental causes (pipe bursting, hose clamp loosening, equipment failure, etc.) may occur, even plentiful, with the consequence of possible damages.

6.4 Check for membranes replacement

The reverse osmosis membranes have a 7 years average working life. It is recommended therefore, after 5 years of operation, to verify the possible necessity of substitution and however to perform the substitution after 7 years.

6.5 Shutdown procedure

It is necessary to perform the shutdown procedure before standstills longer than 3 months, for instance before the winter laying up.

The purpose of the shutdown is to flush the system from possible organic and inorganic sediments, and inhibit the growth of bacteria that could reduce the reverse osmosis membranes efficiency.

6.5.1 Necessary Equipment

The following equipment is necessary to perform the shutdown operation:

1. 1 tank of fill with at least 20 liters of fresh
2. 3 hoses to be connected to:
 - inlet of the pre-pump
 - discharge of the watermaker
 - fresh water production of the watermaker.
3. A bottle of powder **SCHENKER CLEANING 1 (SC1)**. The solution must be prepared following the instruction indicated on the product label, and **using chlorine free water** (water produced by the system can be an option).
4. Tools for dismounting the system's pipes (screwdrivers, pliers, etc.)

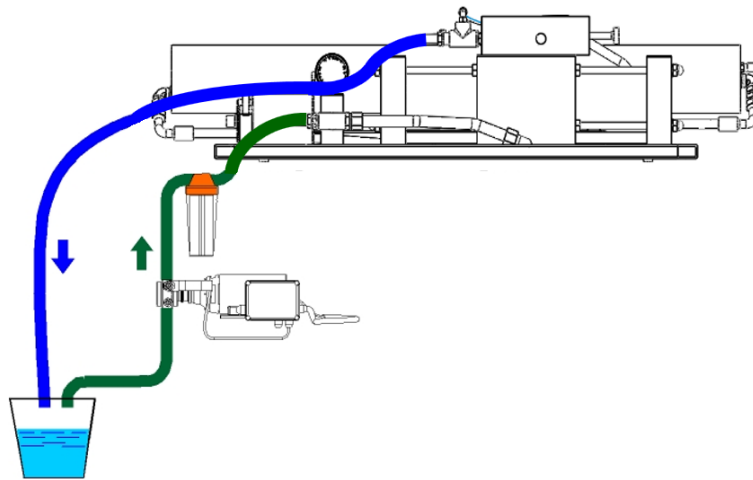

HYDRAULIC SCHEME FOR SHUTDOWN PROCEDURE
FIG. 6-1



NOTE

The available products for the shutdown procedure are the following:

1) SCHENKER CLEANING 1 (SC1 – Acid product) to remove the inorganic components and preserve the watermaker during winter break

2) SCHENKER CLEANING 2 (SC2 – Alkaline product) to remove the organic components (mould and bacteria) when already deposited; in this case the system becomes stinky.

Whether the system needs acid or alkaline cleaning will depend on the type of foulant suspected. However, both kinds of cleaning are needed and it is recommended to start with the alkaline cleaning then follow with the acid cleaning after the system has been flushed.



NOTE

Normally only SC1 is required, but in case of strong smell it is recommended to use also the SC2.

The sequence in this case will be SC2 first, then a washing of the system. Finally the SC1, then again washing of the system.

It is advisable to replace the filters after performing shutdown procedure with new ones.

6.5.2 Shutdown operating procedure

| | |
|--|--|
| <p>1. Disconnect the production pipe and collect about 20 liters of fresh water within a tank.</p> |  |
| <p>2. Switch off the system by pushing the stop button.</p> |  |
| <p>3. Prepare the solution carefully mixing the bottle of SC1 in about 20 liters of unchlorinated water.</p> |  |
| <p>4. Connect the 3 hoses to the pre-pump and watermaker as indicated above, and dip them in the solution.</p> | |

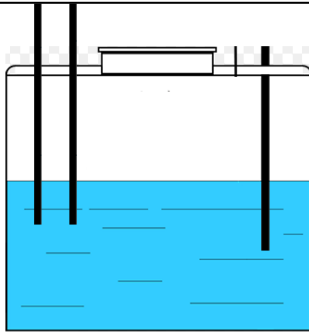
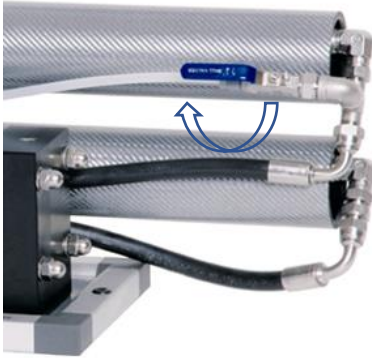
| | |
|--|--|
| |  |
| <p>5. Check they are well dipped in the solution and don't inhale air.</p> | <p style="text-align: center;">Pipes under the free water surface</p>  |
| <p>6. Open the depressurization valve (turn counterclockwise).</p> |  |
| <p>7. Start the watermaker with the by-pass activated (see pag. 32 for bypass activation).</p> | |

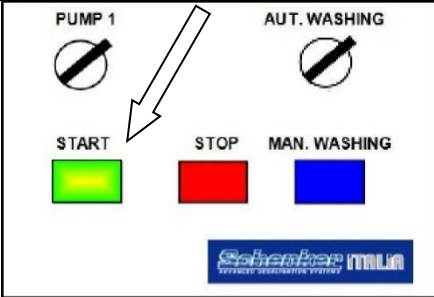
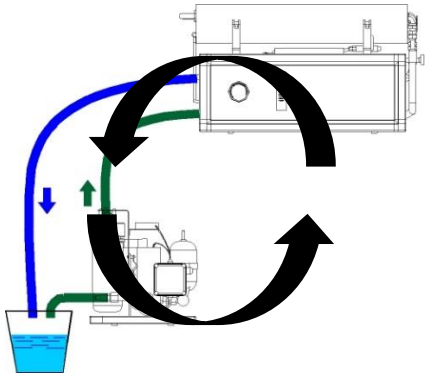
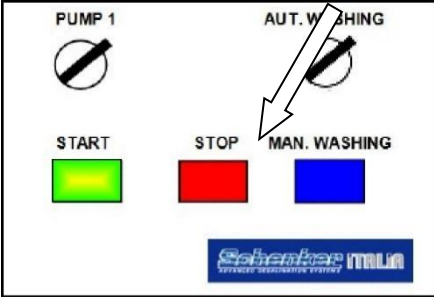
| | |
|---|--|
| |  |
| <p>8. Leave the unit running for approx. 20 minutes, checking that the hoses are properly positioned in the recipient, so that to avoid inhaling air.</p> |  |
| <p>9. Shut the plant off and connect the original hoses.</p> |  |



CAUTION

It is necessary to perform the first start-up procedure when restarting the plant after a shutdown procedure, in order to purge the air and drain out board the chemicals in the systems.

6.6 Antifreeze procedure (Winterizing procedure in cold climate - under 5°C)

It is recommended to first perform the normal shutdown procedure by using SC1 in order to clean the system properly and prevent bacteria growth and inorganic material deposit.

After this operation, Then the system must be flushed and filled with an antifreeze.

The recommended antifreeze product is a solution of **propylene glycol and unchlorinated water**.

The ideal concentration of propylene glycol is

- 45% (for temperatures up to - 20°)
- 55% (for temperatures up to - 30°).



ATTENTION

Do not use ethylene glycol as this substance is toxic and non-degradable.

The total volume of the solution must be about 15 liters.

The procedure is similar to that used for chemical washing with SC1 and SC2 products:

1. **Prepare the solution carefully mixing the propylene glycol with 15 liters of unchlorinated water** by following the concentration suggested above.
2. Disconnect the drain hose and the pumps suction hose.
3. Connect two hose pieces to the drain and to the pump suction.
4. **Insert the end side of the hoses into the bucket, verifying that the hoses have been properly dipped in the solution and that they don't inhale air.**
5. **Open the depressurization valve at 45°.**
6. **Start the watermaker with the by-pass activated.**
7. **Leave the unit running for approx. 15/20 minutes, checking that the hoses are properly positioned in the recipient, so that to avoid inhaling air or spilling the liquid into the boat.**
8. **Shut the plant off and connect the original hoses taking care of not empty the system during out the solution.**

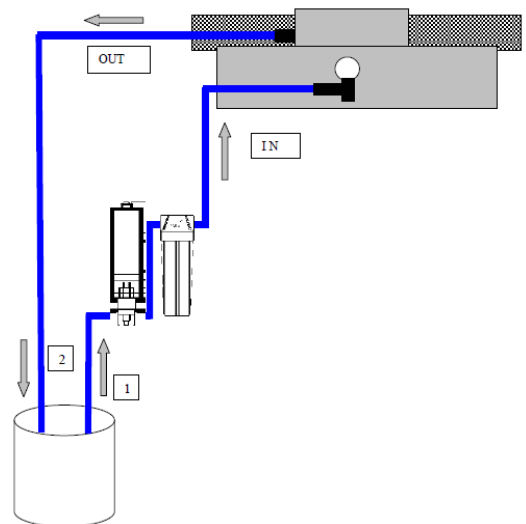

HYDRAULIC SCHEME FOR
WINTERIZING PROCEDURE
FIG. 6-2



ATTENTION

It is necessary to perform the first start-up procedure when restarting the plant after a shutdown procedure, in order to purge the air and drain out board the chemicals in the systems.



Before proceeding with any kind of service it is strongly recommended to read carefully the instruction contained in this manual.

6.7 Periodic maintenance

6.7.1 Membrane replacement

Reverse osmosis membranes have an average lifetime of about 7 years if correctly maintained. It is anyway recommended to check the efficiency of the membranes after 5 years of functioning and verify the need of a replacement. Please, refer to a certified Schenker service center for this operation.

6.8 Adjustments

| | |
|--|--|
| <p>Pump high pressure switch</p> <p>The main pump is equipped with a high pressure switch set at around 13 Bar.</p> <p>The pressure switch can be calibrated with a 2 mm hexagonal key. To have access to the calibration screw it is necessary to operate on the screw that blocks the electrical connector of the pressure switch, and then introduce the hexagonal key (even without removing the electrical connector itself). Turning the key clockwise increases the calibration of the pressure switch, while turning the key anticlockwise decreases the calibration.</p> |  |
| <p>Pulsation dampener</p> <p>It is a cylindrical receptacle of air that has the function of damping the pressure oscillations during the commutations of the watermaker. The dampener is factory loaded at a pressure of about 5 bar. The charge level of the dampener must be periodically checked in order to guarantee a correct functioning to the watermaker.</p> |  |

7. TROUBLESHOOTING

7.1 Failure chart

| Issue | Cause | Remedy |
|---|--|---|
| Pump doesn't start | Pump pressure switch disconnected or burned Electronic issue | Restore or replace the pump pressure switch Activate the by-pass |
| Pump starts but the system suddenly blocks in high pressure | Hydraulic block Dirty filters Obstruct membranes Commutation system block | Perform reset procedure Replace filters Perform washing procedure Contact a customer service |
| During operation, the pump temporarily switches off, giving rise to a start and stop phenomenon | Pump pressure switch not correctly set Dirty filters or membranes | Set pump pressure switch (see pag.47) Clean or replace |
| Metal noise of the pump | Pump cavitation | Check the causes of the absence of water flow at the pre-pump inlet |
| Low production / normal or low pressure | Low battery Air within the system Loss of sealing systems | Check battery charge Purge the air out of the system Contact a customer service |
| Low production / high pressure (> 13 Bar) | Dirty filters Obstruct membranes Cold inlet water | Replace filters Perform washing procedure Contact a customer service |
| Loss in the system | Loose fittings ERS leaks | Tighten fittings Contact a customer service |

7.2 Electronic issues and their solution

- **Pushing the start button the system does not start:**

Check that the by-pass is excluded (selector turned anticlockwise) and that the pumps are activated (pump 1 selector turned clockwise).

Still the system does not start ...

Check that the system is electrically connected, according to the diagram shown in the manual, and that the main magnetothermal switch is activated.

Still the system does not start ...

Check if power supply to the electrical box arrives, measuring the voltage with a tester between the + and - terminals

If the system starts (the green light of the start button lights up, and after about 20 seconds the system goes into alarm, since the pump is not started) the problem is due to the insufficient battery charge. Charge the batteries and try again.

If the system does not start, check all the electrical connections between the remote panel and microcomputer again and replace the microcomputer box or the connection cable or the remote panel if necessary.

- **Pressing the start button the system starts but goes into alarm after about 25 seconds.**

Check if the watermaker is in hydraulic block (pressure indicated by the pressure gauge above 9-10 bar and pump off). In this case, carry out the reset procedure indicated in the manual and restart the system.

Still the system does not start (it goes on the block after about 20 seconds).

Disconnect the pressure switch from the terminal board. Activate the system manually by inserting the by-pass. Measure the operation of the pressure switch with a tester in "ohm" position. The pressure switch must give, under normal conditions, a closing signal followed by an opening signal, every 3-4 seconds.

If the signal is always open or always closed, the pressure switch must be replaced

8. SUGGESTED SPARE PARTS

8.1 Short term cruising

For short term cruising it is advisable to have onboard a cleaning kit (one SC1 and one SC2 cleaning product) as well as one 5 micron cartridge filter. Other additional spares are listed below with their codes:

| Spare part name | Code |
|--------------------------------|-------|
| SC1 WASHING PRODUCT | SC1 |
| SC2 WASHING PRODUCT | SC2 |
| CLEANING KIT BIG (SC1+SC2) | CKBIG |
| 5 MICRON CARTRIDGE 9 3/4" | F5 |
| ACTIVE CARBON FILTER CARTRIDGE | CA |

8.2 Long term cruising

For long term cruising it is advisable to have onboard a cruising kit (three 5 micron cartridge filter, one active carbon filter, one cleaning kit big) as well as one 2540 SW membrane and a signal pressure switch. Other additional spares are listed below with their codes:

| Spare part name | Code |
|--|-----------|
| SC1 WASHING PRODUCT | SC1 |
| SC2 WASHING PRODUCT | SC2 |
| CRUISING KIT | CRK136 |
| PUMP HEAD 80 L | SP80 |
| PUMP MOTOR 80/100 220V | MP10/220 |
| MEMBRANE 2540 | M2540 |
| PORTABLE SALINITY TESTER | PST |
| SIGNAL PRESSURE SWITCH SMART30/60/80/100 | PSSS361 |
| PUMP PRESSURE SWITCH 80/100 | PSP10 |
| SPARE SEALS KIT 2.0 | SS152-2.0 |

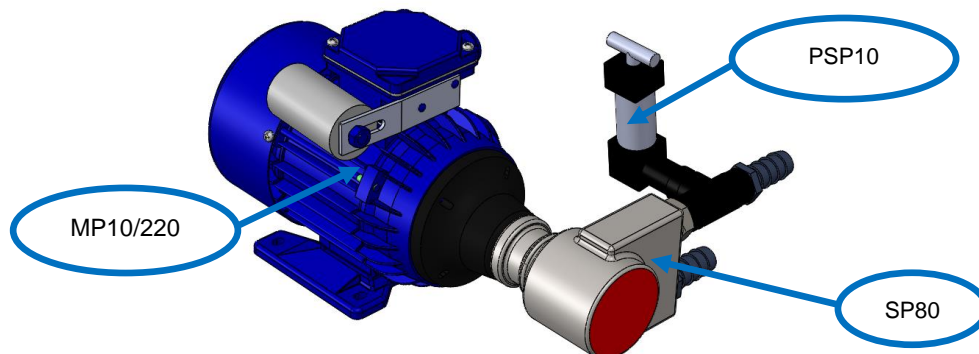

8.3 ERS spare parts

| N° | DESCRIPTION | Code |
|----|---|----------|
| 1 | CENTRAL SECTION BOTTOM PARTS ERS 30_60_80 | CCE368 |
| 2 | MAIN ROD 30_60_80 | MRD36 |
| 3 | CYLINDER END CUP OPEN 30_60_80 | CEC/0368 |
| 4 | PISTON 30_60_80 | PST36 |
| 5 | CARBON FIBRE CYLINDER 30_60_80 | CYL36 |
| 6 | CARBON FIBRE BOTTOM PIPE 30_60_80 | CYC |
| 7 | CYLINDER END CUP BLIND 30_60_80 | CEC36 |
| 8 | VALVE ROD | VRD |
| 9 | RIGHT VALVE 30_60_80_100 | RV |
| 10 | LEFT VALVE 30_60_80_100 | LV |
| 11 | CENTRAL VALVE 30_60_80 | CV-S36 |
| 12 | VALVE PISTONS KIT 30_60_80_100 | VPK2.0 |
| 13 | ERS NON RETURN VALVE KIT 30_60_80 | ENRV36 |

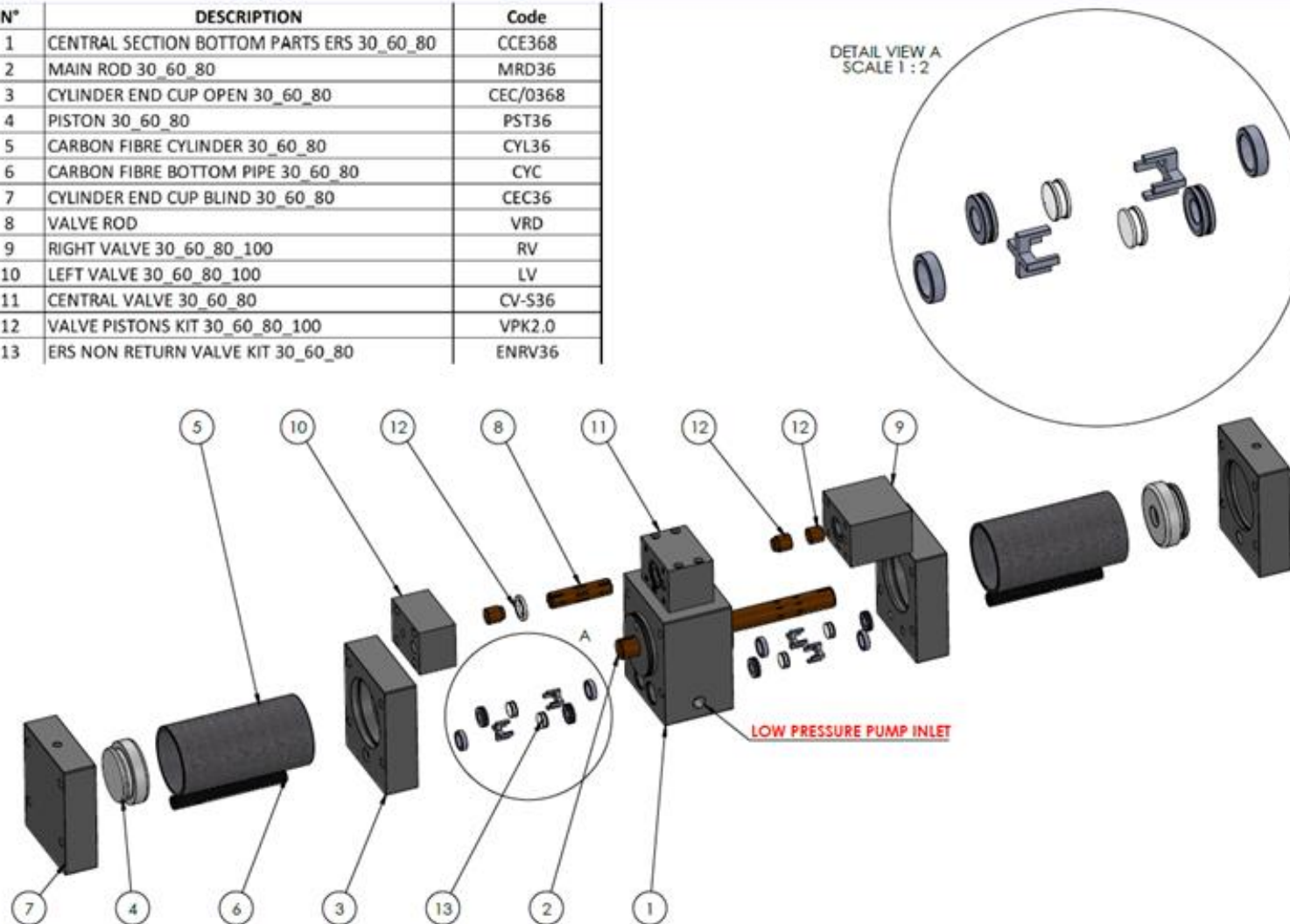

8.4 Additional spares

For extraordinary maintenance intervention that might become necessary in order to ensure the normal operating condition of the watermaker, other common spares are listed below with relative images and codes:

| Spare part name | Code |
|---------------------------------------|---------|
| COUPLE HIGH PRESSURE HOSE SM 30/60/80 | HPH |
| END CUP VESSEL 2,5" SINGLE CONNECTION | EV2,5 |
| END CUP VESSEL 2,5" DOUBLE CONNECTION | EV2,5-2 |
| "C" END CUPS 2,5 CONNECTION FITTING | CEV4 |
| MANOMETERS 0-16 | M16B |

