



easyRESCUE
User Manual

English

Version 3.3

easy
RESCUE 

Contents

1	Safety information.....	7
2	Equipment delivered.....	9
3	Abstract	10
3.1	AIS Function.....	11
3.2	DSC Function.....	12
3.3	Homing Function.....	14
4	Functions	15
4.1	Device overview.....	15
4.2	LED Elements	16
4.2.1	LED „FLASH“.....	16
4.2.2	LED „TEST“	16
4.2.3	LED „ON“ / „DSC“	16
4.2.4	LED „GPS“	17
4.3	Sliding Cover.....	18
4.4	ON Mode (Alert).....	19
4.4.1	Overview Sent Signals.....	19
4.4.1.1	AIS Emergency Signal.....	19
4.4.1.2	DSC Emergency Signal	19
4.4.1.3	Homing Signal	19
4.4.2	Overview Triggering Functions	20
4.4.2.1	Manual Activation.....	20
4.4.2.2	Activation via Water Contact	21
4.4.2.3	Activation through Magnetic Switch	21
4.4.3	Deactivation	22
4.5	TEST Mode	22

5	Installation Details	25
5.1	Life Vest	25
5.2	Accessories	26
5.2.1	Belt clip	26
5.2.2	Telescopic Rod	27
5.2.3	Attachment to Life Raft.....	28
5.2.4	Neoprene bag.....	29
6	Programming of the MMSI for DSC Alerts.....	30
6.1	Programming via App	31
6.2	Programming via DSC „Individual Call“	36
6.3	Programming via Programming Station	37
7	Technical specification	38
7.1	AIS SART.....	38
7.2	DSC MOB (supplemental to 7.1)	40
7.3	HOMING (supplemental to 7.1)	40
8	Troubleshooting.....	41
9	Maintenance	43
10	Contact and Product Support.....	43
11	easyRESCUE – Database	44
12	License Agreement	45
13	Warranty.....	45
14	Notes.....	48

Revision level of the manual

Version 3.0 Creator: SW/VV; As of Oct. 2016

Version 3.1 Creator: MK/VV; As of Aug. 2017

Version 3.2 Creator: VB/VV; As of Apr. 2019

Version 3.3 Creator: MK/VV; minor changes

The easyRESCUE is approved by the following authorities and institutions:

- **BSH (German Maritime Federal Agency)**
BSH 4581 / 001 / 4552745 / 15
- **FCC (US Federal Communication Commission)**
ZO5WDC-A040
- **United States Coast Guard**
- **IC (Industry Canada)**
11269A-RESCUE
-  **ATEX (Bei Geräten mit Zusatz „ATEX“)**
II 3G Ex ic IIC T6 Gc

This user manual applies to the following devices:

- easyRESCUE - A040
- easyRESCUE - A040-ATEX
- easyRESCUE - A049
- easyRESCUE - A049-ATEX
- easyRESCUE - A040-BW
- easyRESCUE - A040-BW-COM
- easyRESCUE - A040-BW-COM(LV)
- easyRESCUE - A040-BW-COM-ATEX
- easyRESCUE - A040-BW-COM-ATEX(LV)
- easyRESCUE-PRO - A040-PRO
- easyRESCUE-PRO(LV) - A040-PRO(LV)
- easyRESCUE-PRO(BT) - A040-PRO(BT)
- easyRESCUE-PRO(BT-LV) - A040-PRO(BT-LV)
- easyRESCUE-PRO³ - A04003
- easyRESCUE-PRO³(LV) - A04003(LV)

Hereinafter, all the products of our easyRESCUE series are referred to as Rescue Transmitter.

Due to legal regulations, the enclosed Declaration of conformity has always to be carried aboard!

Abbreviations

AIS	Automatic Identification System
COG	Course over Ground
DSC	Digital Selective Call
ECDIS	Electronical Chart Display
GMDSS	Global Maritime Distress and Safety System
GPS	Global Positioning System
LED	light-emitting diode
MMSI	Mobile Maritime Service Identifikation
MOB	Man over Board
NM	Nautical mile (1NM = 1852m)
SAR	Search and Rescue
SOLAS	Safety of Life at Sea (International Convention for the Safety of Life at Sea)
SOG	Speed over Ground
VHF	Very high frequency
Unit ID	Individual unit identification number

1 Safety information

Please read all safety information and instructions and keep the safety information and instructions for future reference.

- Keep the Rescue Transmitter out of the reach of children.
- Wrongful triggering of the Rescue Transmitter is not a minor offense and may lead to consequential costs.
- The Rescue Transmitter uses lithium batteries, the replacement of which may only be performed by an authorized distributor. The device may be damaged if you use the wrong battery type when performing a replacement on your own.
- If the Rescue Transmitter is used at a temperature below -20°C or over 55°C , the charging capacity of the batteries will decrease. Keep the Rescue Transmitter away from heat and hot environments. Should these warnings be ignored the batteries in the Rescue Transmitter may overheat, explode or catch fire and can cause damage to the device.
- The battery capacity amounts to 10 years. According to the SOLAS requirement, the batteries must be replaced after 5 years and the Rescue Transmitter must be sent back to the distributor for servicing. After being used in an emergency, the Rescue Transmitter requires a check-up by the manufacturer.
- The strong internal VHF transmitter may possibly affect medical devices, such as pacemakers, in their functionality. Please observe a minimum distance of $> 0.3\text{ m}$!

- The strong internal VHF transmitter may impair the function of the compass. Please observe a minimum distance of > 0.3 m!
- The manufacturer does not assume liability for any damage or failures caused by these instructions or for the deletion of data due to malfunction, a faulty battery pack or improper use of the product.
- Use supported and approved equipment only. Unauthorized, altered or modified equipment may cause damage to the Rescue Transmitter, violate legal regulations or impair the flawless operation of radio controlled devices.
- Wipe the Rescue Transmitter with a clean, dry and soft cloth. Do not use spirit or any liquid solvents, chemicals or strong detergents.
- Do not try to open the device on your own. Unauthorized or violent opening may destroy the device and you will lose any claim for warranty.

2 Equipment delivered

- Rescue Transmitter
(easyRESCUE - A040, easyRESCUE - A040-ATEX, easyRESCUE - A049, easyRESCUE - A049-ATEX, easyRESCUE - A040-BW, easyRESCUE - A040-BW-COM, easyRESCUE - A040-BW-COM(LV), easyRESCUE - A040-BW-COM-ATEX, easyRESCUE - A040-BW-COM-ATEX (LV), easyRESCUE-PRO - A040-PRO, easyRESCUE-PRO - A040-PRO(LV), easyRESCUE-PRO - A040-PRO(BT), easyRESCUE-PRO - A040-PRO(BT-LV), easyRESCUE-PRO³ - A04003, easyRESCUE-PRO³(LV) - A04003(LV))
- User manual German / English
- Declaration of conformity
- Belt clip with retaining plate and screws
(only with A040 and A049)

3 Abstract

The devices of the easyRESCUE series are portable, battery-operated AIS emergency transmitters with an integrated GPS receiver.

The devices are suitable for the use in lifeboats, life rafts and life vests and they are approved by SOLAS for the same.

The rescue transmitter works as an AIS-SART (search-and-rescue-transmitter) and can be activated in case of an emergency at sea in order to inform any surrounding ships that are equipped with AIS receivers of your position via radio. Depending on the model, the device also has an additional automatic triggering function upon water contact and/or a magnetic switch with a ripcord (see chapter 4.4.2)

The devices of the easyRESCUE-PRO series also have a DSC transceiver.

In addition to AIS and DSC, devices of the easyRESCUE-PRO³ series also transmit the homing signal on the frequency 121.5 MHz.



The range of the Rescue Transmitter amounts to approximately 5-10 nm (nautical miles) if operated just above the water surface. If the Rescue Transmitter is located more than 1 m above the water surface, the range is approximately 10-15 nm (at a height of the reception antenna of approximately 15 m).

Rescue helicopters can even receive information from the transmitter at a distance of over 40 nautical miles.

The Rescue Transmitter uses the standard AIS position message No. 1, which can be received and displayed by all AIS stations or commercial shipping vessels (Class A) and sports ships (Class B).

Upon activation, the batteries continue to transmit for more than 96 hours at -20°C (under normal conditions longer).

The device is waterproof, floatable and resistant to salt water, oil and sunlight and tolerates a fall from 20 m into the water. The batteries can be replaced. This may only be done by your authorized distributor.

3.1 AIS Function

According to international standards, 8 emergency messages (2x Message 14, 6x Message 1 with position) are sent every minute on two world-standard VHF radio frequencies.

3.2 DSC Function

Only applies to devices of the easyRESCUE-PROI-PRO³ series:

Devices of the PRO series have a built-in DSC transceiver.

In case of activation, the Rescue Transmitter will send additionally a DSC emergency message with GPS coordinates, which is part of the GMDSS rescue chain.

The DSC Receiver receives the acknowledge of the DSC emergency message (e.g. acknowledge of a coastal radio station) and the victim is informed about this activity by a long beep from the internal buzzer as well as by the green DSC confirmation LED of the device, which starts to flash after the acknowledgement. With this reception the DSC transmission will be stopped.

The transmission of AIS continues notwithstanding the above. By activating the device, the transmission of the emergency messages by DSC starts as follows:

(Please see also flow chart on next page)

Step 1:

Sending of emergency message only to saved MMSI without GPS position („closed loop“ = individual call)

Step 2:

Sending of emergency message only to saved MMSI with GPS position („closed loop“ = individual call)

Step 3:

Sending of emergency message to everyone with GPS position (“open loop“ = all ships call)

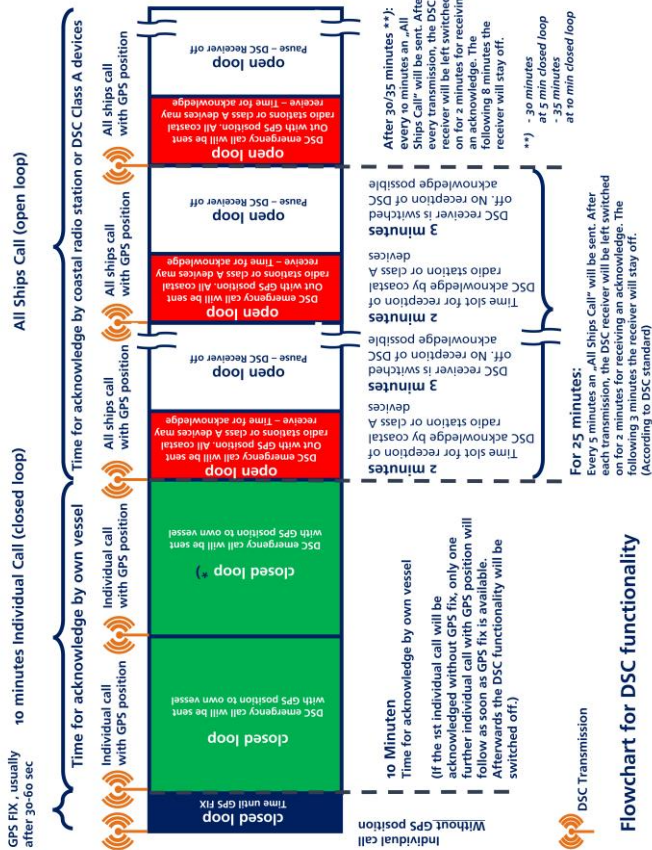

3.3 Homing Function

(Only applies to devices of the easyRESCUE-PRO³ series)

In addition to the two other emergency signals, the easyRESCUE-PRO³ sends another signal on the frequency 121.5 MHz. This allows SAR forces to locate the person overboard. With appropriate reception equipment, as used by the rescue organizations, the so-called "homing signal" can be received and the direction to the victim accurately targeted. Especially when there is no search in sight in the dark, 121.5 MHz direction finding is very helpful. This signal is sent for six hours after activation of the easyRESCUE-PRO³ or until the device is deactivated.

4 Functions

4.1 Device overview

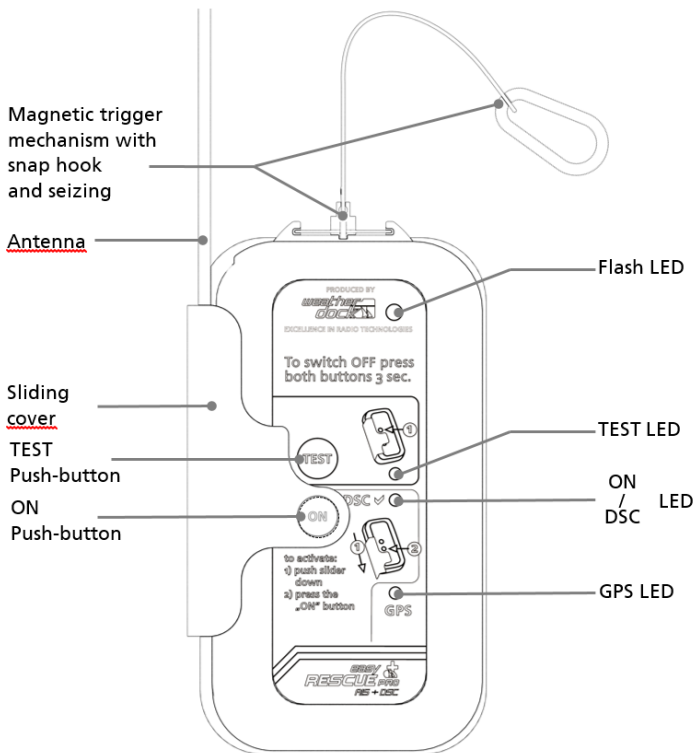

4.2 LED Elements

4.2.1 LED „FLASH“



The white LED flashes when the Rescue Transmitter being activated (ON or TEST mode). This powerful LED assists in finding the person in distress in darkness or bad weather conditions.

4.2.2 LED „TEST“

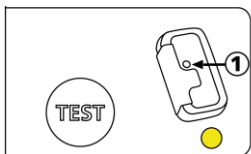

The yellow LED "TEST" blinks when the Rescue Transmitter is in TEST mode.

At the end of TEST mode, it indicates – together with LED „GPS“ – the Test result.

4.2.3 LED „ON“ / „DSC“

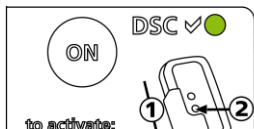

The green LED blinks to visualize the activated ON mode (in Rescue Transmitters those without DSC functionality).

(Only applies to devices of the easyRESCUE-PROI-PRO³ series)

In those devices with DSC function, the green DSC LED is usually off during operation and only blinks when the Rescue Transmitter receives a DSC confirmation.

This may be possible in 2 cases:

- 1) The Rescue Transmitter receives a DSC confirmation from a ship or a coast control center during the DSC distress call functionality. It continues to blink until the Rescue Transmitter is switched off or if the battery is too low.
- 2) The Rescue Transmitters receives a DSC confirmation during a function test.

4.2.4 LED „GPS“

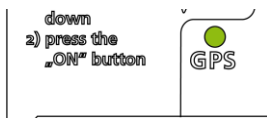

LED “GPS” blinks green when receiving GPS signals and if a position can be determined. If GPS reception is not possible, the LED is stays off.

At the end of TEST mode, it indicates – together with LED „TEST” – the Test result.

4.3 Sliding Cover

The sliding cover prevents accidental triggering.

The following picture shows the different versions of the slider.



Standard

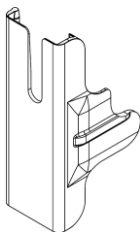

Universal

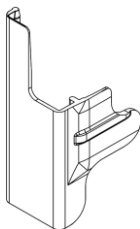

Universal LV

Universal/Universal LV

The "ON" button can be uncovered by pushing the slider down. The seal label, which serves as an indicator for a manual release, will break by doing this. The TEST button can be accessed at any time.

Standard

(Only applies to devices of the easyRESCUE A040, A040-BW series)

By pulling down the slide, the "TEST" button can be released, by pressing the slide strongly upwards, the "ON" button can be released. The red plastic seal, which serves as an indicator for a manual release, will break by doing this.

4.4 ON Mode (Alert)

4.4.1 Overview Sent Signals

	Ao40	Ao49	Ao40-BW-COM	Ao40-PRO	Ao4003-PRO ³
AIS	✓	✓	✓	✓	✓
DSC	x	x	x	✓	✓
Homing (121,5 MHz)	x	x	x	x	✓

4.4.1.1 AIS Emergency Signal

After activation, the upper Flash LED starts blinking at an interval and the Rescue Transmitter starts sending AIS emergency signals. (See chapter 3.1)

4.4.1.2 DSC Alert

(Only applies to devices of the easyRESCUE-PRO/PRO³ series)

DSC alarming is initiated simultaneously. (See chapter 3.2)

4.4.1.3 Homing Signal (121.5 MHz)

(Only applies to devices of the easyRESCUE-PRO³ series)

In addition, a 121.5 MHz reference signal will be transmitted permanently for 6 hours after the first minute. (See chapter 3.3)

4.4.2 Overview Triggering Functions

	A040	A049	A040- BW-COM	A040- PRO	A04003- PRO ³
Manual activation	✓	✓	✓	✓	✓
Water activation	x	✓	✓	✓	✓
Magnet activation	x	x	✓	✓	✓

4.4.2.1 Manual Activation

By pushing the slider down, the button "ON" is exposed and can be activated.

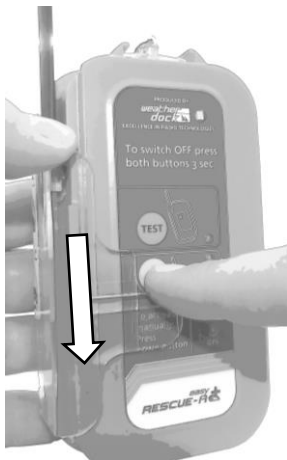

4.4.2.2 Activation via Water Contact

(Does not apply for asyRESCUE-Ao40, easyRESCUE-Ao40-ATEX, easyRESCUE-Ao49, easyRESCUE-Ao49-ATEX)

If the device is submerged for more than one second, it activates automatically. In this case, a water contact between the antenna axis and the back panel screw is recognized. The spatial separation of the two measuring contacts ensures that the device is not triggered by gushing water.

- ⚠ Keep all screws on the back panel free from any stickers and dirt. They are crucial for the automatic activation by water contact.

4.4.2.3 Activation through Magnetic Switch

(Only applies to devices of the Ao40-BW-COM, Ao40-PRO and Ao4003 series)

The Rescue Transmitters with a magnetic switch activation function are designed for the use with an automatic life vest. If the automatic life vest inflates, the Rescue Transmitter is activated.

In order to being able to integrate the Rescue Transmitter into the life vest, it must have a pocket for this purpose (specification by manufacturers of life vests). Please visit our website to find information which vests are available for the easyRESCUE.

(<https://www.easyais.com/en/lifejackets/>)

4.4.3 Deactivation

By pressing the two buttons simultaneously for more than 3 seconds, the ON Mode and therefore the Rescue Transmitter can be switched off. For quitting TEST mode, press button TEST for more than 3 seconds.

Otherwise the Rescue Transmitter continues to operate until the battery is flat. (In test mode, the device switches off automatically. See chapter 4.5)

(Only applies to devices with magnetic triggering:

A fast blinking TEST LED indicates that the Rescue Transmitter is switched off and that the magnetic release was not triggered. In this case sending emergency signals stops. By inserting the magnet, the flashing of the LED stops and the device switches off automatically.)

General rule:

The device must be serviced by an authorized service center after activation.

4.5 TEST Mode

A function test can be carried out 30 times within the period of five years until the battery needs to be replaced as stipulated by SOLAS. This does not impair the operation of 96 hours (AIS operation) or 24 hours (AIS & DSC operation) in the event of an activation.

Please proceed as follows to perform a function test:

- 1) Make sure to have a clear view to the sky in order to have a flawless GPS reception.
- 2) Press the "TEST" button.
- 3) All four LEDs will light up for 1 second to indicate that the TEST mode has started. Following that, the TEST and FLASH LED start blinking by turns.
- 4) As soon as a GPS position has been received, the GPS LED starts blinking as well. The Rescue Transmitter will then send an AIS telegram bundle with the GPS position and the message "SART TEST".

If the device does not receive a GPS position, the Rescue Transmitter sends an AIS telegram bundle without position after 5 minutes.

- 5) With an AIS receiver you can check the transmission of test telegrams by the Rescue Transmitter. The Rescue Transmitter appears as a circle on the display. In older systems it appears at least as a ship icon. The 9-digit "Unit ID" (MMSI) beginning with "970" and the safety message (SRM) "SART TEST" are displayed. Depending on the display device, an acoustic and / or visual signal will be triggered.
- 6) At the end of the self-test, before the device switches off, the GPS and TEST LEDs will show the test result for 4 seconds:

GPS LED	Test LED	GPS	Battery
—	—	✓	✓
—	----	✓	X
----	—	X	✓
----	----	X	X

—	LED lights up
----	LED flashes
✓	OK
X	Contact Service

7) After completion of the test, the device switches off automatically.

easyRESCUE-PRO, easyRESCUE-PRO³:

In addition to the AIS telegrams, two DSC telegrams are sent to the programmed MMSI numbers.

One of them, immediately after turning it on without any position information, another one after obtaining the GPS fix with position information.

easyRESCUE-PRO³:

In addition to AIS and DSC telegrams, the homing signal is transmitted for 10 seconds (or until the DSC test signal is acknowledged).

You can terminate the TEST mode early by pressing the TEST button (> 3 seconds).

If the test result is not correct, the device must be serviced by an authorized service center.

Make sure that the Rescue Transmitter has a clear view to the sky. If the Rescue Transmitter does not receive a GPS signal repeatedly, the device must be serviced by an authorized service center.

5 Installation Details

5.1 Life Vest

(Only applies to devices of A040-BW-COM an, A040-PRO and A04003 series)

For the installation of an easyRESCUE Rescue Transmitter, your life vest needs to have a special pocket.

For vests of the company *Secumar* you need a *A040-BW-COM/A040-PRO/A04003* device; a *(LV)* device, for any other life vest manufacturers. The devices only differ with regard to the cover slide (see chapter 4.3).

5.2 Accessories

5.2.1 Belt clip

(Accessories: only for the devices A040 and A049)

With the belt clip you can easily attach the Rescue Transmitter to a belt on your body or to a buoyancy foam jacket, for example.

A cord which is rolled up in a holder is connected to the device so that the Rescue Transmitter cannot go adrift when it is removed from the bracket.

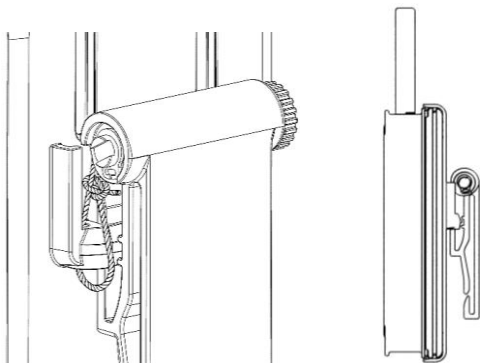

5.2.2 Telescopic Rod

(Available as separate accessory)

With the telescopic rod you can bring the Rescue Transmitter to more than 1 meter above sea level if the life boat does not have higher superstructures for mounting the bracket.

The bracket incl. Rescue Transmitter and telescopic rod are buoyant.

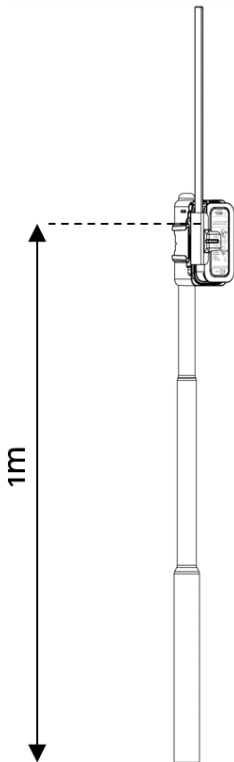

5.2.3 Attachment to Life Raft

By means of the telescopic rod, belt clip or neoprene bag, the device can be fixed in an elevated position to a life raft or life boat.

(Antenna nadir > 1 m above the water is recommended)

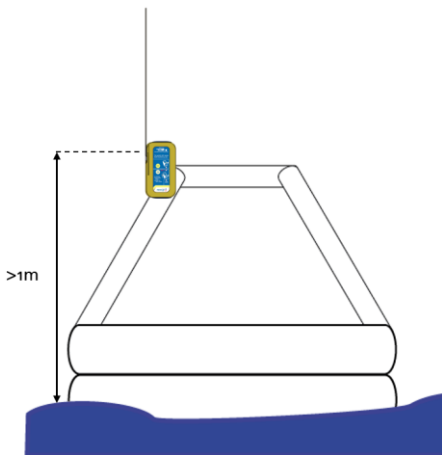

5.2.4 Neoprene bag

(Available as separate accessory)

The neoprene bag (suitable for attaching it to the arm, a life raft or mast) is available under item number Bo66.

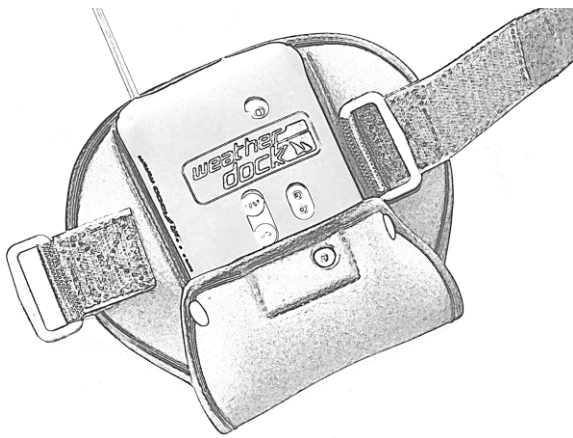

6 Programming of the MMSI for DSC Alerts

(Only applies to devices of the easyRESCUE-PROI-PRO³ series)

Within the 5 years, as specified by SOLAS, until the next replacement of batteries becomes necessary, a total of 30 minutes is scheduled for the programming. This does not impair the operation of 96 hours (AIS operation) or 24 hours (AIS & DSC operation) in the event of an activation.

In order for the easyRESCUE-PROI-PRO³ to be able to send a "distress call" to your own boat it is necessary to program the MMSI of the DSC radio device of the mother ship (for "closed loop"). In this way, the Rescue Transmitter and the DSC radio device on board of the mother ship are paired as a 2-way DSC communication unit according to GMDSS.

For users who are regularly on different ships, the MMSI numbers of up to 8 different mother ships can be programmed into the memory of the Rescue Transmitter. They will be alerted in the "closed loop".

There are 3 different ways to program an MMSI:

1) via Bluetooth® connection to an iPhone®, iPad®, Android® smartphone or tablet by using the Weatherdock programming application "easyRESCUE-PRO"

(Only applies to the easyRESCUE-PRO(BT & BT-LV), easyRESCUE-PRO³ series)

- 2) via direct DSC "individual call" from the DSC radio device of the mother ship,
- 3) with the programming station (easyPROGRAMMER, A124) on a PC via USB connection.

6.1 Programming via App

(Only applies to devices of the easyRESCUE-PRO(BT & BT-LV), easyRESCUE-PRO³ series)

This can be done via BLUETOOTH® connection with your smartphone or tablet by using the Weatherdock application "easyRESCUE", which can be downloaded for free on Google Play® or in the Apple® App Store®.

- 1) Download the corresponding application for your mobile device.
- 2) Activate the BLUETOOTH® function on your smartphone or tablet.

- 3) Press the "TEST" button of the Rescue Transmitter for more than 3 seconds until a triple beep is heard. Thereby all 4 LEDs light up.

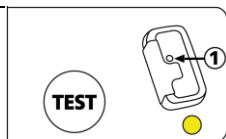

- 4) The Rescue Transmitter is now in programming mode. All the other LEDs, except for the yellow "TEST" LED go off. If

there is no communication between the devices, the Rescue Transmitter switches off after 3 minutes.

- 5) Open the app.
- 6) Tap "Search easyRESCUE-PRO" to connect the app with the Rescue Transmitter.

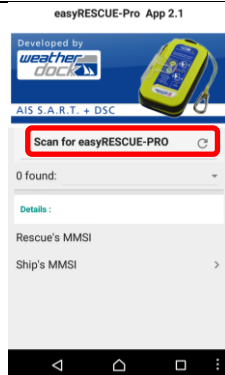

- 7) With a short glance on the rear side of the Rescue Transmitter you will find a type label to check whether the "Rescue's MMSI" in the app corresponds with the one on the device.

- 8) At "Ship's MMSI", tap onto the arrow pointing to the right.

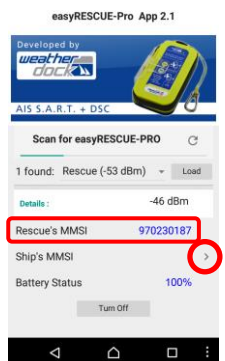

- 9) A window will pop up.
- 10) Tap any of the 8 fields to enter an MMSI number.

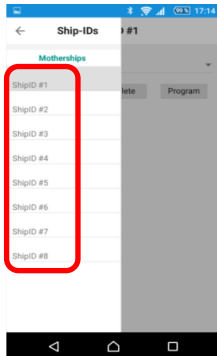

- 11) Now type the desired MMSI.
- 12) Then tap "Program".

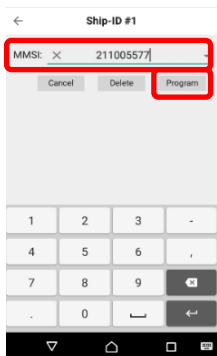

- 13) The entered MMSI is now stored in the internal memory of the Rescue Transmitter. In this example "Ship ID #1"
- 14) The Rescue Transmitter confirms the correct input and storage of the MMSI with a beep tone.
- 15) This process can be repeated until all 8 memory spaces are filled in.

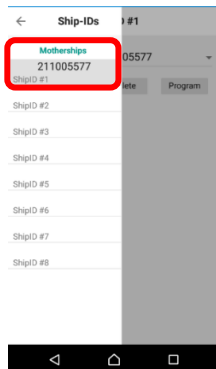

- 16) To delete a MMSI from the memory of the Rescue Transmitter, tap on the respective number and then tap "Delete".

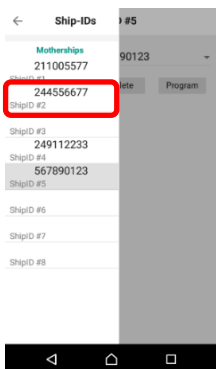

- 17) Tap the small arrow pointing to the left to exit the programming window.
- 18) By tapping on "Turn Off" the Rescue Transmitter is switched off. This is also accompanied by a beep.
- 19) If the Rescue Transmitter is not switched off manually, it switches off automatically after 3 minutes without any activity.
- 20) The Rescue Transmitter is now configured.

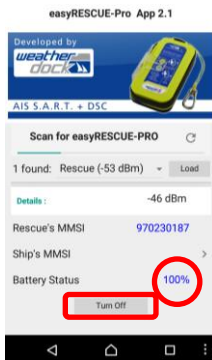

6.2 Programming via DSC „Individual Call“

- 1) Go to the “Individual Call” settings of your VHF radio and key in the Rescue Transmitter’s Unit-ID (MMSI).
- 2) Press the “TEST” button of the Rescue Transmitter for more than 3 seconds until a triple beep is heard. Thereby all 4 LEDs light up. 
- 3) The Rescue Transmitter is now in programming mode. All the other LEDs, except for the yellow “TEST” LED, go off. If there is no communication between the devices, the Rescue Transmitter switches off after 3 minutes.
- 4) Perform an “Individual Call” to the Unit ID (MMSI) of the Rescue Transmitter.
- 5) The Rescue Transmitter responds automatically and sends a confirmation to the predetermined MMSI of the mother ship. You will hear 5 beeps and the Rescue Transmitter switches off automatically.
- 6) In most cases the confirmation of the Rescue Transmitter also triggers an acoustic signal on the DSC radio device.

This way of MMSI programming can be performed up to 8 times in order to program up to 8 different MMSI (with 8 different radio devices) into the internal memory.

- ⚠ The stored MMSI numbers cannot be changed or deleted by means of the radio device.

When attempting to program a 9th number into the Rescue Transmitter, there will be a warning with a quick successive beep tone and the yellow "TEST" LED blinks quickly. For safety reasons you must confirm this warning by pressing the "TEST" button.

Change or deleting of MMSI numbers is only possible via App or Programming station.

6.3 Programming via Programming Station

(Available as separate accessory)

The Programming Station accesses the electronics of the Rescue Transmitter via the back panel contacts.

By means of the programming software installed on a PC, all of the 8 possible MMSI numbers can be edited individually (creating, editing, and deleting).



7 Technical specification

7.1 AIS SART

Description	Value
Case Measurements	(L) 130mm * (W) 70mm * (H) 30mm
Total Weight	250 - 350 grams (depending on variant)
Battery	Industrial pack 4 Lithium Cells (CR17345) à 3V
Frequencies	AIS 1: 161.975 MHz AIS 2: 162.025 MHz
Transmission Power	2 Watt (radiated)
GPS Receiver	50 Channel Receiver with integrated antenna, admitted according to IEC 61108-1
VHF Antenna	Fold-out, vertically polarized
Operation Time (activated)	Up to 96 hours at -20°C
Battery Life	≥ 5 years
Operating Temperature Range	-20°C to +55°C
Storage Temperature Range	-30°C to +70°C
Display	3 colored LEDs 1 white flash LED
Controls	2 buttons; 1 magnetic switch (device-dependent)

**Supported AIS
Notifications in
Transmitting Operation**

Msg.1:

**AIS position report (dynamic data)
are sent**

- **6 -8 times per minute**
- **Unit ID: 9-digit identification
number
(unique in the world)**
- **Speed over Ground (SOG)**
- **Course over Ground (COG)**
- **GPS position**

Msg.14:

AIS Safety Message is sent

- **2 times every 4 minutes**
- **Unit-ID**
- **Text: "SART ACTIVE" upon
activation in an emergency**
- **Text: "SART TEST" in test
mode**

Complied Standards

**IEC 61097-14, IEC 60945, ITU-RM.1371-
5, IMO Res. MSC.246(83), IEC 61108-1**

7.2 DSC MOB (supplemental to 7.1)

(Only for devices of the easyRESCUE-PROI-PRO³ series)

Description	Value
DSC operation	"Closed loop" and "open loop" pursuant to RTCM 11901.1
Frequencies	DSC Frequency: 156.525 MHz
Transmission Power	0.5 Watt
Operation Time (activated)	In common operation of AIS & DSC: up to 24 hours
Battery Life	≥ 5 years

7.3 HOMING (supplemental to 7.1)

(Only for devices of the easyRESCUE-PRO³ series)

Description	Value
Frequencies	121,5 MHz
Transmission Power	0.05 Watt
Operation Time (activated)	In common operation of AIS, DSC & HOMING: up to 24 hours
Battery Life	≥ 5 years

8 Troubleshooting

Problem	Cause	Solution
“TEST” LED is blinking but the “GPS” LED has not started blinking even after 5 minutes.	No GPS reception	The easyRESCUE needs a GPS signal to perform the test, which may be difficult to receive in some circumstances. Therefore, it would be best to perform the test outdoors. If the same error occurs again, please return the device to your distributor.
The device cannot be turned on.	Battery is too low	The battery pack is designed for 5 years’ lifetime with several function tests (up to 30 tests). After this time the device must be returned to the distributor to have the battery pack replaced. Only the distributor is entitled to do this!

Problem	Cause	Solution
The Rescue Transmitter is not displayed on the plotter	Old firmware of the plotter	Older plotters or those with old firmware may in some cases interpret the AIS SART messages incorrectly. Please contact the manufacturer of your plotter.
The Rescue Transmitter is not received by my own system	Overdriving of the receiver	The Rescue Transmitter is located too close to the receiver. Try to observe a distance of > 20 m from the receiver or wind the antenna of the Rescue Transmitter around the housing. This minimizes the radiated power.

9 Maintenance

The following maintenance and / or inspection is required for the Rescue Transmitters of the easyRESCUE series.

The device should be activated in test mode by pressing the "TEST" button after 6 months, however under no circumstances later than after 12 months.

The battery must be replaced after 5 years (SOLAS requirement).

You can find the exact expiration date on the label on the back panel of the device.

Such a replacement shall only be done by your distributor.

10 Contact and Product Support

Even though Weatherdock AG always strives to edit all publications with the highest level of accuracy, this manual may contain errors or ambiguities. In addition, the incumbent changes to the manuals are at the sole discretion of the company Weatherdock and may be made without giving prior notice.

Contact:

Weatherdock AG
Emmericher Strasse 17
90411 Nürnberg
Tel: +49 911-37 66 38 30
support@weatherdock.de

11 easyRESCUE – Database

In order to make the Rescue Transmitter even more safe and more effective, we provide a database on our website where personal and relevant data can be stored.

By providing this information you enable the official first responders, such as DGzRS, to act effectively and quickly in case of an emergency. You can provide the following information:

- Name
- Address (email, phone number)
- Date of birth
- Please inform in case of emergency
- Special information (chronic diseases, allergies, etc.)
- Ship name
- Ship type (motor yacht / sailing yacht)
- Call sign of the ship
- MMSI of the ship
- Charter (yes / no)
- If charter: Charter company and country

All this information is voluntary. Your data is stored encrypted on our German server and can only be viewed by accredited rescue organizations when entering the Unit ID of the Rescue Transmitter.

12 License Agreement

By using the easyRESCUE you agree to the terms of the following warranty provisions. please read these provisions thoroughly.

Weatherdock AG grants a limited license for the use of the device under normal operation conditions of the product. Title, proprietary rights and intellectual property rights in and to the software shall remain with Weatherdock AG.

13 Warranty

Weatherdock AG grants a warranty period of 2 years from the date of purchase for this product on material and manufacturing defects. Weatherdock AG will, at its own discretion and after normal use, repair and replace defective components within this period. Repair or replacement will be made free of charge for parts or labor. The customer, however, shall bear the shipping costs. This warranty shall not be granted in case of abuse, misuse, accidents or changes or repair which is not permitted.

The included warranty and rights are exclusive and are in lieu of any other express or implied warranty or laws, including any statutory or other liability arising from a warranty of profitability or fitness for a particular purpose. This warranty grants you specific rights depending on your country. In no case shall Weatherdock AG be held responsible for incidental, special, indirect or consequential damages arising from the use or potential disuse of the product or from defects of the

product. Weatherdock AG reserves the sole right to repair or replace the device or software or to refund the purchase price. This right is your only and exclusive right in a warranty case. Products which have been acquired in online auctions do not entitle you to rebates or to the use of special offers of Weatherdock AG. Furthermore, receipts from online auctions are not accepted as proof of entitlement to warranty claims. In order to satisfy warranty claims, the original receipt of your distributor is always required. Weatherdock AG will not replace any parts of the device or accessories of products which were purchased in online auctions. Please contact your Weatherdock AG distributor in case of a warranty claim. They will coordinate the next steps with you. Package the device carefully in case of a shipment and send it to the address provided by your distributor, with sufficient postage. Always enclose a copy of the original receipt in warranty repair as proof of ownership. The Weatherdock AG easyRESCUE does not contain parts which require repair by the user. Please contact your easyRESCUE distributor if you have a problem with the device. Any attempt to open, change and modify the device will void the warranty claims and may cause irreparable damage to the device. Opening through an unauthorized person will result in an invalidation of your warranty. Please contact your authorized distributor.

CAUTION:

It is the user's sole responsibility to use the Rescue Transmitter carefully. By triggering an AIS distress signal you will call the surrounding ships and / or coastal radio stations within AIS reach and inform them about your distress situation and position.

The easyRESCUE-PRO can send an official distress call to a distant rescue service (e.g. DGzRS) via its DSC function. This is not a minor offense!

All trademarks used in this document are the property of the respective companies.

Copyright © 2017 Weatherdock AG.

Copying and passing on these documents as well as the utilization and disclosure of their content is not permitted, unless expressly admitted. Any violation of the aforementioned will make you liable to pay damages.

14 Notes

INDEX

1

121.5 MHz19

121.5 MHz.14

A

Abbreviations6

Abstract.....10

Accessories.....26

Activation20, 21

AIS Emergency Signal19

AIS Function11

AIS-SART.....10

Alert19

App.....31

automatic life vest.....21

B

Bag29

Belt clip.....26

Bluetooth® connection ...30

C

Contact us44

D

Database45

Deactivation.....22

Device overview.....15

DSC Alert19

DSC Function.....12

H

Homing Function14

Homing Signal19

I

Installation25

L

LEDs16, 17

License Agreement46

Life raft.....28

Life Vest25

Login45

M

Magnetic Switch21

Maintenance43

Manual Activation20

N

Neoprene bag29

O

ON mode19

P

Programming of the MMSI
.....30, 31, 36, 37

S

Safety information7

Sliding Cover18

T

Technical specification... 38

Test mode22

Troubleshooting.....41

W

Warranty.....46

Water contact.....21



Weatherdock AG
Emmericher Strasse 17
D - 90411 Nürnberg
Tel.: +49 (0) 911 - 37663830
Fax: +49 (0) 911 - 37663840
www.easyais.com
info@weatherdock.de

easy
RESCUE 