



www.marine.vdo.com

OceanLink Master 4.3" TFT display

Operating instruction
v. 1.0



Contents

Introduction	3
Data pages	5
Data page configuration	7
System settings	10
Alarm management	13
Sensor configuration	17
MediaBox use	22
Troubleshooting	26
Technical specifications	27
Spare parts, sensors and accessories	28
Appendix	29

Customer service and warranty

In the event of malfunction, fault or for information on the warranty,
contact a VDO partner.

To find a partner, visit www.vdo-partner.com.

Introduction

Description

OceanLink Master 4.3" is a multifunction display that lets you monitor engine and connected sensor parameters. A display shows data from a single engine. The integrated NMEA2000 gateway lets you acquire engine data via analog signals or SAE J1939, to then convert and distribute them on NMEA2000 network. In addition to engine data, the display lets you set up to four analog sensors (multiple choice between trim, fuel level, rudder angle, fresh and waste water). All data are also distributed on EasyLink network to a maximum of 16 52mm OceanLink gauges.

NMEA 2000 connectivity lets you view navigation data from other devices on the network, such as wind, compass, GPS, speed and depth data. Following is an example of an application with two displays, one used as a gateway and the other as a NMEA 2000 monitor.

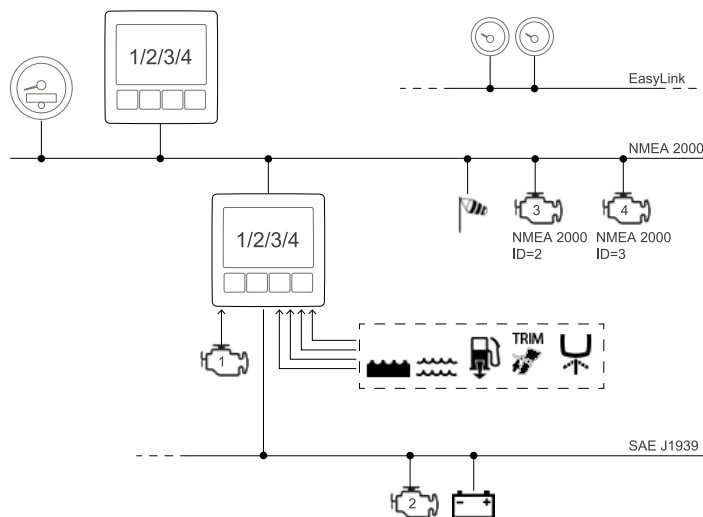

Operations

OceanLink Master 4.3" is a versatile device. It lets you monitor connected or other engine operations on the NMEA 2000 network in a single point.

Select the engine to be displayed when first turned on or when reset. Next, the displayed engine can be changed from the menu. Excluded engine data is never displayed.

Received signal priority

If the same data is available from more than one source, the received signal priority is the following:

1. Analog input
2. SAE J1939
3. NMEA 2000

On/Off

The on/off mode depends on the connection made during installation.

The VDO logo and software version appear when turned on followed by the last page viewed for more than 10 s before turned off.





The first time it is turned on, the display prompts you to select the ID (*instance number*) of the engine to be viewed (on SAE J1939 or on NMEA 2000). If the engine is connected via frequency input, this assignment determines engine ID transmitted on NMEA 2000.

Select the engine to be displayed

To view information on another engine:

1. Select **SYSTEM CONFIG > Display > Show data from engine nr.**
2. Or reset by selecting **SYSTEM CONFIG > Reset > Reset factory.**

Button functions

Button	Function
	Briefly press: <ul style="list-style-type: none"> • Open the menu • Return to the previous menu Hold down: <ul style="list-style-type: none"> • from any point to return to the data pages
 	Scroll pages/options
	Briefly press: <ul style="list-style-type: none"> • Open a sub-menu • Confirm the selection Hold down: <ul style="list-style-type: none"> • In the MediaBox page to save the selected station radio frequency

Data pages

What are data pages

Data pages display data received from the various sources. There can be up to 10 data pages. Four data pages and a MediaBox page are displayed by default. The **ALARMS** page appears after data pages if alarms are triggered.

Possible operations



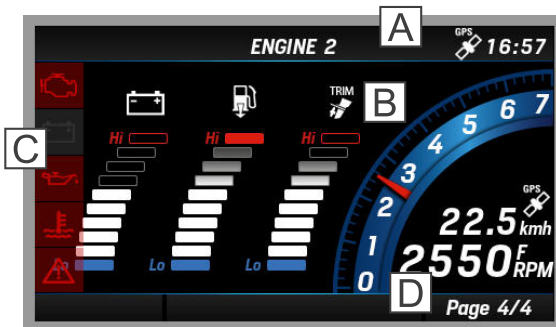

To scroll pages, press **▼** or **▲**. To add/delete/edit pages, see "Data page configuration" on page 7.



Shared features



Part	Description
A	Monitored engine ID. GPS signal and time (if available).
B	Data page content
C	Alarm bar. See "Alarm management" on page 13.
D	Data page progress bar

Managed data

Icon	Information	Input signal			Output signal		Unit of measure
		NMEA 2000	SAE J1939	Analog sensor	NMEA 2000	EasyLink	
	Engine rpm	x	x	x	x	-	rpm
	Trim	x	-	x	x	x	%
	Boost pressure	x	x	-	x	x	bar / psi / kPa
	Engine coolant temperature	x	x	-	x	x	°C / °F
	Battery voltage	x	x	x	x	x	V

Icon	Information	Input signal			Output signal		Unit of measure
		NMEA 2000	SAE J1939	Analog sensor	NMEA 2000	EasyLink	
	Fuel consumption	x	-	-	-	-	gal/h or l/h
	Engine oil temperature	x	x	-	x	x	°C / °F
	Engine oil pressure	x	x	-	x	x	bar / psi / kPa
	Total engine operating hours	x	x	x	x	-	h
	Rudder angle	x	-	x	x	x	°S (starboard) / °P (port)
	Depth below transducer*	x	-	-	-	-	m / ft
	Fuel level	x	x	x	x	x	%
	Fresh water level	x	-	x	x	x	%
	Waste water level	x	-	-	x	x	%
	Sea water temperature	x	-	-	-	-	°C / °F
	Course overground (COG)	x	-	-	-	-	°T (true North)
	Real course	x	-	-	x	-	°
AWA	Apparent wind angle (AWA)	x	-	-	x	-	°
	Apparent wind speed (AWS)	x	-	-	x	-	km/h
	Speed through water (STW)	x	-	-	-	-	mph / kn or km/h
	Speed overground (SOG)	x	-	-	-	-	mph / kn or km/h

Note*: the displayed value depends on any set offset. It is the depth below transducer by default (offset = 0).

Data page configuration

Configuration via layout

Each display page can be customized using the four editable layouts plus a default layout for MediaBox commands.

Layout description

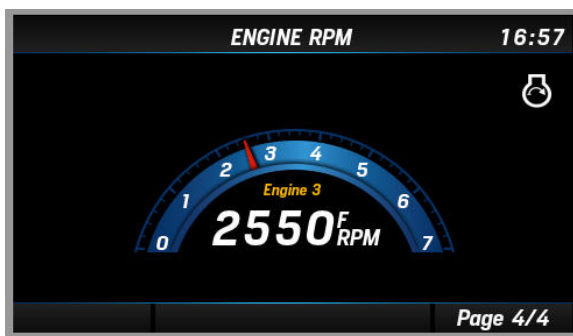

Layout **SINGLE**: single box. The data value is numeric or displayed by a gauge.

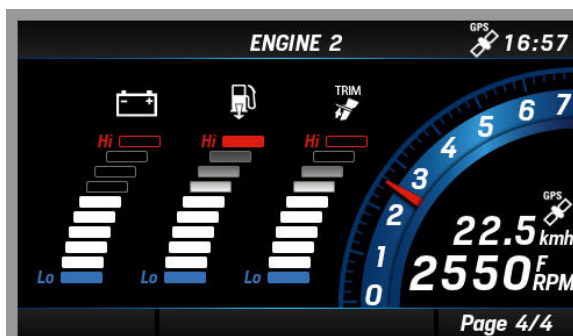

Layout **GRAPH**: with three bar graphs for the data selected from Boost pressure, Trim, Engine coolant temperature, Battery voltage, Fuel consumption. One engine revolution gauge and one for Speed over ground (SOG) not editable.

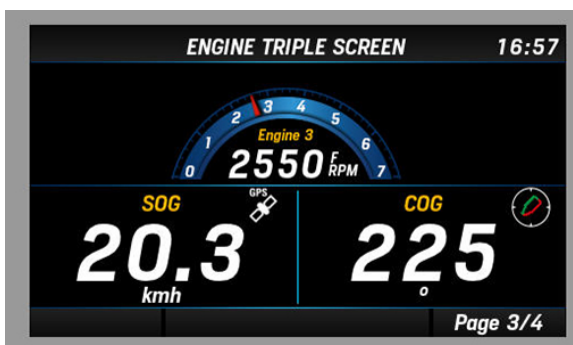

Layout **TRIPLE**: three boxes, from a minimum of three data to nine data.

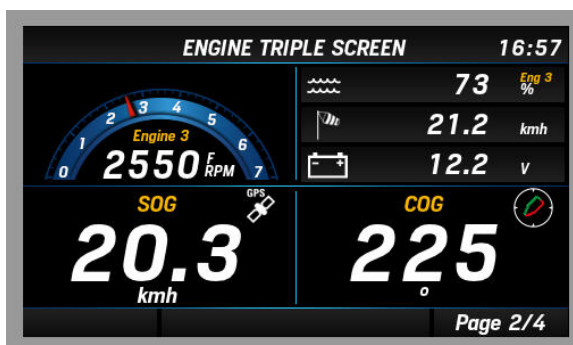

Layout **QUAD**: four boxes, from four to 16 data.



MediaBox page. See "MediaBox use" on page 22.

Add a page with three-box layout

Following is an example of how to add a page to view five data (two in single boxes and three in a triple box).

1. Press the **MENU** button and select **SCREEN CONFIG**.
2. Scroll until you see an empty page ("**NO SCREEN**") and select it.
3. Scroll and select the page layout **TRIPLE**: the layout opens with the first box green.
4. Press the **ENTER** button: the box layouts appear.
5. Select the layout **SINGLE**: the page layout reappears with the box red.
6. Scroll and select the required data: the box turns green.
7. Place the cursor on another box and repeat the procedure in step 4 selecting the box layout **TRIPLE**: the page layout reappears with the box divided in three sectors.
8. Select the sector to be set: the sector border turns red.
9. Scroll and select the required data: the sector border turns green.
10. Repeat the procedure from step 4 for the other box.
11. Hold down the **MENU** button to save settings and return to the data page.

Delete a page

How to delete a page:

1. Press the **MENU** button and select **SCREEN CONFIG**.
2. Scroll until you see the page to be deleted and select it.
3. Scroll and select page layout **REMOVE**: layout **REMOVE** appears in correspondence to the page.
4. Hold down the **MENU** button to save settings and return to the data page.

***Note:** the deleted page disappears. To add it again, see the example "Add a page with three-box layout" above.*

Apply a different layout to a page

How to edit a page layout:

1. Press the **MENU** button and select **SCREEN CONFIG**.
2. Scroll until you see the page to be edited and select it.

3. Scroll and select the new layout: the page opens.
4. Select the box layouts and data to be displayed.
5. Hold down the **MENU** button to save settings and return to the data page.

System settings

Menu layout SYSTEM CONFIG

*Note**: the units of measure depend on parameter **SYSTEM CONFIG > Units**

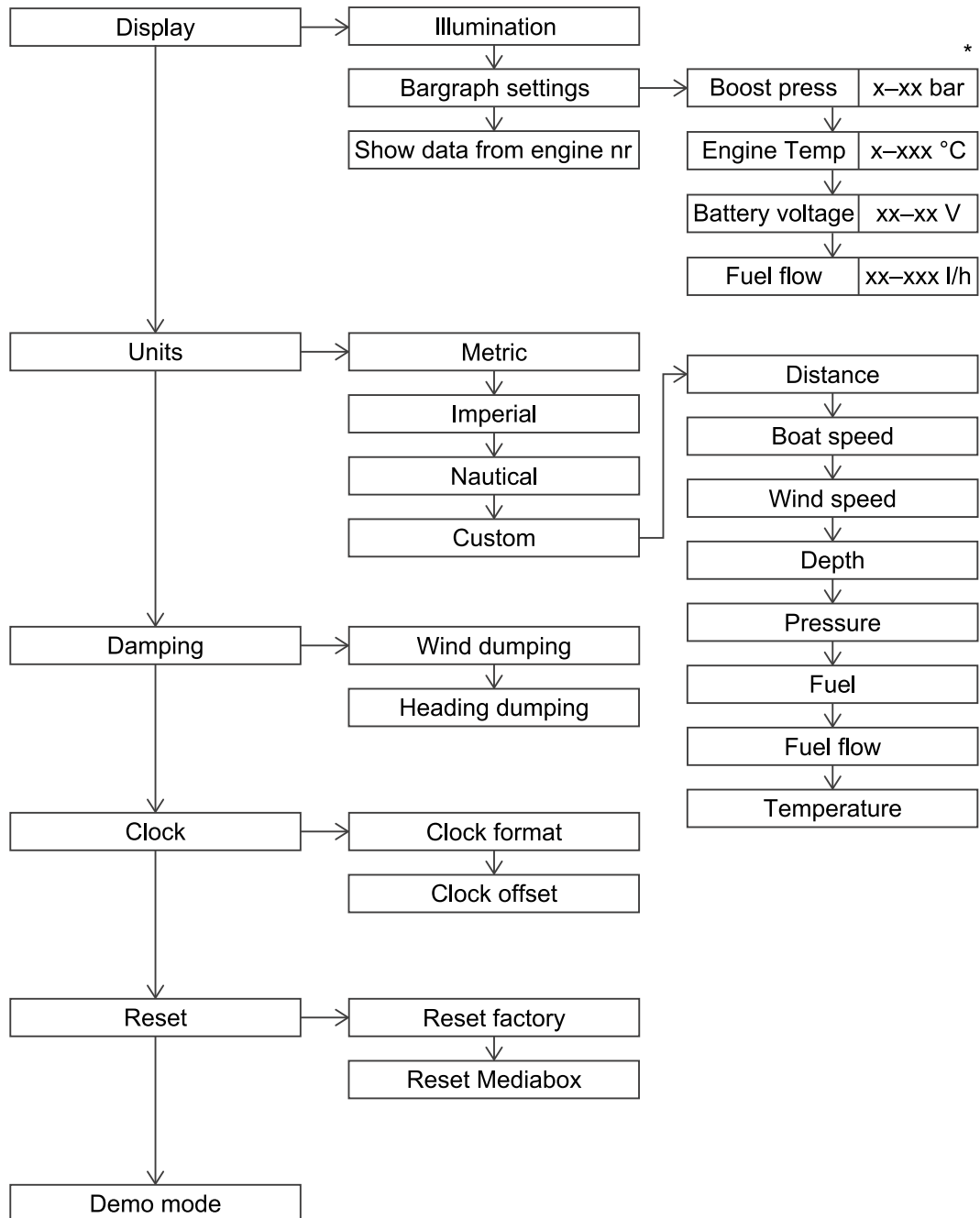

Configure the display

Following are the steps for initial configuration:

1. Connect any other sensors to analog inputs.
2. When turned on, indicate the engine ID to be monitored:

If...	Then....
the engine is connected to a frequency input	<ul style="list-style-type: none"> • assign an ID compatible with engines already on the network. To obtain the ID, increase the NMEA 2000 ID by one (i.e.: NMEA 0 ID =Engine 1, NMEA 1 ID =Engine 2 =, etc.). • Enable the sensor connected to the engine (Frequency input config = On in this menu).
the engine is already on the NMEA 2000/SAE J1939 network	select the engine on NMEA 2000 to view data considering that the original ID was increased by one (i.e.: Engine 1 =NMEA 0 ID, Engine 2 = NMEA 1 ID, etc.).

3. Set general OceanLink Master 4.3" operations (this menu)
4. Set the types of connected VDO sensors or calibrate third party sensors (see "Sensor configuration" on page 17).
5. Add/remove data pages selecting the best layout and data to be viewed (see "Data page configuration" on page 7).
6. If a page layout with bar graphs are used, customize the minimum and maximum intervals (**Bargraph settings** in this menu)
7. Enable/disable local input and NMEA 2000 and J1939 alarms (see "Alarm management" on page 13).

Menu description SYSTEM CONFIG

Note*: the underlined value/command is the default value/command. The units of measure depend on parameter **SYSTEM CONFIG > Units**

Setting	Description	Possible values/commands*
Display > Illumination	Display and connected 52 mm gauges brightness	<u>1</u> -7
Display > Bargraph settings	Bargraph interval (values Hi and Lo).	<ul style="list-style-type: none"> • Boost press: 0–14 bar (default = 0–1) • Engine temp 0–300 °C (default = 0–200) • Battery voltage 8–32 V (default = 10–16) • Fuel flow 0–800 l/h (default = 0–150)
Display > Show data from engine nr	Engine to be monitored. <i>Note: if the engine is already on the NMEA 2000/SAE J1939 network, the number displayed is increased by 1 from the original (i.e.: Engine 1=NMEA 0 ID, Engine 2= NMEA 1 ID, etc.).</i>	<u>ENGINE 1</u> / ENGINE 2/ ENGINE 3/ ENGINE 4

Setting	Description	Possible values/commands*
Display > Units	Units of measure for the values displayed.	<ul style="list-style-type: none"> • Metric • Imperial • Nautical • Custom: fully customizable See "Unit of measure" on the next page.
Damping > Wind damping/ Heading damping	Data damping, see "Damping" below	<ul style="list-style-type: none"> • No • Low • Medium • High
Clock > Clock format	Time format	<ul style="list-style-type: none"> • 12 h • <u>24 h</u>
Clock > Clock offset	Time zone	From -12 to +12 h (<u>0</u>)
Reset > Reset factory	Restore all settings including MediaBox to factory settings	<ul style="list-style-type: none"> • Yes • No
Reset > Reset MediaBox	Only restore MediaBox settings to factory settings	<ul style="list-style-type: none"> • Yes • No
Demo mode	Device operating simulation. <i>Note: simulation mode remains on even after the device is turned off.</i>	<ul style="list-style-type: none"> • On: the device displays random values. Data is also transmitted to connected 52 mm gauges. • Off: turn off simulation mode

Unit of measure

Managed units of measure are provided below:

Data	Metric	Imperial	Nautical
Distance	km	mi	nmi / ft
Boat speed	kmh	mph	kn
Wind speed	kmh	kn	kn
Depth	m	ft	ft
Pressure	bar	psi	psi
Fuel	l	gal	gal
Fuel flow	l/h	gph	gph
Temperature	°C	°F	°F

Damping

The function makes the displayed values more stable. It is available for wind and compass data.

Example

*With medium-strong wind, to prevent the wind speed value from quickly and suddenly changing, set damping to **High** or **Medium**. On the contrary, with slight or no wind, set **No** or **Low** for a reactive indication.*

Alarm management

Signal mode

The displayed alarms are read by the NMEA 2000/SAE J1939 network or are processed by the display based on the data received from the network or analog signals. Engine alarms concern all engines on the network.

When an alarm is triggered, the **ALARM** page appears and then disappears after the alarm is acknowledged. See "Acknowledge an alarm" on the next page.

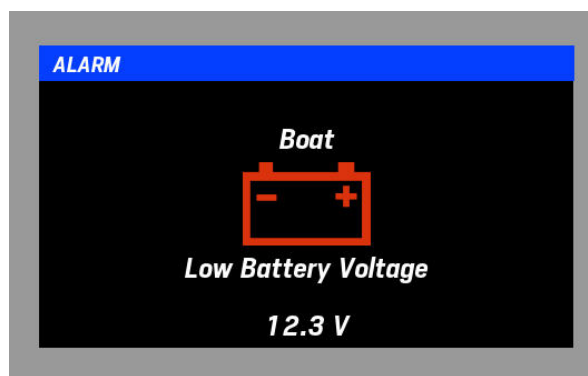



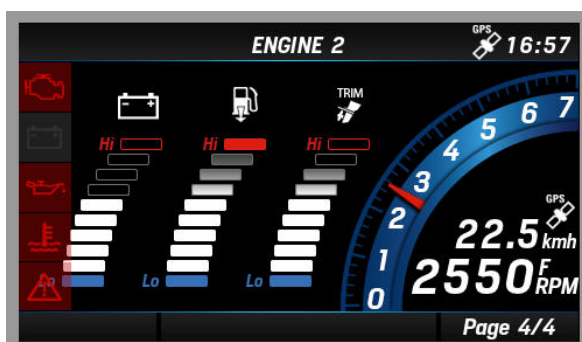

All active alarms appear in the **Active alarms** page that is added to the other data pages.

Note: an alarm set as disabled is ignored and will not appear in the alarm list. The alarm signal is inhibited during device configuration.

Signals on data pages



Red icon: alarm. See page **Active alarms**.

-  engine alarms
-  battery alarms
-  oil alarms
-  temperature alarms
-  generic alarms

Menu layout ALARMS

Note*: the units of measure depend on parameter **SYSTEM CONFIG > Units**

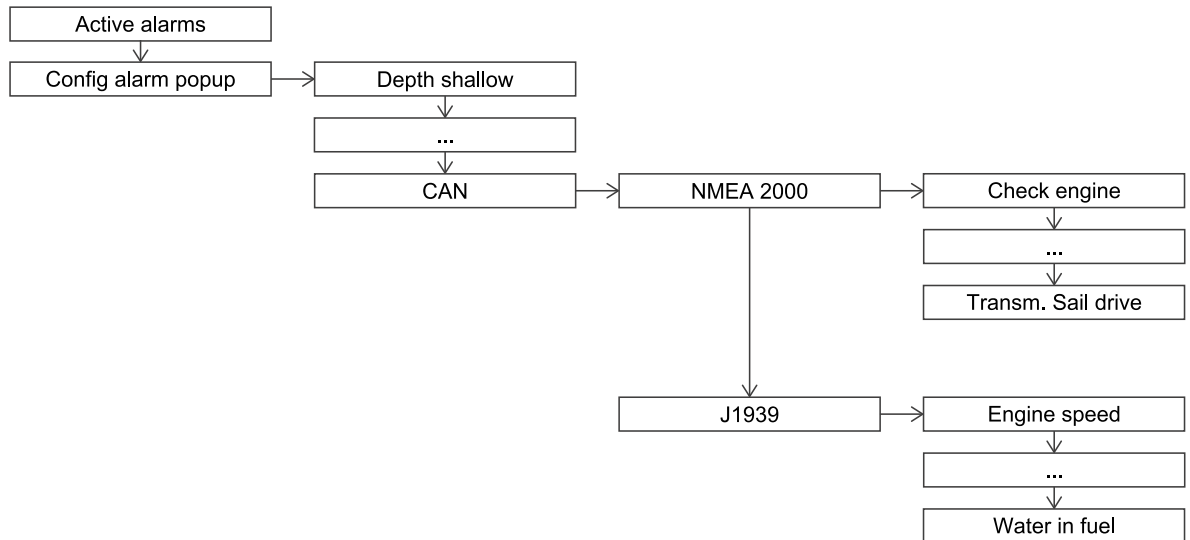

Acknowledge an alarm

When an alarm is triggered, the **ALARM** page appears and the buzzer sounds (if connected). What to do:

1. Press any button to acknowledge the alarm and mute the buzzer: the page closes and the alarm is saved on the **Active alarms** page.
2. If, after acknowledging the alarm, the same alarm reappears, the alarm bar appears in the data page and remains visible.

View the active alarm list

If at least one alarm is active, scroll the data pages or press the **MENU** button and select **ALARMS > Active alarms**: the **Active alarms** page appears.

Setting alarms from sensors 1

1. Press the **MENU** button and select **ALARMS > Config alarms popup**
2. Select one of the alarms from the sensors
3. Select **No** and select **Yes**: parameters appear
4. If necessary, select and edit the threshold(s) and enable/disable the buzzer.

Set alarms from NMEA2000/SAE J1939 network

1. Press the **MENU** button and select **ALARMS > Config alarms popup**
2. Select **CAN** and the network: the managed alarm list appears
3. Select one of the alarms from the network
4. If necessary, enable/disable the alarm signal in the **ALARM** window and enable/disable the buzzer.

Menu description ALARMS

Alarm	Description	Possible values/commands*	Default
Depth shallow	Low water minimum threshold	0–9.9 m	<u>2</u> m, buzzer Yes
Depth navigation	Maximum threshold. For example, a value near the maximum value measurable by the sensor. Safety depth minimum threshold	0 – 99.9 m 0 – 99.9 m	<u>50</u> m, buzzer No <u>5</u> m, buzzer No
Wind speed	Wind speed maximum threshold	0 – 99.9 km/h	<u>39.9</u> km/h, buzzer No
Battery voltage	Battery voltage minimum threshold	0 – 32.9 V	<u>10.8</u> V, buzzer Yes
Engine water temp	Water temperature maximum threshold	0 – 139 °C	<u>110</u> °C, buzzer Yes
Engine oil temp	Engine oil temperature maximum threshold	0 – 149 °C	<u>120</u> °C, buzzer Yes
Engine oil pressure	Engine oil pressure minimum threshold	0 – 99 bar	<u>0.5</u> bar, buzzer Yes
Fuel level	Fuel level minimum threshold	0 – 99 %	<u>20</u> %, buzzer Yes
Fresh water	Fresh water minimum threshold	0 – 99 % m	<u>20</u> %, buzzer Yes
Waste water	Waste water maximum threshold	0 – 99 %	<u>80</u> %, buzzer Yes
Min RPM	Engine revolutions minimum threshold. Only values under the threshold will be considered to trigger engine alarms.	0 – 999 rpm	<u>300</u> rpm
CAN	Alarm access from CAN bus (NMEA 2000 and J1939). See "Managed alarms list" on the next page	-	-

Managed alarms list

NMEA2000 - Engine Parameters, Dynamic (PGN 127489)

- Check engine
- Hot engine
- Low oil pres
- Low oil level
- Low fuel pres
- Low voltage
- Low cool level
- Water flow
- Water in fuel
- Charge indicat
- Preheat indic
- Boost pressure
- Over rev
- EGR system
- Main throttle
- Emergency stop
- General warn 1
- General warn 2
- Pwr reduction
- Maintenance
- Eng com error
- Sub throttle
- Neutral prot
- Eng shut down

NMEA2000 - Transmission Parameters, Dynamic (PGN 127493)

- Check gear
- Gear oil temp
- Gear oil pres
- Gear oil level
- Sail drive

SAE J1939 - Active Diagnostic Trouble Codes (DM1)

- Water in fuel indication
- Engine speed
- Engine Turbocharger boost pressure
- Exhaust gas temperature
- Engine oil pressure
- Engine Coolant Pressure
- Engine Coolant Temperature
- Engine oil temperature
- Transmission oil temperature
- Transmission oil pressure
- Fuel Level

Analog input

- Depth Shallow (low)
- Depth Navigation (low/high)
- Wind speed (high)
- Battery (low)
- Engine Water Temperature (high)
- Fuel level (low)
- Fresh water (low)
- Waste Water (high)
- Min RPM (by value)

Sensor configuration

Sensor-engine link

All values read by the sensors concerning engines are linked to the monitored engine before being converted and sent on the NMEA 2000 network. Only sensors connected to display analog inputs can be set and/or calibrated.

Two identical sensors

If there are two fuel level sensors, they cannot be connected to the two resistive inputs on the same display. The pin signal with higher ID (for example, pin 9) will always prevail over the pin signal with lower ID (pin 8).

Menu layout SENSOR CONFIG

Note*: the units of measure depend on parameter *SYSTEM CONFIG > Units*

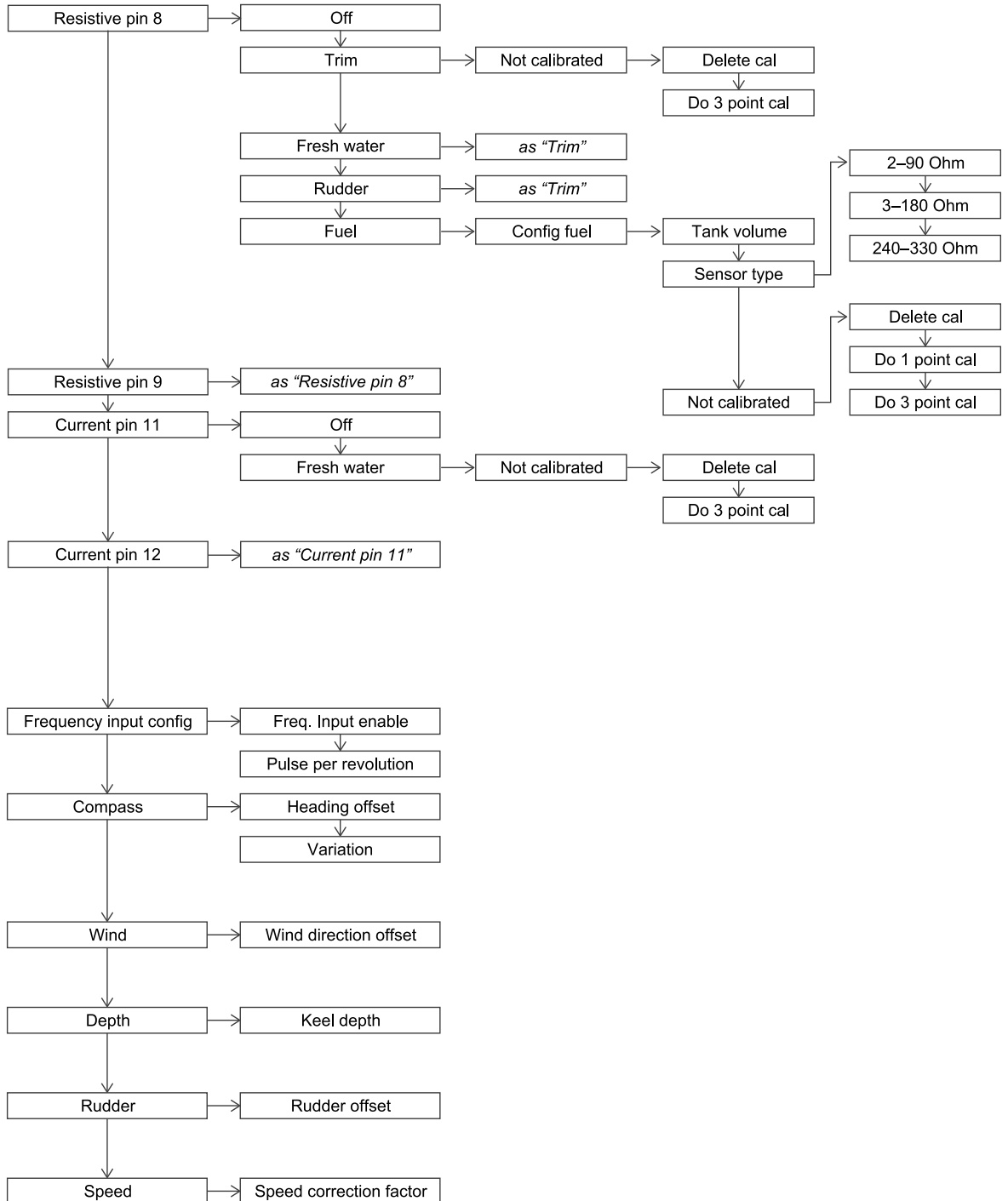

When to calibrate a sensor

VDO sensors do not require calibration. The display recognizes them and applies default values. Simply declare the type and the sensor starts reading the value with good approximation.

For third party sensors or for more accurate readings, calibrate the sensor. Calibration occurs with subsequent readings (at one, three or up to a maximum of five points) with a wizard.

Set a sensor without calibrating it

1. Press the **MENU** button and select **SENSOR CONFIG**.
2. Select the input: "Off" appears to indicate that no sensor is linked to the input or was disabled.
3. Select **Off**: sensor types appear
4. Select the sensor type: "Not calibrated" appears. The sensor is enabled but not manually calibrated. To view factory settings, see "Sensor types" on the next page.
5. If you do not want to calibrate, hold down the **MENU** button to return to the last viewed data page.

Set a sensor and calibrate it

1. Press the **MENU** button and select **SENSOR CONFIG**.
2. Select the input: "Off" appears to indicate that no sensor is linked to the input or was disabled.
3. Select **Off**: sensor types appear
4. Select the sensor type: "Not calibrated" appears. The sensor is enabled but not calibrated.
5. Select **Not calibrated**.
6. Select **Do 3 point cal** (for example): first reading calibration instructions appear. For tanks, they must be drained, wait until the value read stabilizes and confirm by pressing the **ENTER** button.
7. Proceed with all calibration points following the wizard.
8. Hold down the **MENU** button to return to the data pages.

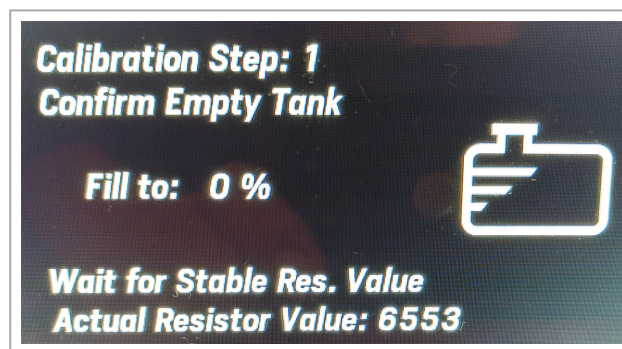

Delete a calibration

1. Press the **MENU** button and select **SENSOR CONFIG**.
2. Select the input linked to the sensor: the sensor type and calibration status appear.
3. Select the calibration status and select **Delete cal**: any manual calibrations are deleted and factory settings restored.
4. Hold down the **MENU** button to return to the data pages.

Sensor types

Note*: the underlined value/command is the default value/command. The units of measure depend on parameter **SYSTEM CONFIG > Units**

Setting	Description	Possible values/commands*
Resistive pin 8	Input 8 sensor	<ul style="list-style-type: none"> • <u>Off</u>: no connected analog sensor • Trim • Fresh water: fresh water level • Rudder: rudder angle • Fuel: fuel level. Sensor type: 2-90 Ohm/3-180 Ohm/240-330 Ohm
Resistive pin 9	Input 9 sensor	<ul style="list-style-type: none"> • Fuel: at one and at three points. Calibration for all others: at three points.
Current pin 11	Input 11 sensor	<ul style="list-style-type: none"> • <u>Off</u>: no connected analog sensor • Fresh water: fresh water level • Waste water: waste water level
Current pin 12	Input 12 sensor	Three point calibration.
Frequency input config	Impulses per engine revolution. If enabled, engine revolutions are read by the analog sensor in frequency. See "Calculate engine revolution impulses" below.	<u>Off</u> / On 0.0 – 655.32 (<u>1.0</u>)
Compass > Heading offset	Alignment between compass bow and boat bow.	±0.0 – 999 ° (<u>0</u> °)
Compass > Variation	Alignment between the magnetic North and true North.	±0.0 – 999 ° (<u>0</u> °)
Wind > Wind direction offset	Alignment between the wind sensor position and longitudinal boat axis.	±0 – 999 ° (<u>0</u> °)
Depth > Keel depth	Distance between the transducer and keel to calculate free water	0 – 9 m (<u>2</u> °)
Rudder > Rudder offset	Alignment between the sensor center and counter-rudder blade.	±0 – 999 ° (<u>0</u> °)
Speed > Speed correction factor	Alignment between the sensor Speed through water (STW) and real boat speed. See "Calculate the speed offset factor" below	0 – 199.99 ° (<u>1.00</u> °)

Calculate engine revolution impulses

The analog sensor connected to the engine sends signals in frequency (0-4kHz). Each impulse corresponds to one or more engine revolutions. In order to calculate rpm, set the impulse/engine revolution ratio.

Note: only as an example. Simply divide the number of cylinders by two in four-cylinder engines. For example, a four-cylinder engine sends two impulses per revolution.

Calculate the speed offset factor

The speed offset factor lets you align the displayed speed to the actual speed. The offset factor is helpful when navigating at low speed. In this case, the value displayed by the sensor is higher than the

real one since calculated with GPS ground references. The offset factor thus reduces the displayed speed data.

Example

If the displayed speed is 5 kn and actual speed is 6 kn, then the calculation to obtain the offset factor will be:

$$6/5 = 1.20$$

MediaBox use

Operations

MediaBox can be controlled by OceanLink Master 4.3" TFT display or the VDO MediaBox app available for Apple and Android devices in their stores. The app lets you remotely control MediaBox. It can control the following sources:

- FM stations
- AM stations
- playlists from USB key
- audio files from Bluetooth devices

Once connected to the NMEA 2000 network, MediaBox remains in stand-by, awaiting communications from the display or app.

On/Off

1. The "MediaBox not powered" message appears the first time the display is turned on: the display is connected to MediaBox but the media player is off.
2. Press the **ENTER** button: the main page appears with the **Power OFF** red symbol.

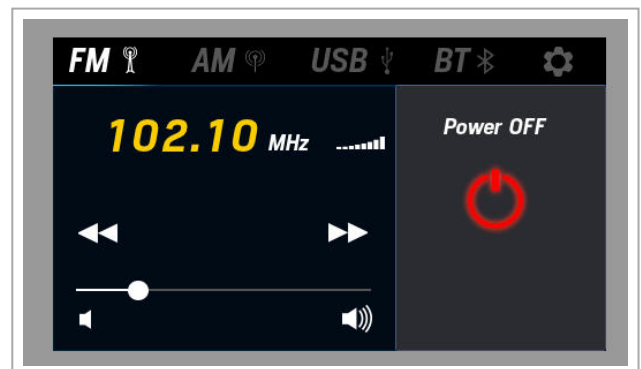

3. Press the **ENTER** button again: MediaBox turns on.
4. Press the **ENTER** button again: MediaBox turns off.

Note: if the USB and BT sources are not connected, their menus are disabled.

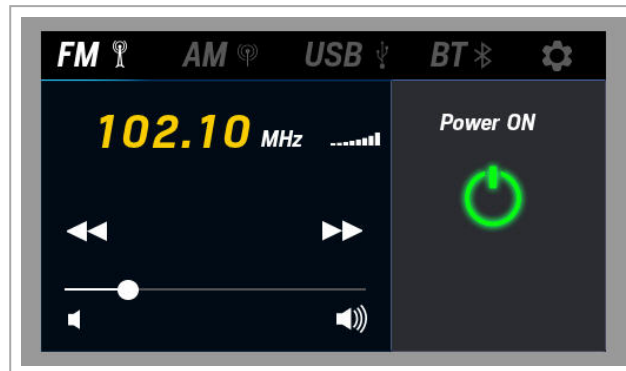

Listen/set FM stations

1. Repeatedly press the **MENU** button until positioned on the menu bar. Scroll and highlight the **FM** source.
2. Scroll and use the **ENTER** button to select the various commands or a saved station.
3. To set a station, once you have selected the frequency, move to a free station and hold down the **ENTER** button.

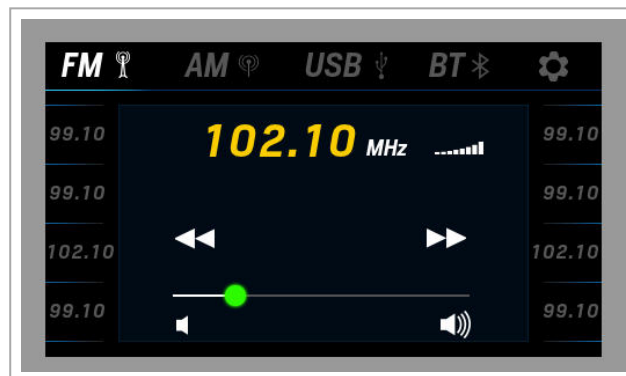

Listen/set AM stations

1. Repeatedly press the **MENU** button until positioned on the menu bar. Scroll and highlight the **AM** source.
2. Scroll and use the **ENTER** button to select the various commands or a saved station.
3. To set a station, once you have selected the frequency, move to a free station and hold down the **ENTER** button.

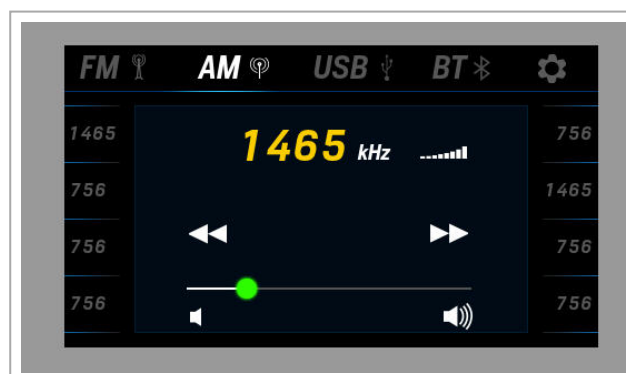

Listen to a playlist from USB key

1. Insert the USB key with the playlist.
2. Repeatedly press the **MENU** button until positioned on the menu bar. Scroll and highlight the **USB** source.
3. Scroll and use the **ENTER** button to select the various commands.
4. To select a track, select the playlist: the track list appears.

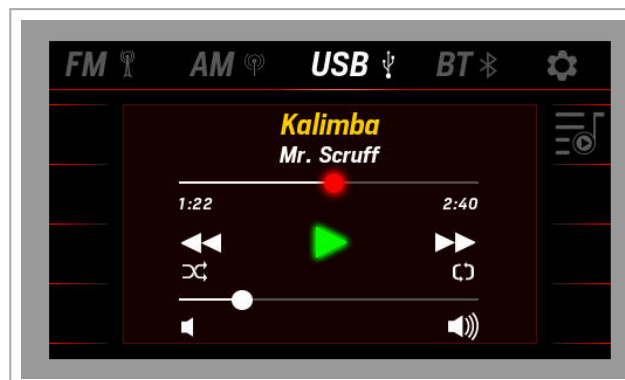

Listen to tracks from cell phone

1. Link MediaBox to a cell phone via Bluetooth.
2. Repeatedly press the **MENU** button until positioned on the menu bar. Scroll and highlight the **BT** source.
3. Scroll and use the **ENTER** button to select the various commands.

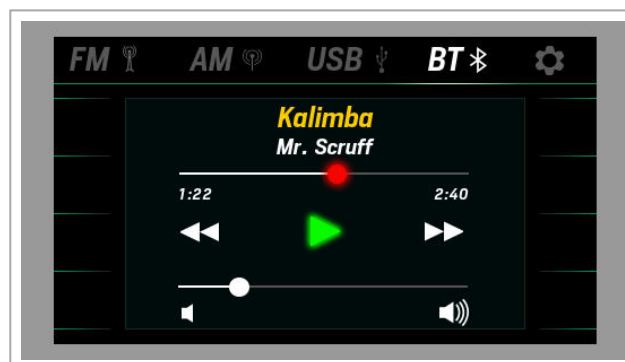

Set MediaBox operations

1. Repeatedly press the **MENU** button until positioned on the menu bar. Scroll and select **Settings** by pressing the **ENTER** button.
2. To adjust the volume, scroll and select **Equalizer**.
3. To obtain the correct frequencies for the geographical area, select **Tuner region**.
4. To obtain information on the media player, select **Info**.

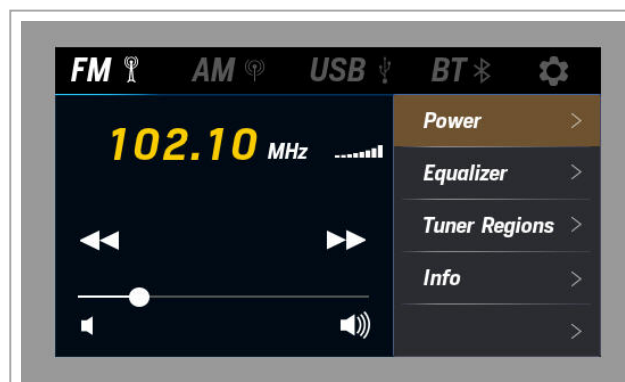

Add a MediaBox page

The page to control the media player is added after those already included.

1. Press the **MENU** button and select **SCREEN CONFIG**.
2. Scroll until you see an empty page ("**NO SCREEN**") and select it.
3. Scroll and select the page layout **RADIO**: the layout opens.
4. Repeatedly press the **MENU** button to exit the menu and save settings.

Reset MediaBox

To restore factory settings:

1. Press the **MENU** button and select **SYSTEM CONFIG**.
2. Select **Reset > Reset MediaBox**.

Troubleshooting

Display problems

Problem	Cause	Solution
The displayed values are not those expected	Incorrect sensor configuration	
	Incorrectly connected sensor	Check the connection, see installation instructions
	The NMEA 2000 network backbone was incorrectly created	Check connections and make sure there is a termination at the beginning and end of the backbone
"--" and not the expected value appears on the display	Data not available on the network	Wait
	Sensor not connected	Connect the sensor, see installation instructions
	The NMEA 2000 network backbone was incorrectly created	Check connections and make sure there is a termination at the beginning and end of the backbone
"Invalid value"	The sensor to be calibrated is faulty or disconnected	Check or replace the sensor
"No media player connected"	MediaBox is not connected to the NMEA 2000 network.	Check connections
"Media player not powered"	MediaBox is connected but off.	Turn on MediaBox, see "Introduction" on page 3.

Problems on connected 52 mm gauges

Problem	Cause	Solution
The gauge is backlit but the pointer does not move	Data not received from master	Check whether the 52 mm gauge is compatible with the master
The pointer does not move and the gauge is not backlit	Master not powered	Check master connections Connect the power supply
	No 52 mm chain gauge is connected to the master	Connect a 52 mm gauge to the master

Technical specifications

General features

Material	Aluminum and glass screen
Connectors	<ul style="list-style-type: none">• Molex MX150• NMEA 2000 Micro-C M12• EasyLink
Input data	<ul style="list-style-type: none">• via CAN bus (NMEA 2000 and SAE J1939)• 2 capacitive analog inputs (4-20 mA)• 2 resistive analog inputs (0–400 Ω)• 1 frequency input (0-4 kHz)
Output data	<ul style="list-style-type: none">• NMEA 2000• EasyLink (VDO proprietary protocol) to 52 mm gauges• output alarm (500 mA)
Protection grade	IPX6
Display	TFT 4.3"
52 mm gauges	Maximum 16

Environmental specifications

Working temperature	From -20 to +70 °C
Storage temperature	From -40 to +85 °C

Electrical specifications

Rated voltage	12 / 24 V
Voltage tolerance	8-28 V
Working current	< 300 mA @ 12 V
Absorption (LEN)	2

Conformity

Conformity	
Directives	2014/30/EU (Electromagnetic compatibility) 2011/65/EU (Electrical-electronic equipment hazardous substances)
Reference standards	IEC 60945: 2002-08 (environmental class: exposed)

Spare parts, sensors and accessories

Available spare parts

Product	Part number
Pigtail cable with MX150 connector	A2C15078700
White bezel	A2C11529800
Black bezel	A2C10832300
Sun cover	A2C99745000
EasyLine extension cable	A2C59500139

Available analog sensors

Data type	Sensor type	Part number
Trim (Trim)	10-167 Ω	-
Fresh water level (Fresh)	3-180 Ω	226-828-001-001K
Fuel level (Fuel)	3-180 Ω	226-801-015-001G, 226-801-015-001C, A2C59510162, A2C59510168
	240-33 Ω	A2C59510166, A2C59510172, A2C1364580001
Rudder angle (Rudder)	10-180 Ω	A2C1102950001
	5-90 Ω	A2C1102960001

Available accessories

To view available accessories, visit www.marine.vdo.com.

Appendix

Supported NMEA 2000 messages

PGN	Description
65030	J1939 Generator Average Basic AC Quantities
65226	J1939 Diagnostic Message #1
65227	J1939 Diagnostic Message #2
65228	J1939 Diagnostic Message #3
65229	J1939 Diagnostic Message #4
65230	J1939 Diagnostic Message #5
65231	J1939 Diagnostic Message #6
65232	J1939 Diagnostic Message #8
65234	J1939 Diagnostic Message #10
65235	J1939 Diagnostic Message #11
65236	J1939 Diagnostic Message #12
126992	System time
127245	Rudder
127250	Vessel heading
127251	Rate of Turn
127257	Attitude
127258	Temperature (Old Version)
127488	Engine Parameters, Rapid Update
127489	Engine Parameters, Dynamic
127498	Engine Parameters, Static
127505	Fluid level
127508	Battery status
128259	Speed: Water referenced
128267	Water depth
129025	Position: Rapid update
129026	COG and SOG: Rapid update
129029	GNSS position data
129033	Local Time Offset
129044	Datum

PGN	Description
129283	Cross track error
129284	Navigation data
129285	Navigation route and waypoint info
129539	GNSS dilution of precision (DOP)
129540	GNSS satellites in view
130306	Wind data
130310	Environmental parameters
130311	Environmental parameters
130312	Temperature
130313	Humidity
130314	Actual Pressure
130316	Temperature, Extended Range
130569	Entertainment - Current File and Status
130570	Entertainment - Library Data File
130571	Entertainment - Library Data Group
130572	Entertainment - Library Data Search
130573	Entertainment - Supported Source Data
130574	Entertainment - Supported Zone Data
130576	Small Craft Status
126992	System time
127488	Engine Parameters, Rapid Update
127489	Engine Parameters, Dynamic
127493	Transmission Parameters, Dynamic
127498	Engine Parameters, Static
127505	Fluid Level
127508	Battery Status
128267	Water Depth
130316	Temperature, Extended Range

Supported SAE J1939 messages

PGN	SPN	Description
61444	190	Engine Speed
61443	92	Engine Percent Load
61443	92	Engine Percent Load at Current Speed
61444	513	Actual Engine - Percent Torque
61445	523	Transmission Current Gear
65030	-	Generator Average Current
65030	-	Generator Average Frequency
65030	-	Generator Average Line to Neutral Voltage
65030	-	Generator Average Line to Line Voltage
65176	1180	Exhaust Temperature
65214	189	Engine Rated Speed
65242	234	Software Identification
65253	247	Engine Total Hours of Operation
65260	237	Vehicle Identification Number
65262	110	Engine Coolant Temperature
65262	175	Engine Oil Temperature 1

PGN	SPN	Description
65263	100	Engine Oil Pressure
65263	109	Engine Coolant Pressure
65263	94	Engine Fuel Delivery Pressure
65263	109	Engine Coolant Pressure
65265	-	Vehicle Speed
65266	184	Fuel Economy
65266	183	Engine Fuel Rate
65270	102	Engine Turbocharger Boost Pressure
65271	158	Battery Potential (Voltage), Switched
65271	167	Charging System Potential (Voltage)
65272	177	Transmission Oil Temperature
65272	127	Transmission Oil Pressure
65276	96	Fuel Consumption

Continental Automotive Switzerland AG

Industriestrasse 18

9464 Rüthi

Switzerland

www.marine.vdo.com

VDO – A Trademark of the Continental Corporation

Any distribution, translation or reproduction, partial or total, of the document is strictly prohibited unless with prior authorization in writing from Continental Automotive Switzerland AG, with the exception of the following actions:

- Printing the document in its original format, totally or partially.
- Copying contents without any modifications and stating Continental Automotive Switzerland AG as copyright owner.

Continental Automotive Switzerland AG reserves the right to make modifications or improvements to the relative documentation without notice.

Requests for authorization, additional copies of this manual or technical information on the latter, must be addressed to **Continental Automotive Switzerland AG**