

CORTEX

VHF | AIS | MONITOR

HANDSET INSTALLATION GUIDE

CORTEX-H1 - TETHERED HANDSET
CORTEX-H1P - PORTABLE HANDSET



vesper

Index

Introduction	3
DSC Emergency Calls	4
VHF Emergency Calls	5
Items you need for installation	6
Cradle & Bulkhead Connector wiring	7
Cradle position	8
To install a Cradle	9
H1 Bulkhead Connector	10
To install a Bulkhead Connector	11
To connect power to a handset	12
To place and remove a handset	12
Turning a handset ON	13
To connect a handset to an M1	14
Handset connection FAQs	15
To connect mobile devices to an M1	15
To program your MMSI number	16
To program your VHF (ATIS and Region)	17
Handset care	18
Handset use	18
Dimensions and Specifications	19
Warnings	20
Compliance	21
Warranty	22

Introduction

Your Vesper Marine Cortex H1 (tethered) and H1P (portable) VHF Handset and AIS display.

Cortex handsets connect with the Cortex M1 hub and together they work as an AIS Class B SO-TDMA Transponder and Class D VHF Radio with DSC.

The handset is the voice and calling interface used for VHF and DSC calls. The handset's touchscreen display is the primary interface together with dedicated buttons and the Click-Wheel for swift navigation, ease of operation and single-handed use.

The touchscreen is purpose-built for the harsh marine environment and is designed and manufactured for use in wet conditions and with gloves.

The handset provides a screen to set up and manage the Cortex M1 hub, view AIS target data and vessel instrumentation, manage and monitor alarms and configure the remote vessel monitoring.

The H1 version has a spiral tether connected to the vessel's 12V or 24V power (DC) via a bulkhead plug and socket. The H1P includes a robust surface mount cradle to secure the handset in a fixed location and identify it as a VHF radio.

The H1P is designed for freedom of movement on board. The H1P has a battery inside and is held and recharged via the H1P charging cradle that is wired to 12V or 24V power (DC).

Questions and FAQ's

Visit www.vespermarine.com/faqs for answers to frequently asked questions, technical support, downloads, local dealer contacts and more.

Register Your Cortex

Vesper Marine releases product updates from time to time. These updates often add new features. To be notified when an update is available please register your Cortex at www.vespermarine.com/register.

DSC Emergency Calls

To make an Undesignated Distress DSC Call:



1. Lift the red cover on the back of the handset named DISTRESS
2. Press and hold the DISTRESS button for 3 seconds.

Cortex will beep and countdown on screen.

IMPORTANT NOTE - Never make a distress call if your vessel or a person is not in an emergency situation. A distress call should only be made when immediate help is needed.

A distress call should be initiated if, in the opinion of the captain, the vessel and/or a person is in distress requiring immediate assistance.

VHF Emergency Calls

To make an Emergency Call on Channel 16:

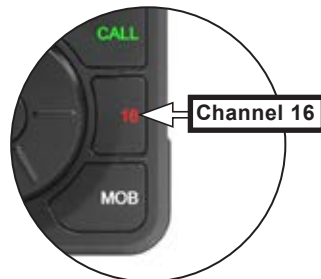





1. **Select Channel 16**
Select key 16 on the handset.
2. **The distress signal "MAYDAY" is spoken three times**
"MAYDAY MAYDAY MAYDAY"
3. **The words "THIS IS", spoken once followed by the name of the vessel in distress (spoken three times) and call sign or boat registration number, spoken once**
"THIS IS BOAT NAME, BOAT NAME, BOAT NAME, CALL SIGN"
4. **Repeat "MAYDAY" and the vessel name, spoken once**
"MAYDAY THIS IS BOAT NAME"
5. **Give position of the vessel**
State your position in Latitude and Longitude. You can see this by pressing the VHF Key on your Cortex Handset. You should also state a geographic position using a bearing and distance to a well-known geographic features or landmark. You can also provide additional information such as current course, speed and destination if you are underway and making way.
6. **State the nature of distress (ie, sinking, fire etc) followed by the type of assistance required**
7. **Give additional information such as the number of persons on board and any other information which might facilitate rescue**

Such as length of vessel, number of persons needing medical attention, hull color, number of masts, etc.

Items you need for installation

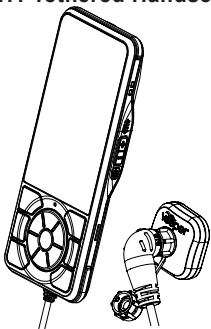
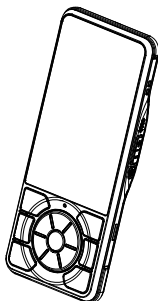
- H1 or H1P (included)
- H1 or H1P cradle (included)
- H1 Bulkhead Connector (included with H1 only)
- 2A fuse or circuit breaker (not included)
- Fastenings of your choice (not included)
- Recommended screws: 316 Stainless Self Tapping 8G/1" (4.2/25.4mm) Pan/Round Head.

Note - H1P is supplied with a H1 non-powered cradle for secure mounting in a secondary position.

<p>H1 Tethered Handset</p> 	<p>H1P Portable Handset</p> 
<p>H1 Non-powered Cradle</p> 	<p>H1P Charging Cradle</p> 
<p>H1 Bulkhead Connector</p> 	<p>Recommended screws</p>  <p>316 S/S Self Tapping 8G/1" (4.2/25.4mm) Pan/Round Head.</p>

Cradle & Bulkhead Connector wiring

A handset draws 12W (1A@12V) maximum. The power cables of both the H1 Bulkhead Connector and the H1P cradle may be extended or shortened as necessary.

- > Connect the positive (+ve red) and negative (-ve black) leads of the power cable to the vessel.
- > Connect a fuse or circuit breaker to the positive lead of the appropriate rating for the circuit. (ie 2A for each handset)

RECOMMENDED - Connect the handset power to a supply that will remain on even when the vessel's batteries may be turned off. (eg, 24hr circuit)

This is important to ensure a handset remains charged and ready for use if it is put into Sleep mode and the vessels batteries are switched off.

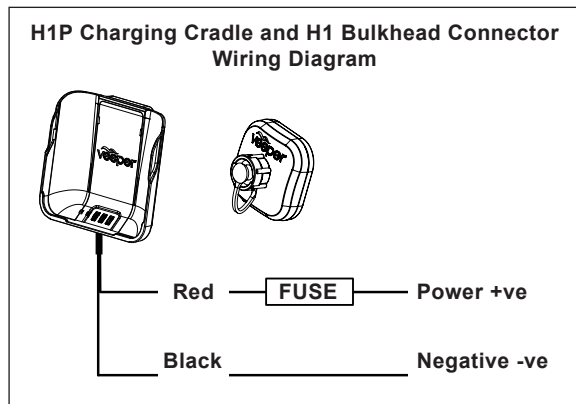

Cradle and Bulkhead Connector wiring color codes

- Red** DC positive (+ve) (12/24 volts).
- Black** DC negative (-ve)

Always use a fuse or circuit breaker installed near the battery end or bus bar end.

Do not connect directly to a battery.

If you must extend the power connections use quality tinned marine grade wire at least 16 AWG (1.5mm²).

Cradle position

A handset cradle can be mounted almost anywhere where a WiFi connection to the M1 can be achieved.

HINT - The WiFi connection status can be monitored by selecting the WiFi icon in the blue Status Bar. The Status Bar is displayed at the top of all handset screens.



Consider the following power connection requirements when choosing a cradle position:

H1 The spiral tether connects via a removable plug to the Bulkhead Connector wired to power (12V or 24V DC). The spiral tether stretches to a maximum length of approximately 2M (6ft).

H1P The H1P is held and recharged via a charging cradle that is wired to power (12V or 24V DC).

CAUTION

- Ensure charging cradle is **NOT** mounted in a wet area or exposed to significant salt spray.
- Ensure that the minimum safe compass distance is maintained. Standard: 0.8m, Steering: 0.4m.

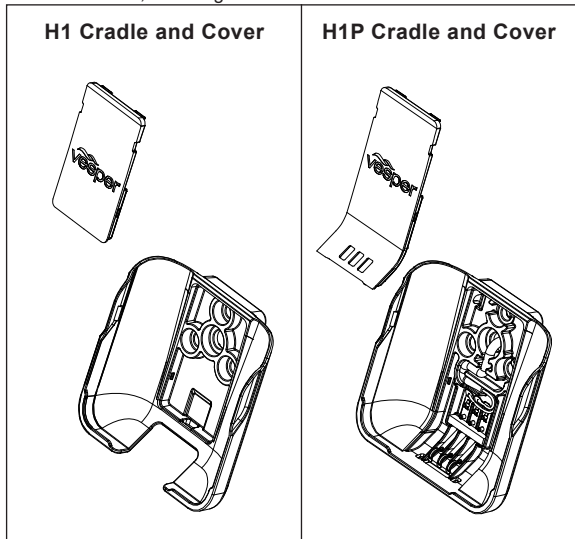

To install a Cradle

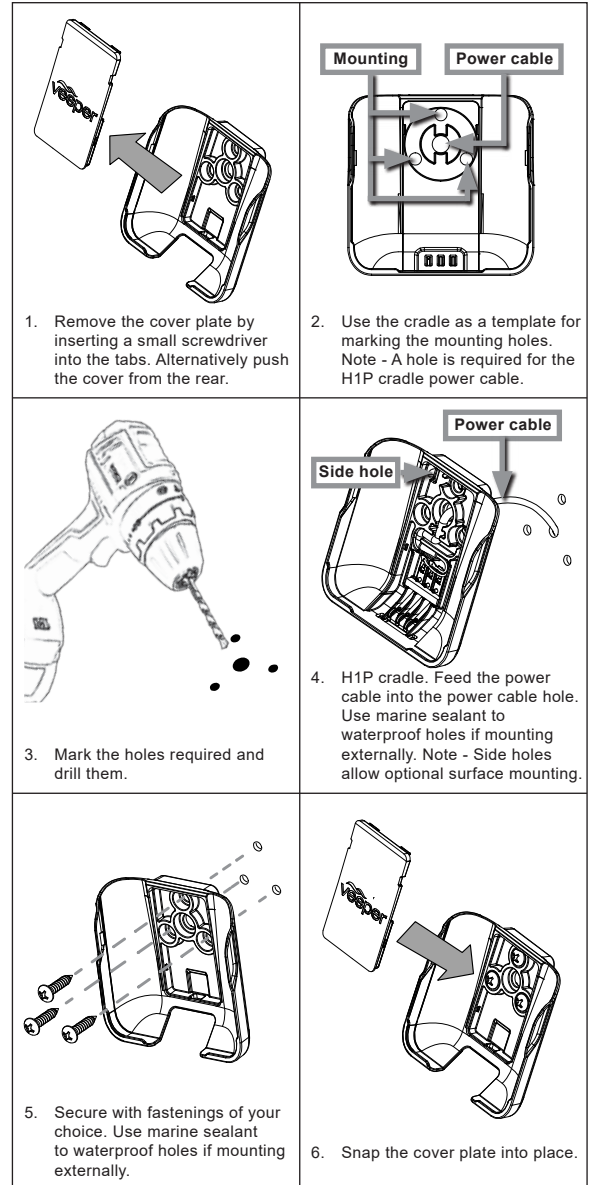

H1 Bulkhead Connector

The Bulkhead Connector can be mounted almost anywhere where a WiFi connection to the M1 hub can be achieved.

Consider the following position and power connection requirements when choosing a Bulkhead Connector location:

- Position the Bulkhead Connector near the H1 cradle.
- The Bulkhead Connector is wired to power (12V or 24V DC).
- The spiral tether cable of the H1 stretches to a maximum length of approximately 2M (6ft).

HINT - The Bulkhead Connector base is supplied pre-assembled and can be rotated in 90 degree increments prior to fastening to achieve a convenient installation angle once the H1 is inserted.

Arrows on the Mounting Base indicate the correct vertical orientation for most installations.

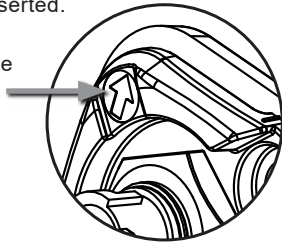

CAUTION - Ensure that the minimum safe compass distance is maintained. Standard: 0.8m, Steering: 0.4m.

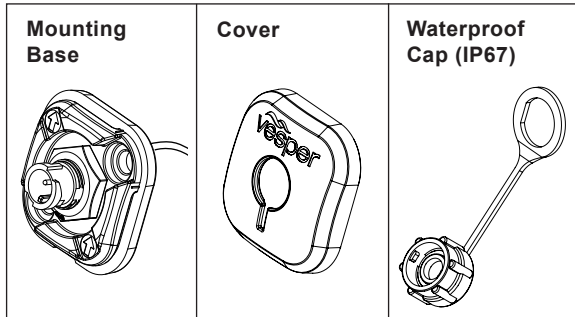

To install a Bulkhead Connector

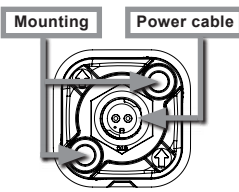
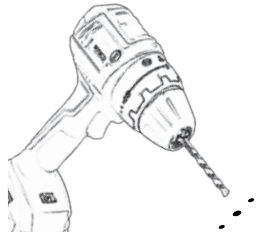
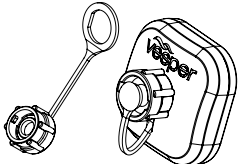
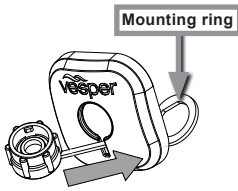
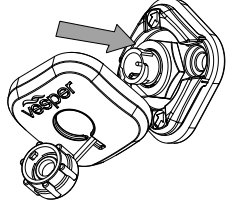
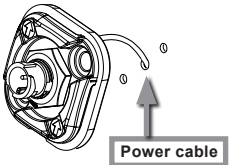
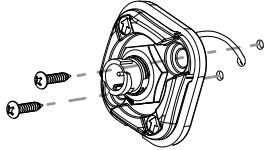
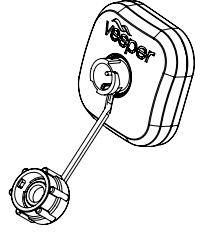
 <p>1. Use the Mounting Base as a template for marking the position of mounting holes and the power cable hole.</p>	 <p>2. Mark the holes required and drill them.</p>
 <p>3. If required (eg, exterior installations) add the Waterproof Cap in steps 3a and 3b.</p>	 <p>3a. Pass the mounting ring of the Waterproof Cap through the keyhole slot of the Cover.</p>
 <p>3b. Slide the mounting ring (with Cap attached) over the thread of the Mounting Base.</p>	 <p>4. Pass the power cable of the Mounting Base through the power cable hole. (Optional Waterproof Cap not shown)</p>
 <p>5. Add marine sealant to waterproof the holes if mounting externally. Secure with fastenings of your choice. (Optional Waterproof Cap not shown)</p>	 <p>6. Snap the Cover onto the Mounting Base.</p>

To connect power to a handset

H1

1. Connect the H1 plug to the H1 Bulkhead Connector.
2. Tighten the plug lock ring (clockwise one quarter turn) for a secure and watertight connection.

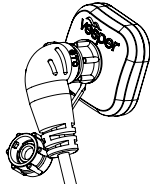

H1P

1. Place the H1P into the charging cradle.

Note - Before first time use ensure the H1P is charged.

To place and remove a handset

Place

- #1 Place the handset on the base of the cradle
- #2 Snap in horizontally.

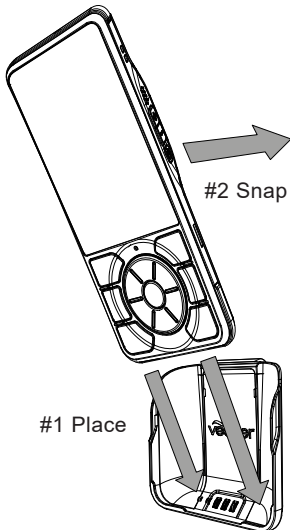

Remove

- Slide the handset upwards.

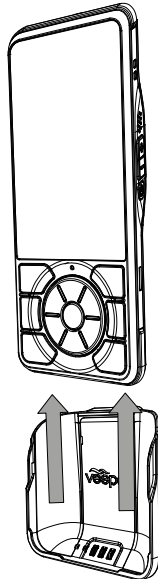

Turning a handset ON

Switch the vessel batteries and/or circuits ON to power the M1 and the H1 Bulkhead Connector and/or the H1P cradle.

- > Press and hold the Power button for 2 seconds until the Vesper logo appears.

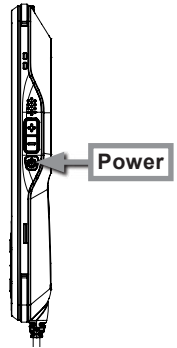

- > Confirm a handset is receiving DC power via these visual checks:

H1

The power light (above the touchscreen) indicates a handset is On when the screen is Off.

H1P

Select the Battery Charge icon in the Status Bar.

(When an H1P is placed into a non-powered cradle, the power light will flash to indicate the H1P is not charging.)

Note - If a handset displays 'Trying to connect...' for a long period, it has not made a WiFi connection to the M1. See '**To connect a handset to an M1**' (pg14) and '**Handset Connection FAQs**' (pg15).

Turning a handset OFF

- > Press and hold the Power button for 2 seconds.
- > Select from the options displayed on screen:
 - > Sleep Powered down for fast boot up. Use while on board the vessel.
 - > Shutdown Complete shut down. Use while off the vessel.
 - > Reboot Complete reboot and restart.

Note - When turned On after Sleep, Shutdown and Reboot, a handset will display the most recently viewed screen.

To connect a handset to an M1

- 1 Turn Cortex M1 ON
Switch the vessel's batteries ON to power the M1.
- 2 Turn the handset ON
Press and hold the Power button for 2 seconds.
- 3 Select WiFi from the Status Bar



- 4 From the list of available WiFi, identify and select the M1 WiFi SSID.

Note - The WiFi SSID is identified by the M1 serial number eg: CORTEX-95211616

Note - The Cortex V1 package (M1+H1) ships with the handset pre-configured to the M1.

- 5 Key the WiFi Password found on the label supplied with the M1.
- 6 Select CONNECT to save.
Text '*connected*' will confirm the connection.
- 7 Select the Back key to close the WiFi status.

Handset connection FAQs

If the handset displays '**Trying to connect...**' for a long period, it has not made a WiFi connection to the M1.

- > Check the M1 is ON.
- > Check the WiFi signal strength in the Status Bar.
- > Check the M1 WiFi External Antenna is attached.
- > Consider the distance between the handset and M1 on board. Some objects and materials may provide interference to degrade the WiFi signal strength.
- > See '**To connect a handset to an M1**' (pg14).
Follow Step 3 to identify and connect to the WiFi.

Note - The WiFi status icon on the M1 will illuminate green when a handset or app makes a connection.

If the screen displays '**No GPS position!**' while beeping alarm, touch the screen (or any key) to silence the alarm and close this notification.

The handset will then display '**Waiting for GPS...**', the M1 has not acquired GPS position.

- > Check GPS Status in the Status Bar of the handset (or Cortex Onboard App) to view the satellite signal strengths.
- > Check the M1 external GPS installation.
- > Check the GPS icon on the M1 indicator panel.

vesper

CORTEX M13G

Serial No. XXXXXXXX

Wifi SSID:
CORTEX - XXXXXXXX

Wifi Password:
XXXXXXXXXX

Scan QR - code to connect to M1 HUB
Check installation guide for further detail

Place supplied
WiFi label here

Caution - The WiFi
SSID or password
cannot be changed,
please ensure the
labels do not get lost.

www.vespermarine.com



To connect mobile devices to an M1

To connect Android and Apple iOS devices to the WiFi of the M1, scan the QR code of the M1 (found on the WiFi label) to be automatically connected.

You can also manually select the WiFi network and key the password from the label.

To program your MMSI number

Before an M1 can transmit your position over AIS you must configure your vessel details and enter a valid MMSI number.

Your MMSI may have been entered by your dealer. You must have an assigned MMSI for your vessel.

If you do not have an assigned MMSI, contact the relevant authority in your country.

You can configure your MMSI using the Cortex Onboard App or a Cortex handset. Please refer to the MMSI Programming Warning below.

Once you save the MMSI number you cannot change it. If you need to change the MMSI, please contact an authorized dealer or Vesper Marine.

To program your MMSI with a handset

- > Main Menu (☰). Touch on the wrench icon (🔧) to open the Configuration Menu.
 - > Vessel
 - > Vessel Identification
 - > MMSI (Enter MMSI number)
 - > Name (Enter the vessel's name)
 - > Callsign (Enter the vessel's callsign)
 - > Vessel Type (Select from the list)

MMSI Programming Warning

For Customers in the USA: This device must be programmed with data corresponding to the vessel on which it will be installed.

Programming must be carried out by a Vesper Marine dealer. The included instructions contain information on how to verify the correct programming.

WARNING: It is a violation of the rules of the Federal Communications Commission to input an MMSI that has not been properly assigned to the end user, or to otherwise input any inaccurate data in this device.

To program your VHF

To program your ATIS ID

ATIS is a vessel identification system used on inland waterways in some European countries.

To program your ATIS ID with a handset

- > Main Menu (☰). Touch on the wrench icon (🔧) to open the Configuration Menu.
 - > Vessel > ATIS identification > key your ATIS ID

Note - If you do not have an ATIS number select 'Suggest ID' to generate a number based on your vessel's MMSI number.

- > Select "tick icon" to save the number.

The handset will display the following;

*"Once set, you cannot change your ID.
Please verify that your id is xxxxxxxxxx"*

If the number is correct, select "THAT IS MY ID".

Note - The operation can be canceled by selecting the 'back' key. You can program your ATIS identification number only once. Contact your Vesper Marine dealer if you must change your ATIS ID after entering it.

To Enable ATIS

- > Main Menu (☰). Touch on the wrench icon (🔧) to open the Configuration Menu.
 - > Systems > VHF > Select Region
 - > Enable ATIS via the check box.

Note - Cortex disables DSC when you enable ATIS.

To program your VHF Region

- > Main Menu (☰). Touch on the wrench icon (🔧) to open the Configuration Menu.
 - > Systems > VHF > Select Region
 - > Select your region from the list.

Recommended handset care

For a long service life:

- Avoid leaving a handset outside and exposed to the elements over winter.
- Use Shutdown when you are away from the vessel for an extended period of time.
- Regularly clean the H1P charging contacts.
- Take care of the glass touchscreen around solid objects such as winch handles and anchors.
- Ensure charging cradle is not mounted in a wet area or exposed to significant salt spray. This may cause a build up of salt residue that will affect charging or damage from accelerated galvanic corrosion.

To avoid damaging the handset and reduce the risk of fire or electric shock, explosion, or other hazards, observe the following safety precautions:

- Always use the correct cradle when charging. Third-party chargers can cause fire, electric shock, injury, or damage to the handset or other property.
- Protect the H1 spiral cable by avoiding bending, twisting, pulling, heating, or placing heavy items on it.
- Do not attempt to repair or modify or re-manufacture the handset. It is equipped with an internal rechargeable battery to be replaced only by Vesper Marine or an authorized Vesper Marine dealer.
- Do not open, disassemble, crush, bend, deform or puncture the handset.
- Do not insert foreign objects into the handset.
- Do not place the handset in a microwave oven.
- Do not expose the handset to fire or explosion.

Recommended handset use

The handset has a powerful internal speaker for loud and clear VHF voice and alarm notification;

- Avoid listening with the handset close to your ear.
- Hold the handset away from your ear and view the display screen as you use the VHF.

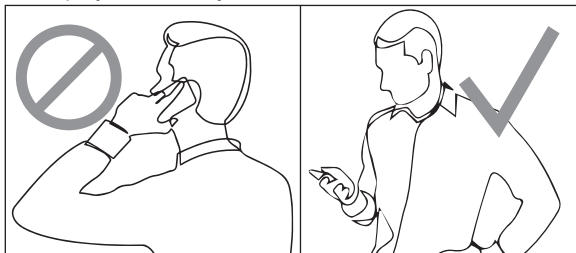

Dimensions and Specifications

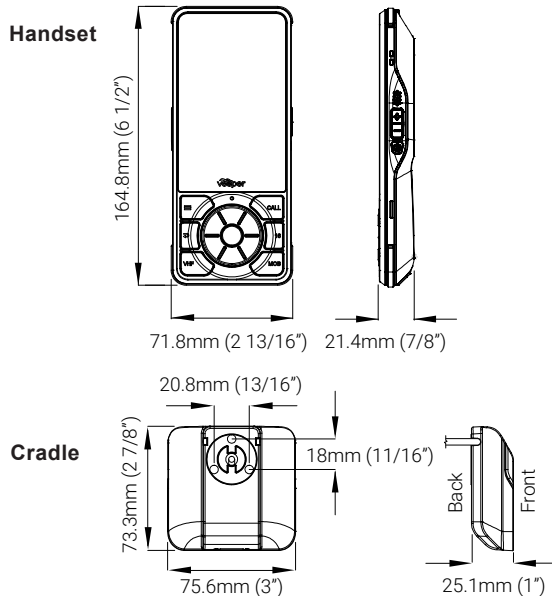

SPECIFICATIONS	
HANDSET SIZE	164.8 x 71.8 x 21.4mm (6 1/2" x 2 13/16" x 7/8")
POWER SUPPLY	12V, 1A max, 200mA nom 12/24V DC compatible
BATTERY	Lithium Polymer 2 hour full charge, >10 hours operation
WEIGHT	H1 285g (0.63lb), H1P 235g (0.52lb)
ENVIRONMENTAL	Waterproof (IPX8)
OPERATING TEMP	-25°C to +55°C (-13°F to +131°F)
AUDIO	3W Class D amplifier, THD < 5% @ 85dBA

DISPLAY	
SCREEN	LCD TFT Si, 640 x 800, 24bit color
TOUCH	Capacitive, optically bonded, LCD, glove and salt water operable
BACKLIGHT	600 cd/m2, Ambient Light sensor for auto dimming

All stated specifications are subject to change without notice or obligation. Dimensional measurements based on metric.

Warnings

Intended Use

This product is intended to be used on leisure or commercial vessels (excluding IMO/SOLAS class). Vesper Marine has designed and manufactured this product to be used only aboard vessels.

Warranty Void

Do not disassemble the unit or remove the screws which hold it together. The unit is sealed and disassembly will void the warranty.

FCC Warning

This device complies with Part 15 of the FCC Rules. Operation is subject to the following two conditions:

(1) this device may not cause harmful interference and (2) this device must accept any interference received, including interference that may cause undesired operation.

Industry Canada Warning

This device complies with Industry Canada license-exempt RSS standard(s). Operation is subject to the following two conditions: (1) this device may not cause interference, and (2) this device must accept any interference, including interference that may cause undesired operation of the device. This device complies with RSS-310 of Industry Canada. Operation is subject to the condition that this device does not cause harmful interference.

MMSI Programming Warning

IMPORTANT: In most countries the operation of a VHF unit may require the possession of a current VHF radiotelephone license which lists the AIS system and the vessel Call Sign and MMSI number.

An MMSI number is required in order for this device to operate DSC or as an AIS transmitter. Please contact the relevant authority in your country for more information.

For Customers in the USA

This device must be programmed with data corresponding to the vessel on which it will be installed. Programming must be carried out by a Vesper Marine dealer. The included instructions contain information on how to verify the correct programming.

WARNING: It is a violation of the rules of the Federal Communications Commission to input an MMSI that has not been properly assigned to the end user, or to otherwise input any inaccurate data in this device

DSC Distress Button

WARNING: Under no circumstances shall a DSC distress alert be sent to test your VHF radio. It is a violation of the rules of the US Coast Guard and other international Coastal Authorities and can result in heavy fines. The DSC Distress button must be used only in case of life threatening emergencies. Refer to DSC on page 4.

Battery Warnings

- Do not disassemble, open, crush, bend, puncture or shred this device.
- Make sure no sharp-edged items, such as animals' teeth or claws, come into contact with the battery. This could cause a fire.
- Only use the battery for the device for which it is specified.
- Use of an unqualified battery or charger may present a risk of fire, explosion, leakage, or other hazard.

CAUTION: The battery is not user serviceable. If the battery is no longer holding charge, please contact Vesper marine technical support.

Notice for Battery Replacement - The handset has an internal battery. For your safety, do not remove the battery inside the handset. Contact an authorized Vesper Marine dealer or contact Vesper marine technical support. Battery replacement by non-qualified professionals can cause damage to the handset.

Compliance

RF Exposure Compliance Statement

This device was tested for typical body-worn operations. To comply with RF exposure requirements, a minimum separation distance of 0 mm should be maintained between the user's body and 25 mm from front of face. This device complies with FCC radiation exposure limits set forth for an uncontrolled environment. This equipment complies with IC RSS-102 radiation exposure limits set forth for an uncontrolled environment. This transmitter must not be co-located or operating in conjunction with any other antenna or transmitter.

Cet équipement est conforme aux limites d'exposition aux radiations IC CNR-102 établies pour un environnement non contrôlé. Cet émetteur ne doit pas être situé ou fonctionner conjointement avec une autre antenne ou un autre émetteur.

Specific Absorption Rate (SAR) Values

This product transmits and receives radio signals. It is designed and manufactured not to exceed the emission limits for exposure to Radio Frequency (RF) energy set by the Federal Communications Commission of the U.S. Government. These standards include a substantial safety margin designed to assure the safety of all persons, regardless of age and health.

The exposure standard for wireless products employs a unit of measurement known as the Specific Absorption Rate, or SAR. In the United States and Canada, the SAR limit for a handheld device is 1.6 watts/kg (W/kg) averaged over one gram of tissue, or 4.0 watts/kg (W/kg) averaged over ten grams of tissue. The highest SAR value for your handset is 0.01 W/kg (1 g) when tested for use Front of Face (25mm) and 0.07 W/kg (10 g) for Extremities (0mm).

Regulatory Information

To view regulatory marks and related information;

- > Main Menu. Touch on the wrench icon  to open the Configuration Menu.
- > Systems > Certifications.

Water Resistant Properties

Cortex handsets are water and dust resistant in compliance with the Ingress Protection rating IPX8 and have undergone testing in a controlled environment.

Cortex handsets are proven to be water resistant in certain circumstances (the handsets meet the requirements of classification IPX8 as described by the international standard IEC 60529 - 2013 Degrees of Protection provided by Enclosures [IP Code]); test conditions: 23±3°C/73.4±5 °F, R.H. approximately 2 meters, for 60 minutes).

Do not use the handset in the following environments:

- Do not immerse the handset in a hot spring.
- Do not swim while wearing this handset.
- Do not immerse the handset in water deeper than approximately 2m.
- Do not immerse the handset in water for longer than 60 minutes.
- Do not place the handset directly on sand or mud.
- Do not mount the handset in places where it may be sprayed with high pressure water or submerge it in water for extended periods of time, the handset is not designed to withstand high water pressure.

If the handset has been immersed in water or if the microphone or speaker has gotten wet, VHF sound quality may be affected.

The handset's water and dust resistant features may be damaged by dropping or receiving an impact.

Warranty

Your Vesper Marine Cortex product is warranted, when properly installed and used, to be free from defects in materials or workmanship for two years from the date the product was purchased by the first retail customer. This warranty applies to the original retail purchaser only and is not transferable. This warranty only applies to products purchased from Vesper Marine or from an authorized Vesper Marine reseller. Within this period, Vesper Marine will, at its discretion, repair or replace any components which fail in normal use. Repairs or replacement will be made at no charge for parts or labor, provided that the customer shall be responsible for any transportation costs. This warranty does not cover failures due to abuse, misuse, accident, improper installation, unauthorized alterations or repairs, shipping damage, wear and tear, or corrosion.

This warranty does not cover defects or damage caused if the product's external housing has been opened, the serial number or other labels have been removed or altered, or the specified input voltage has been exceeded. This warranty does not cover defects or damage caused if the product has been operated with an incompatible GPS antenna or without a suitable VHF antenna, or with an incompatible antenna splitter, where applicable to the product.

Vesper Marine retains the exclusive right to repair or replace the unit at its sole discretion. In the event Vesper Marine chooses to replace the unit it may be replaced with a factory reconditioned unit or a new unit at its sole discretion. Where a replacement is provided the original product becomes the property of Vesper Marine and the warranty will remain from the original purchase date.

THE WARRANTIES AND REMEDIES CONTAINED HEREIN ARE EXCLUSIVE AND IN LIEU OF ALL OTHER WARRANTIES, WHETHER EXPRESS, IMPLIED OR STATUTORY, INCLUDING ANY LIABILITY ARISING UNDER ANY WARRANTY OF MERCHANTABILITY OR FITNESS FOR A PARTICULAR PURPOSE, STATUTORY OR OTHERWISE. THIS WARRANTY GIVES YOU SPECIFIC LEGAL RIGHTS, WHICH MAY VARY FROM STATE TO STATE.

IN NO EVENT SHALL VESPER MARINE BE LIABLE FOR ANY INCIDENTAL, SPECIAL, INDIRECT, OR CONSEQUENTIAL DAMAGES, WHETHER RESULTING FROM THE USE, MISUSE OR INABILITY TO USE THE PRODUCT OR FROM DEFECTS IN THE PRODUCT. SOME STATES DO NOT ALLOW THE EXCLUSION OF INCIDENTAL OR CONSEQUENTIAL DAMAGES, SO THE ABOVE LIMITATIONS MAY NOT APPLY TO YOU.

Vesper Marine retains the exclusive right to repair or replace the product or offer a full refund of the purchase price at its sole discretion. SUCH REMEDY SHALL BE YOUR SOLE AND EXCLUSIVE REMEDY.

*These warranty terms and conditions are provided as a summary and the specific terms and conditions of your warranty may vary by region. Please see www.vespermarine.com/warranty for details of the warranty terms and conditions specific to your region.



Electronic Waste Recycling

Various regional and national regulations exist regarding the recycling of certain electronics. Please consult your local authorities or contact Vesper Marine for recycling information.

Vesper Marine declares that this product is in compliance with Directive 2014/53/EU.

The full text of the EU Declaration of Conformity is available at the following internet address: www.vespermarine.com/compliance

This product is for use worldwide, including the following countries:

AT	BE	BG	CH	CY	CZ	DE	DK	EE	ES
FI	FR	GR	HU	IE	IS	IT	LT	LU	☑
MT	NO	NL	PL	PT	RO	SE	SI	SK	UK



Copyright © 2020, Vesper Marine Ltd.

Vesper Marine, Vesper, Cortex, VHF Reimagined, WatchMate, AIS WatchMate, WatchMate Vision, deckWatch, smartAIS and Always On Always Visible Always Watching are trademarks or registered trademarks of Vesper Marine Ltd.

All other products are trademarks or registered trademarks of their respective owners.

Unless otherwise indicated, all documentation and operating software contained within this product or distributed with this product is copyrighted by Vesper Marine Ltd. All rights are reserved.

Portions of this product may use software licensed under open source license agreements. Source code for the applicable software is available upon request from Vesper Marine Ltd.

Member of:



45 Sale Street, Freemans Bay,
Auckland, New Zealand.
Phone +64 9 950 4848

info@vespermarine.com www.vespermarine.com

www.facebook.com/vespermarine