

COBHAM

SAILOR 500/250 FleetBroadband Including 19" Rack Version

User manual



SAILOR 500 FleetBroadband SAILOR 250 FleetBroadband Including 19" Rack Version

User manual

Document number: 98-125645-J

Release date: January 2, 2018

Disclaimer

Any responsibility or liability for loss or damage in connection with the use of this product and the accompanying documentation is disclaimed by Thrane & Thrane A/S. The information in this manual is provided for information purposes only, is subject to change without notice and may contain errors or inaccuracies. Manuals issued by Thrane & Thrane A/S are periodically revised and updated. Anyone relying on this information should acquire the most current version e.g. from www.cobham.com/satcom, **Cobham SYNC Partner Portal**, or from the distributor. Thrane & Thrane A/S is not responsible for the content or accuracy of any translations or reproductions, in whole or in part, of this manual from any other source. In the event of any discrepancies, the English version shall be the governing text.

Thrane & Thrane A/S is trading as Cobham SATCOM.

Copyright

© 2018 Thrane & Thrane A/S. All rights reserved.

Manufacturer address

Thrane & Thrane A/S, Lundtoftegaardsvej 93 D, DK-2800, Kgs. Lyngby,
Denmark

Trademark acknowledgements:

- **SAILOR** is a registered trademark of Thrane & Thrane A/S in the European Union, the United States and other countries.
- **Windows** is a registered trademark of Microsoft Corporation in the United States and other countries.
- **Inmarsat** is a registered trademark of International Maritime Satellite Organisation (IMSO) and is licensed by IMSO to Inmarsat Limited and Inmarsat Ventures plc.
- Inmarsat's product names are trademarks or registered trademarks of Inmarsat.
- Other product and company names mentioned in this manual may be trademarks or trade names of their respective owners.

Company web site
www.cobham.com/satcom

Safety summary

The following general safety precautions must be observed during all phases of operation, service and repair of this equipment. Failure to comply with these precautions or with specific warnings elsewhere in this manual violates safety standards of design, manufacture and intended use of the equipment. Thrane & Thrane A/S assumes no liability for the customer's failure to comply with these requirements.

Observe marked areas

Under extreme heat conditions do not touch areas of the terminal or antenna that are marked with this symbol, as it may result in injury.



Microwave radiation hazards

During transmission the antenna in this system radiates Microwave Power. This radiation may be hazardous to humans close to the antenna. During transmission, make sure that nobody gets closer than the recommended minimum safety distance.

On the **SAILOR 500 FleetBroadband**, the minimum safety distance to the antenna panel on the focal line is 1.3 m, based on a radiation level of 10 W/m^2 . The radiation level is 100 W/m^2 at a distance of 0.4 m from the antenna panel. Refer to the drawing on the next page.



Pour une antenne **SAILOR 500 FleetBroadband**, la distance de sécurité minimale avec le panneau de l'antenne sur l'axe focal est de 1.3 m, sur la base d'un niveau de radiation émis de 10 W/m^2 . L'appareil génère un niveau de radiation de 100 W/m^2 à une distance de 0.4 m de l'avant du panneau de l'antenne. Veuillez consulter le schéma sur la page suivante.

On the **SAILOR 250 FleetBroadband**, the minimum safety distance to the antenna panel on the focal line is 0.6 m, based on a radiation level of 10 W/m^2 . The radiation level is 100 W/m^2 at a distance of 0.2 m from the antenna panel. Refer to the drawing below.



Pour une antenne **SAILOR 250 FleetBroadband**, la distance de sécurité minimale avec le panneau de l'antenne sur l'axe focal est de 0.6 m, sur la base d'un niveau de radiation émis de 10 W/m². L'appareil génère un niveau de radiation de 100 W/m² à une distance de 0.2 m de l'avant du panneau de l'antenne. Veuillez consulter le schéma au-dessous.

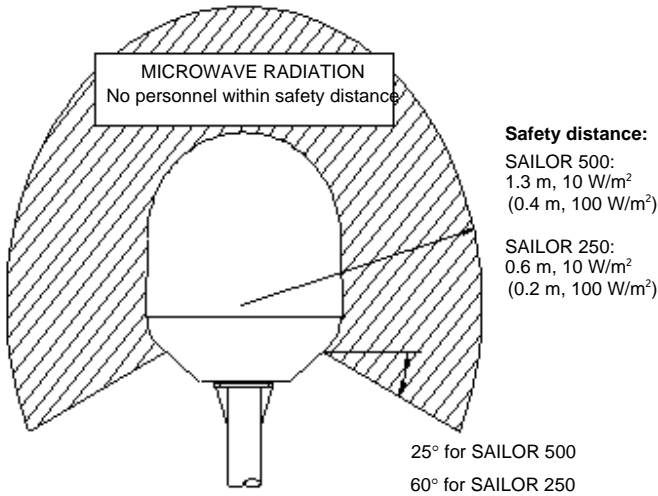

Distance to other equipment

Do not move the antenna closer to radars than the min. safe distance specified in the installation manual - it may cause damage to the antenna.

Compass Safe Distance:

SAILOR FleetBroadband Terminal: min. 0.3 m.

SAILOR 500 FleetBroadband antenna: min. 1.0 m

SAILOR 250 FleetBroadband Antenna: min. 1.1 m

Service

User access to the interior of the terminal is prohibited. Only a technician authorized by Cobham SATCOM may perform service - failure to comply with this rule will void the warranty. Access to the interior of the antenna is allowed, but only for replacement of certain modules - as described in the Installation manual. General service may only be performed by a technician authorized by Cobham SATCOM.

Do not service or adjust alone

Do not attempt internal service or adjustments unless another person, capable of rendering first aid resuscitation, is present.

Grounding, cables and connections

To minimize shock hazard, the equipment chassis and cabinet must be connected to an electrical ground. The terminal must be grounded to the ship. For further grounding information refer to the Installation manual.

Do not extend the cables beyond the lengths specified for the equipment. The cable between the terminal and antenna can be extended if it complies with the specified data concerning cable losses etc.

All cables for the SAILOR FleetBroadband system are shielded and should not be affected by magnetic fields. However, try to avoid running cables parallel to AC wiring as it might cause malfunction of the equipment.

Power supply

The voltage range is 10.5 - 32 V DC; 14 A - 5.5 A. It is recommended that the voltage is provided by the 24 V DC bus on the ship. Be aware of high start-up peak current: 20 A@24 V, 5 ms.

If a 24 V DC power bus is not available, an external 115/230 VAC to 24 V DC power supply can be used.

Do not operate in an explosive atmosphere

Do not operate the equipment in the presence of flammable gases or fumes. Operation of any electrical equipment in such an environment constitutes a definite safety hazard.

Keep away from live circuits

Operating personnel must not remove equipment covers. Component replacement and internal adjustment must be made by qualified maintenance personnel. Do not replace components with the power cable connected. Under certain conditions, dangerous voltages may exist even with the power cable removed. To avoid injuries, always disconnect power and discharge circuits before you touch them.

Failure to comply with the rules above will void the warranty!

About the manual

Intended readers

This manual is a user manual for the SAILOR 500 FleetBroadband system and the SAILOR 250 FleetBroadband System. The readers of the manual include anyone who is using or intends to use one of these two systems. No specific skills are required to operate the SAILOR FleetBroadband System. However, it is important that you observe all safety requirements listed in the beginning of this manual, and operate the system according to the guidelines in this manual.

Most current version

This manual may not always reflect the latest software functionality of your SAILOR FleetBroadband System. To obtain the latest version of the manual, go to www.cobham.com/satcom, **Cobham SYNC Partner Portal**, and download the latest version, or acquire it from your distributor.

Manual overview

Note that this manual does not cover installation nor does it cover how to use the IP Handset that comes with the system. For information on installation refer to the installation manual and for information on the IP Handset refer to the user manual for the IP Handset. Part numbers for both manuals are listed in the next section. This manual has the following chapters:

- **Introduction** contains a brief description of the system and an overview of the BGAN services.
- **To get started** explains how to insert SIM (Subscriber Identity Module) card and start up the unit. It also contains a short guide to making the first call.
- **To operate the system** explains how to use the system.
- **To use the web interface** explains how to use the built-in web interface of the terminal for configuration and daily use, and describes the available menus and settings, including advanced setup of interfaces.
- **Troubleshooting** contains a short troubleshooting guide and explains how to update software. It also describes the functions of the light indicators and the Reset button and explains the event messages that may show in the web interface. Further, it shows where to get help if needed.

- **Conformity** contains declarations of conformity for the SAILOR FleetBroadband and the SAILOR FleetBroadband 19” rack systems.

Related documents

The below list shows the documents related to this manual and to the SAILOR 500 FleetBroadband and SAILOR 250 FleetBroadband Systems.

Title and description	Document number
<p>SAILOR 500/250 FleetBroadband, Including 19” Rack Version, Installation Manual</p> <p>Explains how to install the SAILOR FleetBroadband terminal, the SAILOR 500 FleetBroadband antenna and the SAILOR 250 FleetBroadband antenna.</p>	98-125646
<p>SAILOR 500/250 FleetBroadband, Quick Guide</p> <p>A short guide to the most important functions of the SAILOR FleetBroadband systems.</p>	98-125647
<p>IP Handset, User Manual</p> <p>Explains the features and functions of the IP handset. The IP handset works as a standard IP handset, but also serves as a user interface for the SAILOR FleetBroadband systems.</p>	98-126059
<p>Voice Distress (Non-SOLAS), User manual</p> <p>Explains how to use the IP handset for making Distress and Urgency calls using an alarm panel and a SAILOR FleetBroadband system.</p>	98-133687
<p>Voice Distress (Non-SOLAS), Installation manual</p> <p>Explains how to install the Voice Distress (Non-SOLAS) system.</p>	98-133688
<p>SAILOR 500 FleetBroadband Dual Antenna Solution, Installation and user manual</p> <p>Explains how to install and configure the Dual Antenna Solution.</p>	98-138669

Typography

In this manual, typography is used as indicated below:

Bold is used for the following purposes:

- To emphasize words.
Example: “Do **not** touch the antenna”.
- To indicate what the user should select in the user interface.
Example: “Select **SETTINGS > LAN**”.

Italic is used to emphasize the paragraph title in cross-references.

Example: “For further information, see *Connecting Cables* on page...”.

Table of contents

Chapter 1 Introduction

Welcome	1
Features and interfaces	3
Main units	5
The Inmarsat BGAN system	11
Services and interfaces	17

Chapter 2 To get started

Before you start	19
To start up the terminal	21
To connect the IP handset	25
To connect a computer	26
To enter the SIM PIN for the terminal	27
To register with the BGAN network	30
To make the first call	33
Standard connection to the Internet (default)	35

Chapter 3 To operate the system

General	37
To use a phone or fax machine	42
Multi-voice (optional)	58
Voice Distress (optional)	63
To use a computer	64
To use the IP Handset	76

Chapter 4 To use the web interface

Introduction 77

To enter the SIM PIN in the web interface 82

To use the Dashboard 83

To use the phone book 87

To use the Call log 93

To handle SMS messages 96

To set up the interfaces 103

To manage LAN network users 142

To upload software 158

To select the preferred BGAN satellite 162

To select the language 163

Administration 164

Help desk and diagnostic report 197

Event logging and self test 198

Site map 200

Chapter 5 Troubleshooting

To get support 201

To upload software using the web interface 202

To upload software using the TMA 202

Part numbers 204

Troubleshooting guide 206

Status signalling 213

Logging of events 234

	Reset button	235
	List of reserved IP subnets	237
	Supported AT commands for PPPoE	238
App. A	Conformity	
	SAILOR 500 FleetBroadband	243
	SAILOR 250 FleetBroadband	245
Glossary	247
Index	253

Introduction

Welcome

Congratulations on the purchase of your SAILOR FleetBroadband System!

SAILOR 500 FleetBroadband and SAILOR 250 FleetBroadband are maritime broadband systems, that provide simultaneous high-speed data and voice communication via satellite through the BGAN (Broadband Global Area Network).



Applications include:

- Internet browsing
- E-mail
- Phone and fax services
- Large file transfers
- Video conferencing and Streaming
- VPN (Virtual Private Network) access to corporate servers

This chapter has the following sections:

- *Features and interfaces*
- *Main units*
- *The Inmarsat BGAN system*
- *Services and interfaces*

Features and interfaces

The SAILOR FleetBroadband System offers the following features and interfaces:

- Simultaneous voice and data communication over BGAN
- Full duplex, single or multi-user, up to:
SAILOR 500 FleetBroadband: 492 kbps
SAILOR 250 FleetBroadband: 284 kbps
- Support for streaming IP at:
SAILOR 500 FleetBroadband: 8, 16, 32, 64, 128 and 256 kbps
SAILOR 250 FleetBroadband: 8, 16, 32, 64 and 128 kbps
- ISDN (Integrated Services Digital Network) service, only
SAILOR 500 FleetBroadband: 64 kbps
- Voice: Standard Voice (4 kbps) or 3.1 kHz Audio
- Optional Multi-voice feature: up to 9 concurrent voice calls (max. 6 for SAILOR 250 FleetBroadband)
- Optional Voice Distress feature
- 4 LAN (Local Area Network) ports with PoE (Power over Ethernet) for computers, e-hubs, IP handsets etc.
- 2 Standard Phone/Fax ports for standard phones or fax machines
- 1 Euro ISDN port for ISDN phones or, for SAILOR 500 FleetBroadband only: G4 fax or ISDN modem
- 1 L-Band output for connecting a broadcast receiver for maritime data
- 1 multi-purpose I/O connector with 5 configurable inputs/outputs
- 1 SIM slot for your BGAN SIM card
- Support for GPS, GLONASS and BeiDou-1 positioning systems
- Built-in DHCP/NAT router
- Built-in web interface allowing you to manage your phone book, messages and calls, and customize the terminal to your specific needs
- Input power: 10.5 - 32 V DC (14 A - 5.5 A)

- CE certified
- ATC resilient
- Supports Inmarsat's extended L-band services with Alphasat (Inmarsat I-4A F4)

Main units

SAILOR 500/SAILOR 250 FleetBroadband

The main difference between the SAILOR 500 FleetBroadband system and the SAILOR 250 FleetBroadband system lies in the antenna.

- **SAILOR 500 FleetBroadband** uses the TT-3052A/B/C antenna, which is a maritime BGAN Class 8 antenna.

The TT-3052A/B/C antenna is larger and provides more bandwidth than the TT-3050A antenna used for the SAILOR 250 FleetBroadband system.

- **SAILOR 250 FleetBroadband** uses the TT-3050A antenna, which is a medium size, maritime BGAN Class 9 antenna.

The SAILOR 500 FleetBroadband system and the SAILOR 250 FleetBroadband system basically use the same type of terminal, except that the SAILOR 500 FleetBroadband offers a few more features than the SAILOR 250 FleetBroadband. See *Features and interfaces* on page 3.

Units overview

The **SAILOR 500 FleetBroadband system** includes the following main units:

- TT-3052A/B/C SAILOR 500 FleetBroadband antenna
- TT-3738A SAILOR FleetBroadband Terminal or TT-3738A-T19 SAILOR FleetBroadband 19" Rack Terminal
- TT-3670A IP Handset & Cradle, wired

The **SAILOR 250 FleetBroadband System** includes the following main units:

- TT-3050A SAILOR 250 FleetBroadband Antenna
- TT-3738A SAILOR FleetBroadband Terminal or TT-3738A-T19 SAILOR FleetBroadband 19" Rack Terminal
- TT-3670A IP Handset & Cradle, wired

SAILOR FleetBroadband Antennas

SAILOR 500 FleetBroadband antenna

The SAILOR 500 FleetBroadband system uses the **TT-3052A/B/C** antenna, which is a maritime 3-axis controlled BGAN antenna. The antenna contains all functions for satellite tracking, including a GNSS (Global Navigation Satellite System). A single coaxial cable carries all RF communication, supply voltage and modem communication between the antenna and the terminal. For information on how to install the antenna, refer to the installation manual.



This antenna is larger and provides more bandwidth than the TT-3050A used for the SAILOR 250 FleetBroadband system.

SAILOR 250 FleetBroadband antenna

The SAILOR 250 FleetBroadband System uses the **TT-3050A** antenna, which is a medium size maritime 2-axis stabilized BGAN antenna.

For information on how to install the antenna, refer to the installation manual.



SAILOR FleetBroadband Terminal

Overview

Whether you have purchased a SAILOR 500 FleetBroadband system or a SAILOR 250 FleetBroadband system, the terminal is basically the same. For this reason this section covers both systems.

The SAILOR FleetBroadband Terminal is the controlling unit in the SAILOR FleetBroadband System. It contains all user interfaces and LED indicators and stores configuration data.



The terminal is also available in a 19" Rack version. The 19" Rack terminal is the same as the basic version, except for the housing which fits in a 19" rack and has an additional power switch on the front panel.



For details on how to install the terminal, refer to the installation manual.

Tools for setup and daily use

The **IP Handset** can be used to display status, access a subset of controls and views, starting a streaming session and enter the PIN code for the terminal. The IP Handset connects to the LAN interface of the terminal. For information on how to use the handset, see the user manual for the IP Handset.

The built-in **web interface** in the terminal is used for easy configuration and daily use. The web interface is accessed from a computer connected to the terminal, using an Internet browser. No installation of software is needed.

For details on the web interface, see Chapter 4, *To use the web interface*.

The **ThraneLINK Management Application (TMA)** is a Windows program that provides monitoring and software update of connected Cobham SATCOM devices with ThraneLINK support. The devices must be on the same LAN.

For information on how to update software with the TMA, see *To upload software using the TMA* on page 202.

SIM card

The terminal has a SIM (Subscriber Identity Module) slot located in the connector panel behind a small cover plate. The terminal requires a dedicated FleetBroadband SIM card, which you get from your Airtime Provider.

The system requires a SIM card to go online and to access the settings of the terminal. However, using the web interface you can view the Dashboard and upload software without a SIM card.

IP Handset and cradle

IP Handset

The IP Handset communicates using Internet Protocols (IP). The handset is not strictly dedicated to the SAILOR FleetBroadband System, but can also be used in a public network as a standard IP telephone.

The IP Handset is powered directly from the LAN interface using Power over Ethernet (PoE).



When connected to the terminal the IP Handset provides a dedicated BGAN menu with a subset of the terminal configuration options.

For more information on the functions of the IP Handset, refer to the user manual for the IP Handset.

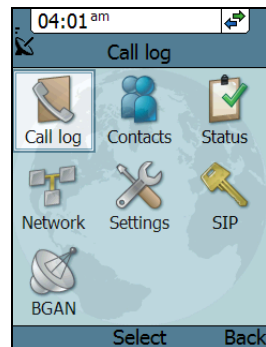

IP cradle

The IP cradle serves as a holder for the IP Handset. The cradle connects to the coil cord from the handset and, using an Ethernet cable, to the terminal. You can mount the cradle on a wall or a desktop.

The Inmarsat BGAN system

What is BGAN?

The Broadband Global Area Network (BGAN) is a mobile satellite service that offers high-speed data up to 492 kbps and voice telephony. BGAN enables users to access e-mail, corporate networks and the Internet, transfer files and make telephone calls.

The Inmarsat FleetBroadband service

FleetBroadband is a maritime communications service offered in the BGAN system. Based on 3G standards, FleetBroadband provides cost-effective broadband data and voice simultaneously.

Coverage

The Inmarsat® BGAN services are based on geostationary satellites situated above the equator. Each satellite covers a certain area (footprint). The coverage map below shows the footprints of the BGAN system. For updated information on coverage, see Inmarsat’s home page at inmarsat.com.

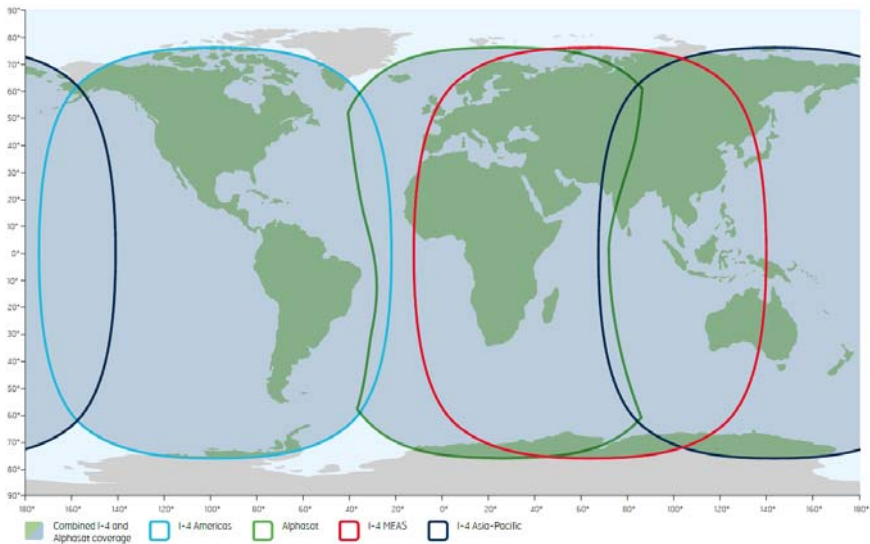

Note

The map above shows Inmarsat’s expectations of coverage, but does not represent a guarantee of service. The availability of service at the edge of coverage areas may fluctuate.

Overview of the BGAN FleetBroadband system

A complete BGAN FleetBroadband system includes the SAILOR FleetBroadband Terminal with connected peripherals, a SAILOR 500 FleetBroadband antenna or a SAILOR 250 FleetBroadband Antenna, the BGAN satellite, and the Satellite Access Station (SAS). The satellites are the connection between your terminal and the SAS, which is the gateway to the worldwide networks (Internet, telephone network, cellular network, etc.).

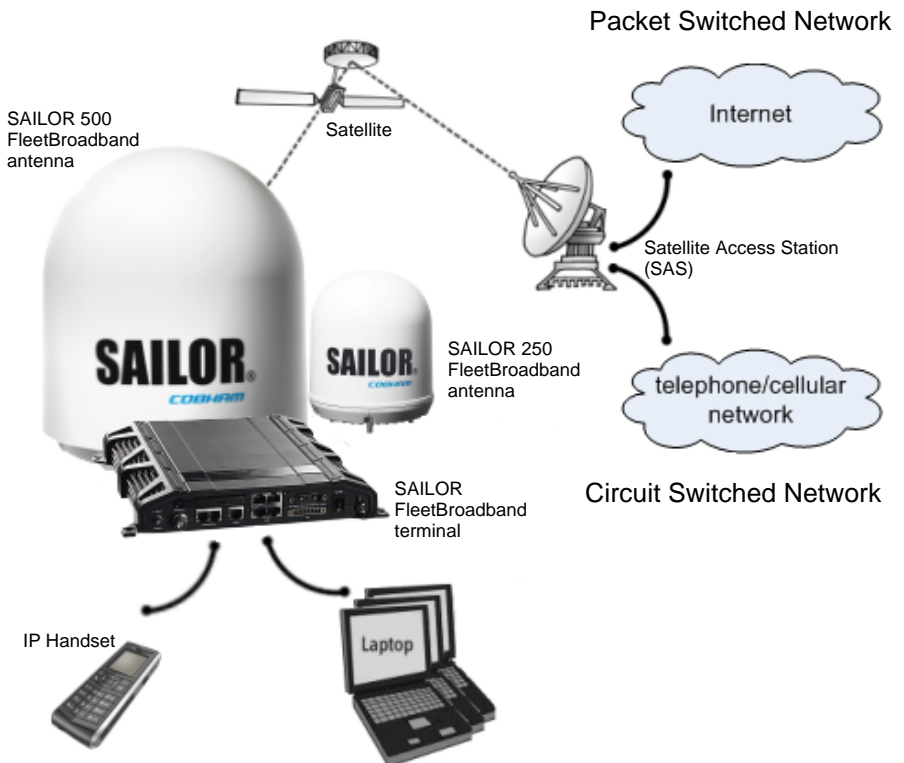

The BGAN services supported by SAILOR FleetBroadband

Supported services

The services currently supported by the SAILOR FleetBroadband comprise:

- A Packet-Switched (PS) connection to the Internet
- A Circuit-Switched (CS) dialed connection for voice, fax or data
- Short Messaging Service (SMS)
- Multi-voice
- Voice Distress

Packet data service

The BGAN network supports different classes of data connection to the Internet.

- Using a **Standard IP** connection several users can share the data connection simultaneously. This type of connection is ideal for e-mail, file transfer, and Internet and intranet access. The user pays for the amount of data sent and received.
- Using a **Streaming IP** connection you get an exclusive high-priority connection that ensures seamless transfer of data. This type of connection is ideal for time critical applications like live video over IP. The 8 and 16 kbps connections are well suited for Voice over IP. The user pays for the duration of the connection (per minute charge).

Note

The BGAN system supports maximum 11 concurrent Packet Switched connections at a time per SAILOR FleetBroadband system.

Circuit-Switched (dialed) service

The following types of circuit-switched connection are available:

- **Standard Voice.** A low-tariff connection for voice only. The voice signal is compressed to 4.0 kbps, which reduces the bandwidth use and consequently the tariff.
- **3.1 kHz Audio.** A high quality connection which can be used for Premium Voice or G3 fax. The signal is uncompressed 3.1 kHz audio, which allows for optimum voice quality. Note that the 3.1 kHz Audio service may have a much higher tariff than Standard Voice.
- **ISDN.** A high quality connection which can be used for voice (3.1 kHz Audio), G4 fax or 64 kbps UDI/RDI data.

SMS service

The BGAN system provides a Short Messaging Service (SMS) for sending and receiving SMS messages to and from the terminal.

Multi-voice service (optional)

Normally, the BGAN system only supports one call at a time per SAILOR FleetBroadband System. When you subscribe to the optional Multi-voice service and enable it in your system, you can have up to 9 concurrent calls.

To use the Multi-voice service you must enable Multi-voice in the web interface of the SAILOR FleetBroadband terminal. For information on how to set up Multi-voice, see *Multi-voice* on page 191.

Voice Distress service (optional)

The Voice Distress service uses FleetBroadband to provide priority call access as soon as the red distress button on the alarm panel is pressed. The caller will then be connected to an operator at one of three Maritime Rescue Coordination Centres (MRCCs) strategically located around the globe.

To use the Voice Distress service you must first have it included in your airtime subscription, acquire a SAILOR 3771 Alarm Panel and use the web

interface of the SAILOR FleetBroadband terminal to enable Voice Distress and assign an IP Handset.

Supplementary services

The BGAN system also provides the following supplementary services:

- Call hold
- Call waiting
- Call forwarding
- Voice mail
- Call barring

Service limitations

SIM lock

The supplier may have locked the SIM card to a specific provider. For further information, contact your supplier.

Limitations in available services

The services available depend on your airtime subscription. Your SIM card may not allow for all the services described in this manual.

For Multi-voice, the maximum number of concurrent calls depends on the terminal type and the available bandwidth and network conditions.

Also, some services may not be available at the edge of coverage areas, i.e. in low elevations.

For further information on coverage, please refer to the Inmarsat home page at inmarsat.com.

Services and interfaces

The following table shows which equipment and interfaces you can use to access the services listed in the left column.

Service	Interface on the terminal		
	Phone/Fax	LAN (PoE)	ISDN
3.1 kHz Audio ^a	Analog telephone	IP handset	ISDN telephone
	G3 Fax machine		G4 Fax machine in G3 mode
Standard Voice	Analog telephone	IP handset	ISDN telephone
Data, UDI ^a or RDI			G4 fax machine or computer with ISDN modem
Data over IP		Computer	
SMS		Computer using web interface	

- a. Notes for SAILOR 250 FleetBroadband: UDI data is not available. In low elevations, < 20°, 3.1 kHz Audio is not available. Refer to *Service limitations* on page 16.

To get started

This chapter describes how to start up the system and make the first call or data session. It has the following sections:

- *Before you start*
- *To start up the terminal*
- *To connect the IP handset*
- *To connect a computer*
- *To enter the SIM PIN for the terminal*
- *To register with the BGAN network*
- *To make the first call*
- *Standard connection to the Internet (default)*

For information on how to install the system, insert SIM card and connect cables, refer to the installation manual for the SAILOR FleetBroadband Systems.

Before you start

Operation at high temperatures



Caution! In very high ambient temperatures, do not touch areas of the terminal that are marked with this symbol.



If the terminal is installed in a location where the ambient temperature may exceed 45°C, we recommend that you place the terminal where unintentional contact is avoided. Note that the maximum allowed ambient temperature is 55°C. If the maximum ambient temperature does not exceed 45°C, the terminal can be placed in a public area.

For further information on installation, refer to the installation manual for the SAILOR FleetBroadband Systems.

Connector panel

The drawings below show the connector panel of each terminal version. The only difference is the Terminal block on the 19" Rack terminal.

Connector panel on SAILOR FleetBroadband terminal:

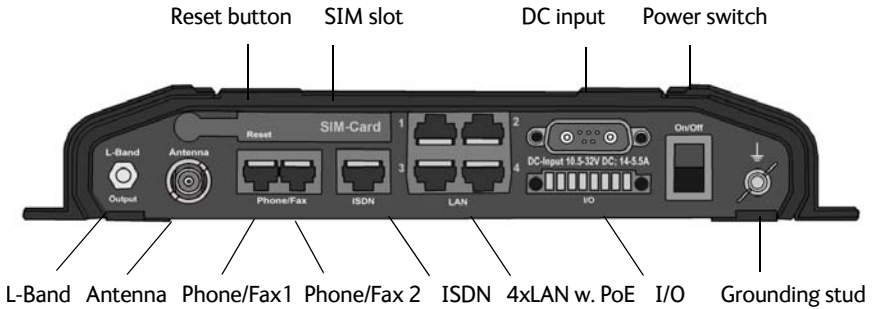

Connector panel on SAILOR FleetBroadband, 19" Rack terminal:

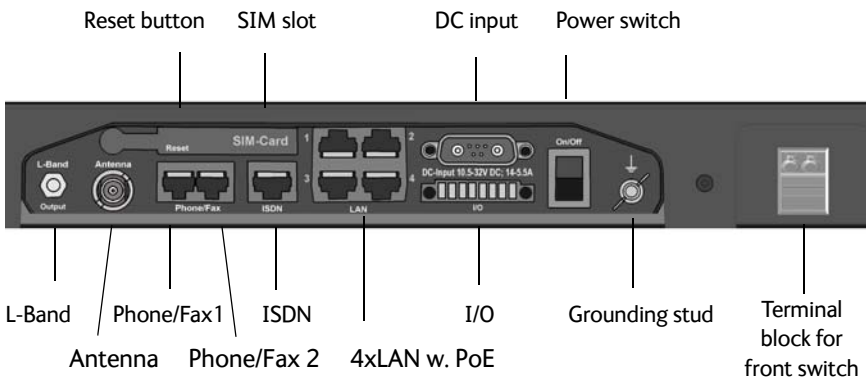

For information on how to connect to each interface, refer to the installation manual for the SAILOR FleetBroadband systems.

To start up the terminal

SIM card

Note that the SAILOR FleetBroadband Terminal requires a SIM card dedicated to FleetBroadband. The terminal can only access the BGAN network when the right type of SIM card is installed. For information on how to insert the SIM card, refer to the installation manual.

To switch on the terminal

To use the Power switch

Note

If you have the 19" Rack variant of the SAILOR FleetBroadband terminal, you can use the on/off switch in the front panel. See the next section *19" Rack terminal: Using the front power switch*.

To switch on the terminal, use the On/Off switch in the connector panel. It normally takes one or two seconds for the terminal to switch on.



19" Rack terminal: Using the front power switch

If you have the 19" Rack variant of the SAILOR FleetBroadband terminal, flip the switch in the front panel to "1" to switch on the terminal.



Note To be able to use the power switch on the front panel, you must leave the On/Off switch in the connector panel in the On position.



To use the ignition system

Normally the ignition function is not used in maritime installations. Instead you may want to use the remote on/off function described in the next section.

If you have connected the ignition system of your vessel to the I/O connector, you may leave the power switch in the “on” position and the terminal will switch on/off when you start/stop the engine of your vessel.

Note | If you have the 19” Rack terminal, you must leave **both** power switches in the “on” position to make use of the ignition function.

When the engine is stopped the terminal is in standby mode. The standby current is max. 15 mA when the ignition is off. For information on how to connect to the Ignition pins in the I/O connector, refer to the installation manual for the SAILOR FleetBroadband System.

You must set up the ignition function in the web interface. For further information, see *To configure the I/O interface* on page 137.

Note | In some cases, the system may reboot after power-on because of the high start-up current.

To use a remote on/off switch

Note | In the 19” Rack version of the terminal the remote on/off function is normally not available, because it is used for the front switch.

If an external switch is connected to the remote on/off pins in the DC connector, you may leave the power switch in the connector panel in the “on” position and use the remote switch to turn the terminal on and off. When the remote switch is off, the terminal is off. However, if you leave the power switch on the terminal in the “on” position, you can always switch the terminal back on with the remote switch. The standby current when the remote switch is off is max. 2 mA. For further information on the remote on/off function, refer to the installation manual for the SAILOR FleetBroadband Systems.

Power up completed

When the terminal is switched on, the Power indicator in the LED panel of the terminal lights green.



You can now access the terminal settings, but the terminal is not ready to make calls or running data sessions until the system is registered on the BGAN network. You may have to enter a SIM PIN before the system can register. For further information, see *To enter the SIM PIN for the terminal* on page 27 and *To register with the BGAN network* on page 30.

To switch off the terminal flip the Power switch back. It takes 5 to 10 seconds to power down the terminal. Alternatively use the ignition or remote on/off function described above.

To connect the IP handset

Power supply (PoE)

The IP Handset is powered from the LAN interface, using Power over Ethernet. The total output power from all 4 interfaces is

- 64 W at 24 V DC power supply
- 32 W at 12 V DC power supply

All interfaces can support devices of power class 1, 2 and 3 (4, 7 and 15.4 Watt), as long as the total power consumption does not exceed the above limits. If the limits are exceeded, the LAN ports are prioritised so that LAN port 1 has the highest priority.

In case of power hold-up (failure on input power), PoE will be turned off completely.

To start up the IP Handset

The following procedure is for the IP Handset from Cobham SATCOM. The procedure may be different for another type of IP handset.

Note

By default, a handset connected to the LAN interface on the terminal is automatically registered in the terminal and assigned the first available local number. For information on how to configure handsets, see *To connect and configure IP handsets* on page 128.

To start up the IP Handset, do as follows:

1. Connect the Ethernet cable from the IP Handset/cradle to one of the LAN (PoE) connectors on the terminal as described in the user manual for the handset.
2. The handset starts up automatically.

When the display shows this symbol  in the upper right corner, the handset is ready to make a call.

If the handset is not ready to make calls, it may be because the BGAN terminal is waiting for a SIM PIN. To check this, enter the handset menu system and select **BGAN > Status > PIN status**.

You can enter the SIM PIN using the IP Handset. For details, see *To enter the SIM PIN using a phone or IP Handset* on page 27.

To connect a computer

Before you connect to the LAN interface

For the LAN interface to work without any further setup, the connected computer must be set up to obtain an IP address and a DNS server address automatically.

To check this on your computer (Windows XP), do as follows:

1. Go to **Start > Settings > Control Panel > Network Connections**.
2. Right-click on the LAN connection you want to use.
3. Select **Properties**.
4. Highlight **Internet Protocol (TCP/IP)**.
5. Click **Properties**.
6. Make sure that the following is selected:
 - Obtain an IP address automatically
 - Obtain DNS server address automatically

To connect a computer to the LAN interface

To connect a computer to the LAN interface, do as follows:

1. Power up your computer.
2. Connect your LAN cable between the network connector on your computer and one of the LAN connectors on the terminal.

3. When the computer and the terminal are ready, check the connection e.g. by accessing the built-in web interface of the terminal with your browser. For further information, see *To access the web interface* on page 79.

You may have to disable the Proxy server settings in your browser. For further information, see *Proxy settings when you access the web interface* on page 78.

For information on how to connect to the Internet, see *Standard connection to the Internet (default)* on page 35.

For information on how to configure the LAN interface on the terminal, see *To configure the LAN interface* on page 104.

To enter the SIM PIN for the terminal

Do you need a SIM PIN?

Depending on your SIM card, you may have to enter a SIM PIN to use the system. Your SIM PIN is supplied with your SIM card. You can enter the PIN using a standard phone or ISDN phone, the IP Handset or the web interface.

Note

Using an Administrator user name and password you can change the PIN and enable or disable the use of a PIN. For further information, see *To set up the use of a SIM PIN in the terminal* on page 180.

For information on how to connect your IP Handset or computer, see *To connect a computer to the LAN interface* on page 26 or *To connect the IP handset* on page 25.

To enter the SIM PIN using a phone or IP Handset

To enter the SIM PIN

If you have a phone connected to the terminal, you can use it to enter the SIM PIN for the terminal at start up.

Do as follows:

- **For an analog or ISDN phone:**
Pick up the phone. When the terminal is waiting for a PIN, you will hear 2 beeps - pause - 2 beeps - etc.
Dial <PIN> followed by #.
When you hear a “busy” tone or a dialing tone, the PIN has been accepted and you can hang up or dial a number.
- **For the IP Handset:**
Select the **BGAN** menu, select **Enter PIN** and enter the administrator user name and password for the terminal. Then enter the PIN for the terminal.
Note that the menu item “Enter PIN” is only available if the terminal is waiting for a PIN.

Wrong SIM PIN

Analog phone or ISDN phone:

If, instead of the busy tone or dialing tone, you continue to hear 2 beeps - pause - 2 beeps - etc., it means the SIM PIN was not accepted. Check that you have the correct PIN and try again.

If a wrong PIN has been entered three times in the terminal, you will hear 3 beeps - pause - 3 beeps - etc. This means you have to enter the PUK (PIN Unblocking Key) provided with your SIM card.

After you have entered the PUK, you must enter a new PIN of your own choice (4 to 8 digits long).

Dial the following:

<PUK> * <New PIN> * <New PIN> followed by # or off-hook key.

Example: If the PUK is 87654321 and the new PIN is 1234, dial
87654321 * 1234 * 1234 followed by # or off-hook key.

If you enter 10 wrong PUKs, the SIM card will no longer be functional. Contact your Airtime Provider for a new SIM card.

IP Handset:

After you have entered the user name and password for the terminal you have 3 attempts to enter the SIM PIN, before you are asked to enter the PUK. The PUK is supplied with the SIM card for your terminal.

Enter the PUK followed by a new PIN of your own choice. The PIN must be from 4 to 8 digits long. If you enter a wrong PUK 10 times, the SIM card will no longer be functional, and you have to contact your Airtime Provider for a new SIM card.

To enter the SIM PIN using the web interface

To enter the SIM PIN

Do as follows:

1. On a computer connected to the terminal, open your browser and enter **http://ut.bgan** or the IP address of the terminal in the address bar (default IP address: `http://192.168.0.1`).

If your SIM card uses a PIN and the PIN has not yet been entered, the web interface will open on the PIN page.

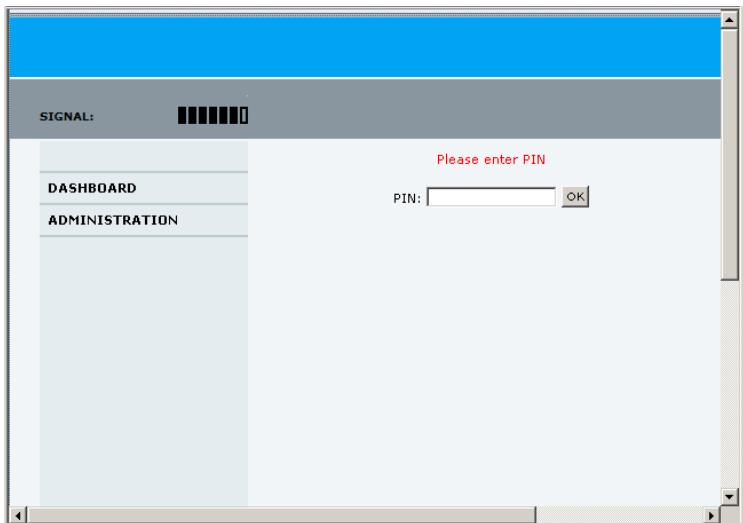

2. Type in the PIN and click **OK**.

When the PIN is accepted, the web interface opens the Dashboard and is ready for use. If the PIN is not accepted, see the next section *Wrong PIN*.

For further information on the web interface refer to *To use the web interface* on page 77.

Wrong PIN

You have 3 attempts to enter the PIN in the web interface, before you are asked to enter the PUK (Pin Unblocking Key). The PUK is supplied with your SIM card.

Enter the PUK followed by a new PIN of your own choice. The PIN must be 4 to 8 digits long.

If you enter a wrong PUK 10 times, the SIM card will no longer be functional, and you have to contact your Airtime Provider for a new SIM card.

To register with the BGAN network

Registration procedure

When the SIM PIN is accepted by the terminal, the SAILOR FleetBroadband System automatically starts the registration procedure on the BGAN network.

You can monitor the registration procedure by looking at the Antenna and Terminal indicators in the LED panel of the terminal.

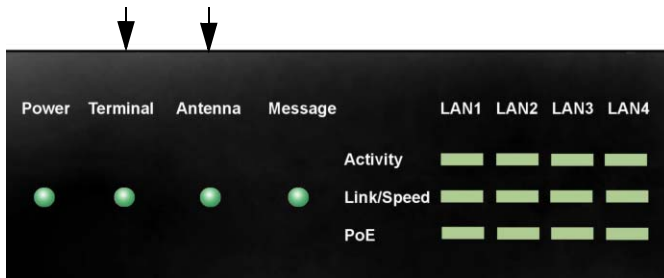

Note that the registration procedure may take several minutes. The table in the next section shows the normal sequence when registering.

LED indications during the registration procedure

This table shows how the startup procedure is signalled with the light indicators. If an error occurs, the indicators will light yellow or red, depending on the severity of the error. For further information on the indicators, see *Light indicators* on page 213.

Status	Antenna indicator	Terminal indicator
The antenna is starting up	Flashing slowly green	Flashing green
The antenna is performing a sky scan	Flashing rapidly green	Flashing green
The antenna is tracking	Steady green	Flashing green
The terminal is registering on the network	Steady green	Flashing green
The system is registered and ready for use.	Steady green	Steady green

Indications in the web interface

The dashboard in the web interface also shows the status during and after registration. To open the web interface, do as follows:

1. On a computer connected to the terminal, open your browser and enter the IP address of the terminal in the address bar (default IP address: `http://192.168.0.1`).

When the system is ready, the **Antenna status** field shows **Tracking** and the **Status** field shows **Ready** (unless a call or data session is active).

2. Click **Refresh** to update the screen.

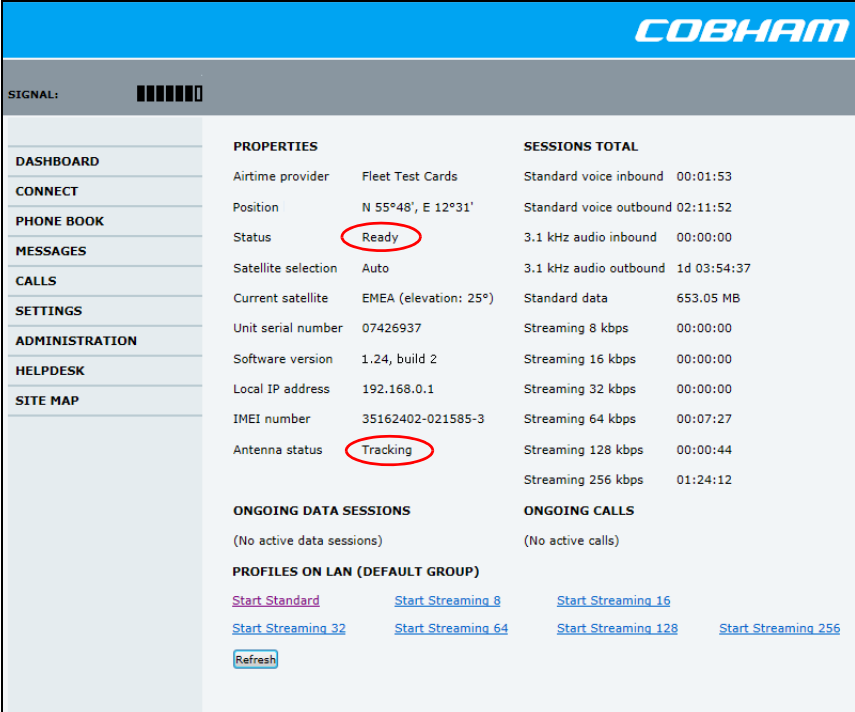

The screenshot shows the COBHAM web interface dashboard. At the top right is the COBHAM logo. Below it is a signal strength indicator labeled 'SIGNAL:'. On the left is a navigation menu with items: DASHBOARD, CONNECT, PHONE BOOK, MESSAGES, CALLS, SETTINGS, ADMINISTRATION, HELPDESK, and SITE MAP. The main content area is divided into three columns. The first column is 'PROPERTIES' with fields: Airtime provider (Fleet Test Cards), Position (N 55°48', E 12°31'), Status (Ready, circled in red), Satellite selection (Auto), Current satellite (EMEA (elevation: 25°)), Unit serial number (07426937), Software version (1.24, build 2), Local IP address (192.168.0.1), IMEI number (35162402-021585-3), and Antenna status (Tracking, circled in red). The second column is 'SESSIONS TOTAL' with rows for Standard voice inbound/outbound, 3.1 kHz audio inbound/outbound, and Standard data, each with a duration. The third column is 'ONGOING DATA SESSIONS' and 'ONGOING CALLS', both showing '(No active data sessions)' and '(No active calls)'. At the bottom, there is a section 'PROFILES ON LAN (DEFAULT GROUP)' with links for Start Standard, Start Streaming 8, Start Streaming 16, Start Streaming 32, Start Streaming 64, Start Streaming 128, and Start Streaming 256. A Refresh button is located at the bottom left of the main content area.

To make the first call

When the Antenna and Terminal indicators in the LED panel on the terminal both light steady green, you are ready to make or receive the first call. The following sections provide a short guide to making calls. For more detailed information, see *To make or receive a phone call* on page 46.

To make a call from the terminal

To make a call from a phone connected to the terminal, dial

00 <country code> <phone number> followed by # or off-hook key.

Example: To call Cobham SATCOM in Denmark (+45 39558800) from an analog phone, dial **00 45 39558800 #**

To make a call to the terminal

Note

By default all phones connected to the terminal will ring on incoming calls. However, you can configure the behaviour of the interfaces using the web interface (see the relevant interface in *To set up the interfaces* on page 103). You can also set up a local exchange function in the terminal so that you can call a specific phone connected to the terminal. See *Setting up the local exchange function* on page 125.

To make a call to a phone connected to the terminal, dial

+ <Mobile number>

- + is the international call prefix¹ used in front of the country code for international calls.
- **Mobile number:** The mobile number of the terminal/handset you are calling. The first part of the number is always 870, which is the “country code” for the BGAN system.

1. The plus sign indicates the code required to dial out of one's country code area, such as 00 in most of Europe, 011 in the United States, and other short codes in other parts of the world.

Example: If you are calling from Denmark and the mobile number for Standard Voice is 870772420567 on your terminal, and you want to make a Standard call to the terminal, dial **00 870 772420567**.

If the mobile numbers are listed in the web interface, you can look them up by selecting **PHONE BOOK > Mobile numbers**. If the numbers are not listed, refer to the documents provided with your airtime subscription. See *To view and edit the mobile numbers* on page 91.

To make a call from one terminal to another

To make a call from one terminal to another, dial **00 <Mobile number>**.

Standard connection to the Internet (default)

Note

This section only describes a Standard Internet connection with default settings on the terminal. For information on other scenarios, see *To connect to the Internet* on page 66.

By default, the terminal does **not** automatically connect to the Internet when you connect your computer or other equipment to the LAN interface. You must activate your connection from the Dashboard in the web interface or from the IP Handset with local number 0501 (master handset).

To activate the connection from a computer (web interface)

To activate the connection from a connected computer, do as follows:

1. Access the web interface by opening your browser and entering **http://ut.bgan** or the IP address of the terminal in the address bar. “http://ut.bgan” translates into the IP address of the terminal (if your computer is set up as described in *Before you connect to the LAN interface* on page 26). The default IP address is 192.168.0.1.
2. Click **Start Standard** under **PROFILES ON LAN** at the bottom of the page.

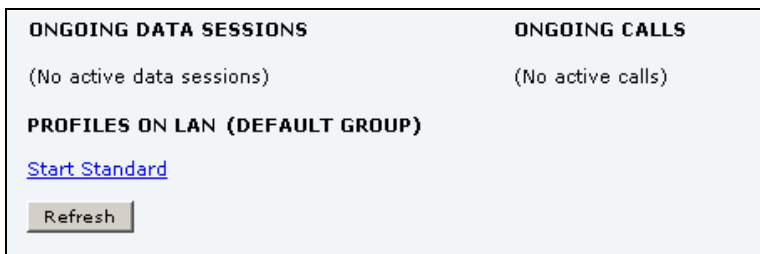

3. Check the connection, e.g. by entering a web site. The field ONGOING DATA SESSIONS will show the IP address for the data session you started.

To activate the connection using the IP Handset (only handset number 0501)

To activate the connection using the IP Handset, do as follows:

1. Connect the IP Handset to one of the LAN ports (preferably port 1). The handset starts up automatically.
2. Select **Menu > BGAN** in the handset.
3. Select **Connect**.
4. Use the left/right keys to find the network user group for the application you want to start.
5. Press **Start** to start the connection.
A confirmation window is displayed.
6. Press **Yes** to continue.
The IP Handset sends a command to the terminal to start the selected connection.
7. Check the connection, e.g. by entering a web site from a connected computer.

To operate the system

This chapter describes how to use the SAILOR FleetBroadband Systems. It has the following sections:

- *General*
- *To use a phone or fax machine*
- *Multi-voice (optional)*
- *Voice Distress (optional)*
- *To use a computer*
- *To use the IP Handset*

This chapter does not describe advanced configuration of interfaces. For this type of information, refer to the “Configure...” sections for the interfaces in Chapter 4, *To use the web interface*.

General

Tools for setup and use

Overview

You can use the **IP Handset** from Cobham SATCOM to view status, use the phone book of the terminal and to enter the PIN, but for enhanced use and for configuration of interfaces, you must connect a computer.

With a computer and a browser, you can use the built-in **web interface** to set up the terminal.

The IP Handset

When you connect the IP Handset to one of the LAN (PoE) connectors on the terminal you can use the handset display and keypad to enter the PIN or to view the status of the terminal.

The menu system in the IP Handset includes the following items for the terminal:

- BGAN menu:
 - Select, start and stop your data connections
 - View C/No (signal strength) for the system
 - View status (“Ready”, “Registering” etc.) for the system
 - View the software version of the terminal
 - Enter the PIN and PUK for the terminal
 - View active events
 - View Position status
- Contacts:
 - Inclusion of the terminal phone book (not editable) in the IP Handset Contacts
- SIP (Session Initiation Protocol):
 - Select/view/configure the SIP profile used for communication with the BGAN terminal
- Date and time:
 - Possibility to use UTC time received from the BGAN satellite

For further information, see the user manual for the IP Handset.

The web interface of the terminal

The web interface is a built-in web server for setup and control of the terminal, using a connected computer with a browser.

Note

You can set up user permissions to limit access to certain parts of the system configuration, see *To set up user permissions* on page 182.

With the web interface you can:

- Enter the SIM PIN for the terminal
- DASHBOARD page:
 - start and stop data sessions
 - view information on calls to/from the terminal
 - view status of the terminal and antenna
 - view properties of the terminal and antenna
- CONNECT page:
 - start and stop data sessions for all network user groups connected to the terminal (requires administrator password)
- PHONE BOOK page:
 - view and edit the phone book
- MESSAGES page:
 - send and receive SMS messages
- CALLS page:
 - view the call log (outgoing, received and missed calls and data)
- SETTINGS page:
 - set up the interfaces of the terminal
 - set up tracking
 - set up call services
 - upload software
 - set up network user groups (requires administrator password)
 - select the satellite to use for connection to the BGAN network

- set the language in the web interface
- ADMINISTRATION page (requires administrator password):
 - set up data limits
 - set up data profiles and traffic flow filters
 - change the SIM PIN for the terminal
 - set up user rights
 - set up remote management and activation
 - set up link monitoring
 - set up restricted dialing
 - set up Multi-voice
 - set up Voice Distress
 - set up NSD mode for combined GX/L-Band operation
 - set up a dual antenna system
 - activate/deactivate RF noise filter for interference from terrestrial mobile systems that operate inside the Inmarsat band (e.g. ATC)
 - change positioning system

For information on how to use the web interface, see *To use the web interface* on page 77.

Services and interfaces

The following table shows which equipment and interfaces you can use to access the services listed in the left column.

Service	Interface on the terminal		
	Phone/Fax	LAN (PoE)	ISDN
3.1 kHz Audio^a	Analog telephone	IP handset	ISDN telephone
	G3 Fax machine		G4 Fax machine in G3 mode
Standard Voice	Analog telephone	IP handset	ISDN telephone
Data, UDI^a or RDI			G4 fax machine or computer with ISDN modem
Data over IP		Computer	
SMS		Computer using web interface	

- a. Notes for SAILOR 250 FleetBroadband: UDI data is not available. In low elevations, < 20°, 3.1 kHz Audio is not available. Refer to *Service limitations* on page 16.

To use a phone or fax machine

Available interfaces

Three types of voice equipment connect to the terminal:

Standard analog phone or G3 fax machine: The terminal has two phone connectors for connecting standard analog phones or fax machines.

IP handset: The terminal has four LAN connectors with Power over Ethernet for connecting IP handsets or other IP equipment. For details on the features and functions of the IP Handset, refer to the user manual for the handset.

ISDN phone or G4 fax machine: The terminal has one ISDN connector for connecting an ISDN phone, a modem or a fax machine. Note that only SAILOR 500 FleetBroadband supports G4 fax (UDI).

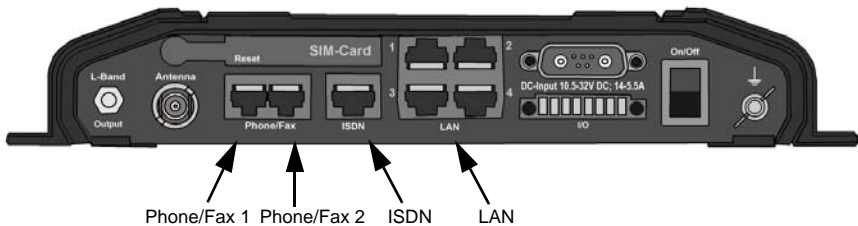

For information on how to connect to the interfaces, see the installation manual for the SAILOR FleetBroadband Systems.

To select the call type

Definition

The phone connection can use one of the following call types:

- **Standard Voice**, which is a low-tariff voice connection compressed to 4.0 kbps
- **3.1 kHz Audio**, which is a high quality connection used for Premium Voice or G.3 fax
- **UDI or RDI** (only on ISDN interface), which is used for G4 fax or data

In the web interface you can set up which type of connection to use by default when you make or receive a call from the Phone/Fax or ISDN interface or from an IP handset connected to the LAN interface. Standard Voice is selected by default. When you connect a fax to the Phone/Fax interface you must use 3.1 kHz Audio.

Example: If you always have a fax connected to the same Phone/Fax interface you can set this interface to 3.1 kHz Audio only. This will mean that if an incoming Standard Voice call is received, this Phone/Fax interface will not ring.

When you connect a G4 fax or a modem to the ISDN interface you must use UDI.

Note

UDI and RDI are **not available** with the SAILOR 250 FleetBroadband system, so you cannot connect a G4 fax machine nor a modem to the ISDN interface on the SAILOR 250 FleetBroadband system.

To select the default outgoing call type

To select the default call type for outgoing calls, do as follows:

- **ISDN.** Select the call type in the web interface under **SETTINGS > ISDN**.
For further information, see *To configure the ISDN interface* on page 114.
- **Phone/Fax.** Select the call type for each port in the web interface under **SETTINGS > Phone/Fax**. For further information, see *To configure the Phone/Fax interface* on page 112.
- **IP handset.** Select the call type for each handset in the web interface under **SETTINGS > IP Handset > Call settings**. For further information, see *To set the call types for IP handsets* on page 130.

To override the default outgoing call type

To override the default setting for a specific outgoing call, do as follows:

- To use **Standard Voice** for the call, dial **1*** before the number.
- To use **3.1 kHz Audio** for the call, dial **2*** before the number.

Example: To make a call to Cobham SATCOM in Denmark (+45 39558800) forcing the connection to use Standard Voice, dial **1* 0045 39558800** followed by **#** if you are calling from an analog or ISDN phone, or off-hook key if you are calling from an IP handset.

Note

This will not change the default call type, only the type used for the ongoing call.

Phone numbers for incoming calls

The mobile numbers for your system are listed in your airtime subscription. For example, you may have

- 1 number for Standard Voice
- 1 number for 3.1 kHz Audio

- 1 number for UDI data
- 1 number for RDI data

If you have subscribed to the optional Multi-voice feature you may also have Additional numbers, which can be assigned to individual handsets. For further information, see *Additional numbers for Multi-voice* on page 61.

Note

The call type you are using must be selected in the web interface (refer to the next section).

If the mobile numbers are listed in the web interface, you can look them up as follows:

Connect a computer, access the web interface and select **PHONE BOOK > Mobile numbers**. For further information, see *To view and edit the mobile numbers* on page 91.

For information on how to make a call to the terminal, see *To make a call to the terminal* on page 48.

To select the incoming call type

To select which call types are accepted for an incoming call, use a computer and the web interface. If you are using Multi-voice, see *Handset contexts with additional numbers* on page 59.

- **ISDN**. Select the call type under **SETTINGS > ISDN**.
For further information, see *To configure the ISDN interface* on page 114.
- **Phone/Fax**. Select the call type for each port under **SETTINGS > Phone/Fax**.
For further details, see *To configure the Phone/Fax interface* on page 112.
- **IP handset**. Select the call type for each handset in the web interface under **SETTINGS > IP Handset > Call settings**. For further information, see *To set the call types for IP handsets* on page 130.

To make or receive a phone call

To make a call

Note | If one call is already active, you can only make a second call if you have Multi-voice in your subscription and it is enabled. For details on how to set up Multi-voice using the web interface, see *Multi-voice* on page 191.

You have different options to make a call:

- **Short Dial.** If the number is in the phone book of the terminal, you can use the Short Dial number, which is found in the first column of the phone book in the web interface. See *Short dial* on page 89.

Simply dial **00 <Short Dial>** followed by **#** or off-hook key.

Example: To call entry number 4 in the phone book, dial **004** followed by **#** or off-hook key.

- **Manual Dial.** To make a call, dial **00 <country code> <phone number>** followed by **#** or off-hook key.

Example: To call Cobham SATCOM in Denmark (+45 39558800) from an analog or ISDN phone, dial **00 45 39558800 #**

- **Call from phone book or call log** (only IP Handset from Cobham SATCOM).
 - Enter the phone book of the IP Handset, scroll to the wanted number and press the off-hook key, or
 - press the off-hook key from the main screen to display the latest calls in the call log. Then scroll to the wanted number and press the off-hook key again.

Note that this is the call log of the IP Handset, not of the terminal.

If there was an error establishing the connection, refer to the *Troubleshooting Guide* on page 206.

If you are using the IP Handset, the handset may show an error message. Depending on the type of error, the web interface may also show an error message. See *To view the Event list or the Event log* on page 198.

To receive a call

By default, all devices connected to the Phone/Fax interface, the ISDN interface or the LAN (PoE) interface will ring when one of the mobile numbers is called. Note, however, that this depends on the call type settings and on the local exchange settings. Refer to *To select the incoming call type* on page 45 and *Setting up the local exchange function* on page 125.

If you are using Multi-voice there are more options for setting up how to handle incoming calls. See *Handset contexts with additional numbers* on page 59.

Call log

Information of outgoing calls, received calls and missed calls is stored in the call log of the terminal. You can view the call log in the web interface under **CALLS**. For further information, see *To view the lists of calls and data sessions* on page 95.

To make a call to the terminal

Note

By default all phones connected to the terminal will ring on incoming calls. However, this depends on the configuration of the interfaces in the terminal. See

- *To select the call type* on page 43.
- *Using the local exchange* on page 49.
- If you are using Multi-voice, see *Handset contexts with additional numbers* on page 59.

To make a call to a phone connected to the terminal, dial

+ <Mobile number>

- + is the international call prefix¹ used in front of the country code for international calls.
- **Mobile number.** The first part of the mobile number is always 870, which is the “country code” for the BGAN system. If the mobile numbers are listed in the web interface, you can look them up as follows:

Connect a computer, access the web interface and select **PHONE BOOK > Mobile numbers**. For further information, see *To view and edit the mobile numbers* on page 91.

If the mobile numbers are not available in the web interface, refer to the documents included with your airtime subscription.

1. The plus sign indicates the code required to dial out of one's country code area, such as 00 in most of Europe, 011 in the United States, and other short codes in other parts of the world.

Using the local exchange

Before you can use the local exchange, you must enable it in the web interface of the terminal. For information on how to set up the local exchange function, see *Setting up the local exchange function* on page 125.

Note | The Local exchange function is not available if you have enabled Multi-voice.

With local exchange enabled, do as follows to call a specific handset:

1. Call the mobile number of the terminal.
For details, see the previous section.
2. Listen to the recorded message.
You now have three options:
 - If you know the local number of the phone, dial the number followed by #. **Example:** To call phone number 0301, dial **0301 #**. Your call is then transferred to phone number 0301.
 - If you don't know the number of the phone, you can call the default phone by dialing *.
 - If you dial nothing, you are transferred to the default phone after a time-out period.

To receive a voice mail message

If a call to the SAILOR FleetBroadband system is not answered the caller can leave a voice mail message with Inmarsat's voice mail service. Then an SMS is sent to the SAILOR FleetBroadband messaging system to alert you that there is a voice message. The SMS has the contents:

- Number called from
- Date and time the voice mail message has been received
- Number to call to listen to the voice mail message

To see that a new SMS has arrived you open the web interface. For further details see *To receive a message* on page 99.

To make local phone calls

You can make local calls between various phones connected to the terminal.

Local phone numbers always start with 0.

Note Remember the “0” at the start when you dial a local phone number. If you accidentally dial a 3-digit number, you may get one of Inmarsat’s short dial numbers instead of a local number.

For an overview of the numbers assigned to each type of interface, see *Local numbers and special-purpose numbers* in the next section.

To make a local call, dial **<local number>** followed by **#** or off-hook key.

Note If you are using local numbers for ISDN devices, the numbers must be programmed in the devices. For further information refer to the documentation for your ISDN device.

Local numbers for IP handsets must also be programmed in the IP handsets. However, by default, the IP handsets are automatically assigned the first available local number in the terminal.

Dialing functions

Local numbers and special-purpose numbers

There are a number of dialing functions available in the terminal. The following list shows the allocated special-purpose numbers for the terminal.

Number	Function
0 * followed by # or off-hook key	Redial last called number on this interface.
00 * followed by # or off-hook key	Redial last answered call on this interface. Note: If the last answered number is unlisted, you are not allowed to dial back.
00 followed by one of the numbers 1-199 and # or off-hook key	Short dial phone numbers in phone book.
0300 followed by # or off-hook key	Local call broadcast to both analog phones.
0 followed by one of the numbers 301-302 and # or off-hook key	Local call to analog phone.
0400 followed by # or off-hook key	Local call broadcast to all ISDN phones.
0 followed by one of the numbers 401-402 and # or off-hook key	Local call to ISDN phone.
0500 followed by # or off-hook key	Local call broadcast to all IP handsets.
0 followed by one of the numbers 501-516 and # or off-hook key	Local call to IP handset.
0900 followed by # or off-hook key	Local call broadcast to all phones.

Dialing prefixes

Apart from the numbers above, the terminal uses the following dialing prefixes:

- **1*** before the phone number will force the connection to use **Standard Voice**.
- **2*** before the phone number will force the connection to use **3.1 kHz Audio**.
- **#31#** before the phone number will hide the caller's phone number to the recipient.
- ***31#** before the phone number will show the caller's phone number to the recipient where it would otherwise be hidden, e.g. because the number is an ex-directory number.
- For analog 2-wire telephones, use the R key during a call to get access to a supplementary services function. The supplementary services functions supported by the terminal are described in the following sections.

To handle waiting calls

During a call, if a second party tries to call you, you may hear a Call Waiting indication. The Call Waiting indication is two beeps and a pause of 3 seconds, then two beeps again etc. If no action is taken, the waiting call is released.

In the web interface you can enable or disable the call waiting indication. For further information, see *Call waiting* on page 122.

Note Different types of phone have different methods/keys for the functions listed below. If you have another type of phone than the ones listed below, refer to the documentation for your phone/handset.

Analog 2-wire phones with R key: When you receive a Call Waiting indication, you have the following options:

If you want to:	Do as follows (standard 2-wire phone):
Clear the current call, and accept the waiting call.	Press R 1 #
Hold the current call, and accept the waiting call.	Press R 2 #
Ignore the waiting call.	Take no action.
Reject the waiting call.	Press R 0 #

To hold a call

During a call, you may place the initial call on hold while another call is made.

Note

Different types of phone have different methods/keys for the functions listed below. If you have another type of phone than the ones listed below, refer to the documentation for your phone/handset.

IP Handset from Cobham SATCOM:

Select **Options > Hold** in the IP Handset. For further details, refer to the section “Handling calls” in the user manual for the IP Handset.

Analog 2-wire phones with R key:

If you want to:	Do as follows (standard 2-wire phone):
Place a call on hold.	Press R 2 # .
Place the existing call on hold and establish a new call.	Press R and dial the second phone number followed by # .
Shuttle between the two calls.	Press R 2 # (irrespective of whether the second call was acquired using Call Hold or acceptance of Call Waiting.)
Clear the held call, if no waiting call exists.	Press R 0 # .
Clear an active call and return to the held call.	Press R 1 # . Note that this is only possible if no waiting call exists.

To transfer a call

When you receive a call, you can transfer this call to another phone connected to the terminal.

Note

Different types of phone have different methods/keys for the functions listed below. If you have another type of phone than the ones listed below, refer to the documentation for your phone/handset.

IP Handset from Cobham SATCOM:

Select **Options > Transfer** in the IP Handset. For further details, refer to the section “Handling calls” in the user manual for the IP Handset.

Analog 2-wire phones with R key:

Do as follows to transfer a call:

1. Press **R 4 * <local number> #**.
The phone with the local number you dialed starts to ring.
2. You now have two options.
 - Hang up. The phone or headset you transferred the call to continues to ring. When the call is answered, a connection is established between the initial caller and the new recipient.
 - Do not hang up. When the new recipient answers, you can have a conversation before you hang up. When you hang up, the call is handed over to the initial caller.

To send or receive a fax message

To handle delays

When you send or receive fax messages over satellite, both fax units must be able to handle longer delays without timing out. Some fax machines have an Overseas mode, which enables the unit to handle the long delays.

To send a fax message from the terminal

Note

If the default setting in the web interface is not 3.1 kHz Audio, you can dial 2 * before the number, to force the connection to use 3.1 kHz Audio. For further information, see *To override the default outgoing call type* on page 44.

The fax machine must be connected to the Phone/Fax interface or the ISDN interface of the terminal. Refer to the installation manual.

3.1 kHz Audio must be used for an analog fax machine. Refer to *To select the default outgoing call type* on page 44.

UDI must be used for an ISDN G4 fax machine. Note that this is not possible in a SAILOR 250 FleetBroadband system. Refer to *To configure the ISDN interface* on page 114.

To send a fax from a fax machine connected to the terminal, dial
00 <country code> <phone number> #

Example: To send a fax to Cobham SATCOM in Denmark (+45 39558888), dial **00 45 39558888 #**

To send a fax message to the terminal

To send a fax message to the terminal, dial

+ <Mobile number> #

- + is the international call prefix¹ used in front of the country code for international calls.
- **Mobile number.** The first part of the mobile number is always 870, which is the “country code” for the BGAN system. Use the 3.1 kHz mobile number if you are calling a G3 fax and the UDI number if you are

calling an ISDN G4 fax connected to the terminal. If the mobile numbers are listed in the web interface, you can look them up as follows: Connect a computer, access the web interface and select **PHONE BOOK > Mobile numbers**. For further information, see *To view and edit the mobile numbers* on page 91.

If the mobile numbers are not available in the web interface, see your airtime subscription.

To receive a fax message

An analog fax machine connected to the terminal can only receive a fax with 3.1 kHz Audio. Refer to *To select the incoming call type* on page 45.

An ISDN G4 fax machine connected to the SAILOR 500 FleetBroadband terminal can only receive a fax with UDI (unless it is in G3 mode). SAILOR 250 FleetBroadband does not support UDI and cannot be used with G4 fax.

-
1. The plus sign indicates the code required to dial out of one's country code area, such as 00 in most of Europe, 011 in the United States, and other short codes in other parts of the world.

Multi-voice (optional)

You can add Multi-voice to your airtime subscription, enabling you to have up to 9 simultaneous calls. You can subscribe to Multi-voice with or without additional numbers.

Note You must have Multi-voice in your airtime subscription, IP Handset software version minimum 1.13 and terminal software version minimum 1.15, in order to support the Multi-voice function.

To enable Multi-voice, do as follows:

1. Enter the web interface of your terminal.
2. Select **Administration > Multi-voice**.
3. Enable Multi-voice.

You are now ready to use Multi-voice. See *Rules for concurrent calls* below.

Note If you have additional numbers in your airtime subscription, you must set up how the system should use them. See the sections *Handset contexts with additional numbers* on page 59 and *Additional numbers for Multi-voice* on page 61.

For details on how to set up Multi-voice using the web interface, see *Multi-voice* on page 191.

Rules for concurrent calls

- **First call initiated:** You can use **any connected handset** and **any call type** for incoming as well as outgoing calls.
- **Second and subsequent calls:** You can **only use handsets connected to the LAN interface** for calls initiated/received while another call is active. The call type for the second and subsequent calls is **always Standard Voice**.

Note If your system includes Voice Distress: Distress and Urgency calls to and from the Distress IP Handset always come through.

Handset contexts with additional numbers

Calls to the terminal are treated differently depending on the handset context. If additional numbers are used, there are 3 possible handset contexts, which are explained in this section:

- Call type groups
- Directly assigned handsets
- Unassigned handsets

The handsets are called using one of the mobile numbers received from your airtime provider.

Call type groups

The handsets are called using one of the mobile numbers for either Standard Voice or 3.1 kHz audio. All handsets in a group will ring when the belonging number is called.

For information on how to associate a handset with a group, see

- *To set the call types for IP handsets on page 130*
- *To configure the Phone/Fax interface on page 112*
- *To configure the ISDN interface on page 114*

Example of call type groups:

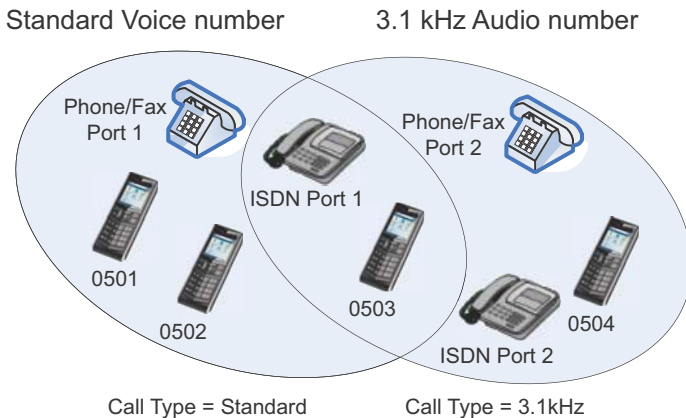

Directly assigned handsets

The mobile numbers are assigned to individual handsets. Only the assigned handset will ring when the belonging number is called.

Note

To use this feature you must have additional numbers in your airtime subscription and enable the use of additional numbers in the web interface. Then you can assign the numbers to individual handsets. For details on additional numbers, see *Additional numbers for Multi-voice* on page 61.

For information on how to assign a number to a handset, see

- To set the call types for IP handsets on page 130
- To configure the Phone/Fax interface on page 112
- To configure the ISDN interface on page 114

Example of directly assigned handsets:



Note that you can also assign the call type numbers directly (in the example above, the Standard Voice number is assigned to IP handset number 0501). If you do so, be aware that only the assigned handset can receive a call to this number. The handset connected to Phone port 1 and the IP handset no. 0501 are each assigned an additional number. For details on additional numbers, see *Additional numbers for Multi-voice* on page 61.

Unassigned handsets

These are IP handsets that are not assigned a number, and that do not belong to a call type group. Use this handset context if you want to create a group of IP handsets that can be called together. All unassigned IP handsets will ring when you call a mobile number which has not been assigned to a handset.

To make an IP handset unassigned, clear all call types and the **Assigned number** field when setting up the handsets in the web interface. See *To set the call types for IP handsets* on page 130.

Example of unassigned handsets

Call to a mobile number which is in the subscription but not assigned to any handset

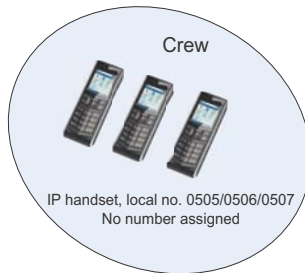

Additional numbers for Multi-voice

Note

You must have Multi-voice with additional numbers in your airtime subscription to be able to use this feature.

In addition to the phone numbers for incoming Standard Voice, 3.1 kHz Audio and UDI/RDI, your subscription may include extra phone numbers that can be assigned to specific handsets. If you want to use the additional phone numbers in your subscription, you must set up the following in the web interface:

- Enable the use of additional numbers in the web interface under **ADMINISTRATION > Multi-voice**. See *Multi-voice* on page 191.
- Add the additional numbers from your airtime subscription under **PHONE BOOK > MOBILE NUMBERS > ADDITIONAL NUMBERS**.
- Assign the numbers to handsets. Depending on the handset interface you want to use, see *To configure the Phone/Fax interface* on page 112, *To configure the ISDN interface* on page 114 and/or *To set the call types for IP handsets* on page 130.

Note about billing

Note that handsets using the 2-wire or ISDN interface cannot be billed individually but are always billed against the primary MSISDN (the terminal's mobile number for Standard voice or 3.1 kHz Audio).

Voice Distress (optional)

With the Voice Distress feature you can make Distress and Urgency calls using the FleetBroadband service.

Note Your airtime subscription must include Voice Distress and your FleetBroadband system must be set up for Voice Distress to be able to use this feature. See *Voice Distress* on page 192.

The software version of the IP Handset used for Distress must be at least version 1.12, in order to support the Voice Distress function.

The Voice Distress system includes a FleetBroadband system, a SAILOR 3771 Alarm Panel and an IP Handset.

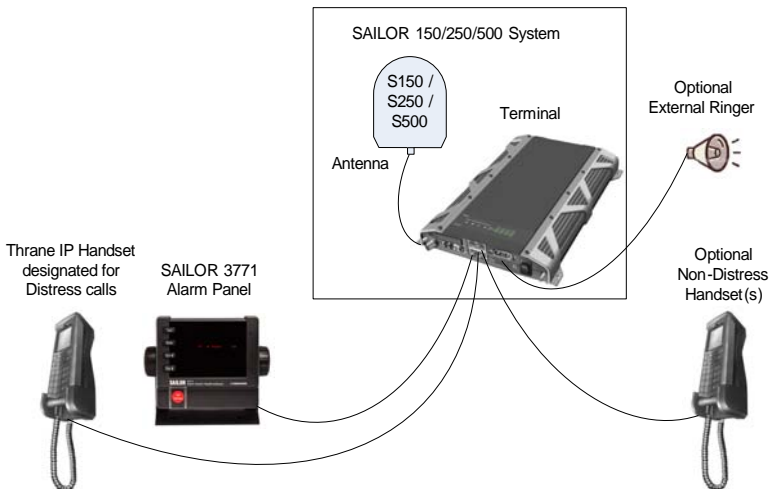

To make a Distress call: Push and hold the red button on the alarm panel for 5 seconds. When the Distress IP Handset rings, pick up the phone. You are now put through to the nearest rescue centre. Follow the procedure for Voice Distress calls.

For details on the Voice Distress system and how to make a Distress call, see the Voice Distress (Non-SOLAS) User manual, 98-133687.

To use a computer

Interfaces

The terminal has four LAN connectors for computers, IP Handsets or other LAN equipment.

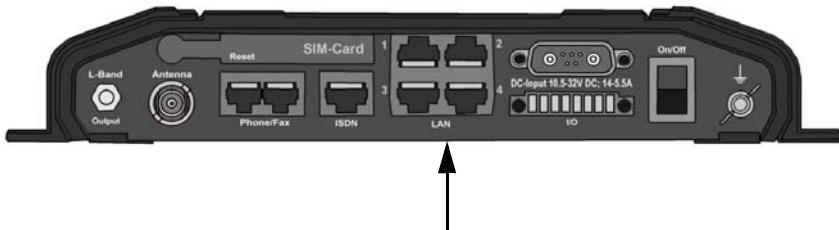

For information on how to connect to the interfaces, see the installation manual for the SAILOR FleetBroadband Systems.

Router function

The terminal has a router function which routes traffic between the local network connected to the terminal and up to 11 network connections or PDP contexts on the BGAN network.

The router contains NAT (Network Address Translation) which allows you to share a public IP address between a number of local network users.

For further information on network management, see *To manage LAN network users* on page 142.

Standard IP or Streaming IP on LAN

The BGAN network supports different classes of data connection to the Internet. The main classes are Standard IP and Streaming IP.

- Using a **Standard IP** connection, several users can share the data connection simultaneously. This type of connection is ideal for TCP/IP

traffic such as e-mail, file transfer, and Internet and intranet access. The user pays for the amount of data sent and received.

- Using a **Streaming IP** connection, you get an exclusive, high-priority connection, that ensures seamless transfer of data. This type of connection is ideal for time critical applications like live video over IP. The 8 and 16 kbps connections are well suited for Voice over IP. The user pays for the duration of the connection.

Note

For optimum performance it is important that you select the right traffic class when defining profiles for your connection.

You can set up various types of connection using the profiles and traffic flow filters. For further information, see *To use profiles* on page 171 and *To use traffic flow filters* on page 176.

To work with network user groups

The LAN users of the SAILOR FleetBroadband system can be organized in network user groups with different setup and different access rights.

The network user group you belong to is determined by one or more of the following:

- the LAN port you connect to
- the IP address of the device you are using
- the MAC address of the device you are using

Non-administrator users can only see and start/stop profiles configured for their own network user group.

Using the web interface and administrator password you can configure the network user groups and network devices. For further information, see *To manage LAN network users* on page 142.

To connect to the Internet

Default setup

By default, any IP device that is connected to the terminal belongs to the **Default** network user group. It uses a Standard shared IP connection, which you must manually activate from the web interface. For further information on network user groups, see *To manage LAN network users* on page 142.

To access your data sessions

Data sessions available for the current user are displayed under **PROFILES ON LAN** or **STREAMING PROFILES ON LAN** at the bottom of the **DASHBOARD**.

Note

To manage data sessions for all users you need an administrator password. For further information, see *To start and stop data sessions for other user groups* on page 157.

ONGOING DATA SESSIONS	ONGOING CALLS
(No active data sessions)	(No active calls)
PROFILES ON LAN (DEFAULT GROUP)	
Start Standard	
<input type="button" value="Refresh"/>	

- Primary profiles are listed in the left side and secondary profiles (if any) are listed to the right.
- Profiles that are currently active are displayed as a link with the text “Stop <name of profile>”.
- Profiles ready to be activated are displayed as a link with the text “Start <name of profile>”.

Start/stop Standard IP on the LAN interface

By default, Standard IP is not automatically activated on the terminal. If you want Standard IP to be automatically activated at start-up, the administrator can enable automatic activation under **SETTINGS > LAN > Network user groups**.

When automatic activation is disabled in the Network user groups page, you can manually start/stop your Standard IP profile from the Dashboard: Click **Start <name of profile>** or **Stop <name of profile>** under **PROFILES ON LAN** at the bottom of the page.

ONGOING DATA SESSIONS	ONGOING CALLS
(No active data sessions)	(No active calls)
PROFILES ON LAN (DEFAULT GROUP)	
Start Standard	
<input type="button" value="Refresh"/>	

Start/stop Streaming IP on the LAN interface

To start or stop a Streaming session, click the link with the name of your Streaming profile under **STREAMING PROFILES ON LAN** at the bottom of the **DASHBOARD**.

Note

The Streaming link is only available if your network user group includes a Streaming profile. See *To edit a network user group* on page 145.

ONGOING DATA SESSIONS	ONGOING CALLS
(No active data sessions)	(No active calls)
STREAMING PROFILES ON LAN (GROUP 0)	
Start Streaming 128	
<input type="button" value="Refresh"/>	

Important

If you have selected and started a Streaming connection as your primary profile, the LAN interface will be running a Streaming connection until you stop it or disconnect the interface.

For information on setup of the network user groups, see *To manage LAN network users* on page 142. For information on how to set up a profile, see *To use profiles* on page 171.

Note

You may not be able to establish the fastest Streaming connection if you are located close to the edges of the satellite beam. For further information on coverage, please refer to Inmarsat's web site www.inmarsat.com.

The SAILOR 250 FleetBroadband system supports 8, 16, 32, 64 and 128 kbps Streaming.

The SAILOR 500 FleetBroadband system supports 8, 16, 32, 64, 128 and 256 kbps Streaming.

To access the terminal from a remote location

To prepare the terminal for remote management

There are three steps you must go through before you can access the terminal from a remote location:

1. Set up the terminal for control from a remote location as described in *Remote management* on page 184.
2. Activate a data connection in one of the following ways:
 - Remote start of a data connection with an SMS, see *Remote activation* on page 186 and *To activate a data connection with an SMS* below.
 - Automatic activation of a Standard data connection, see step 11 on page 148 in *To set up the network user groups*.
 - Manual activation of a data connection, see *Start/stop Standard IP on the LAN interface* on page 67.
3. Note the terminal's external IP address, found in one of the following ways:
 - If you are using SMS activation, you will receive an SMS with the IP address.
 - Otherwise, connect a computer locally to the terminal and start the web interface. The IP address of the terminal is shown in the Dashboard under ONGOING DATA SESSIONS (in parenthesis).

This is the IP address you must use afterwards to access the terminal.

Note

If Static IP is included in your airtime subscription, we recommend using this static public IP address for the terminal in order to provide easy access to the terminal. For information on how to set up the terminal to use the static IP address from your subscription, refer to step 7 on page 147 in the section *To edit a network user group*.

To activate a data connection with an SMS

To be able to activate a data connection on the terminal from a remote location, the terminal must be set up as described in *Remote activation* on page 186.

Send an SMS to the mobile number of the terminal. The activation SMS must have the following format for activating and deactivating a connection:

- `ACTIVATE <name of network user group> : <name of profile>
<password>`
- `DEACTIVATE <name of network user group> : <name of profile>
<password>`

For details on network user groups see *To set up the network user groups* on page 144.

Activation	SMS examples
Standard data connection in the Default network user group	<code>ACTIVATE default: standard 1234567890</code>
Streaming 32 connection in the network user group Group 0	<code>DEACTIVATE Group 0: streaming 32 1234567890</code>

To access the terminal using web interface

After you have prepared the terminal as described in the previous sections, do as follows to access it:

1. Make sure your remote computer has access to the Internet.
2. On the remote computer, open your web browser.
3. Enter the IP address of the terminal followed by a colon and the port number

http://<ip address>:<incoming port>.

- <ip address> is the address from step 3 above.
- <incoming port> is the port you defined in *Remote management* on page 184.

Example: If the IP address of the terminal is 161.30.180.12 and the incoming port number defined in the Remote management page in the web interface is 8080, enter
http://161.30.180.12:8080.

You should now be connected to the built-in web interface of the terminal from your remote computer.

To access the terminal using AT commands

After you have prepared the terminal as described in the previous sections, do as follows to access it:

1. Make sure your remote computer has access to the Internet.
2. On the remote computer, start a Telnet session.
3. Select TCP/IP and type in the IP address and port number.
The IP address is the external IP address of the terminal (see step 3 on page 69).
The port number is the number defined in the Remote management page under AT commands (see page 184).
4. When the connection is established, type in your AT commands.

To use PPPoE (Point-to-Point Protocol over Ethernet)

Overview

You can establish a PPPoE connection to the BGAN network using the SAILOR FleetBroadband system. Use PPPoE if you want to control your connection independently of the web interface and the IP Handset.

Possible applications are:

- Connect a router
- Connect broadcast equipment, optionally through a PC
- Establish a Pico cell for the use of cell phones

The following drawing shows connections managed through PPPoE and web interface respectively.

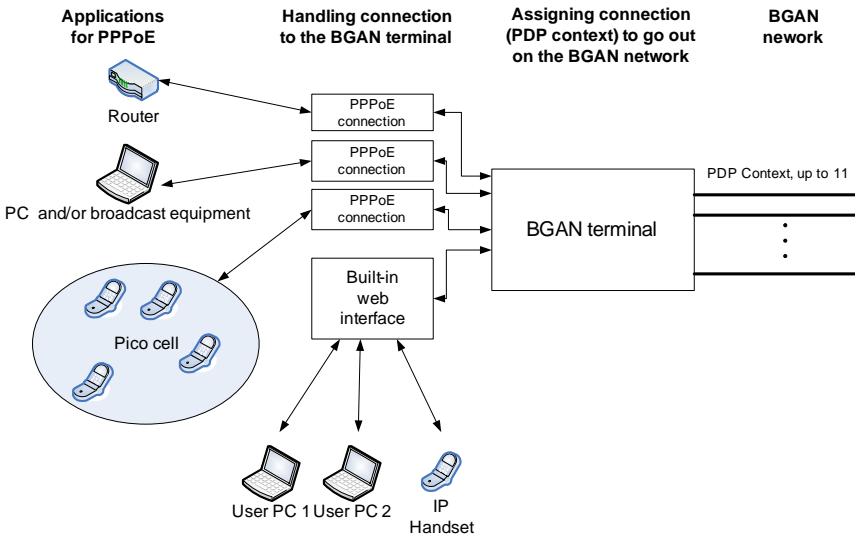

To configure the connected equipment for PPPoE

To use PPPoE with your SAILOR FleetBroadband system, first enable PPPoE in your terminal. Refer to *To enable PPPoE (Point-to-Point Protocol over Ethernet)* on page 109.

After you have enabled PPPoE in the terminal, you must configure your equipment.

How to do this depends on the type of equipment. Refer to the user documentation of the equipment. As a minimum, you need to configure the following parameters in your equipment in order to make PPPoE work with the terminal:

- User name and password.

The user name and password can be left blank (or insert user name: **void** and password: **void**). Then the registration on the Access Point is most commonly done in such a way that the data connection is established with a dynamic IP address from the airtime provider.

To request a static IP (if subscribed to) from the Access Point you must type in the user name and password from your airtime subscription.

Note for MAC OS: User name and password are required. Use user name **void** and password **void**. This works for some ISPs. Contact your airtime provider for further information.

- For setups that have a check box for “Enable LCP extensions”, deselect this.

No further configuration is needed to make a Standard IP data connection to the Internet.

See the next page for information on how to configure specific services for your PPPoE connection.

If you need a certain service, for example a Streaming class, you must type in a specified text string when asked for a service name. The following table shows the service names supported by the terminal.

Text to type in the Service Name field	Function
(Blank)	Initiates a Primary Standard Data connection (default)
XBB:BACKGROUND	Initiates a Primary Standard Data connection (Same as blank!)
XBB:STREAM8K	Initiates a Primary Streaming 8 kbps connection
XBB:STREAM16K	Initiates a Primary Streaming 16 kbps connection
XBB:STREAM32K	Initiates a Primary Streaming 32 kbps connection
XBB:STREAM64K	Initiates a Primary Streaming 64 kbps connection
XBB:STREAM128K	Initiates a Primary Streaming 128 kbps connection
XBB:STREAM256K	Initiates a Primary Streaming 256 kbps connection
XBB:<AT String>	This allows the PPPoE clients to enter a full AT context activation string. Examples: XBB:AT+CGDCONT=1,ip,"bgan.inmarsat.com" XBB:AT+CGEQREQ=1,1,64,64,64,64

For a list of supported AT commands and their functions, refer to *Supported AT commands for PPPoE* on page 238.

To track the terminal

The SAILOR FleetBroadband system can be used for tracking purposes. You can set up the terminal to report its position to a server at certain time intervals or after moving a specified distance.

To use the tracking feature you must either set up a tracking server or get a tracking solution from your service provider. The SAILOR FleetBroadband system must be set up to match this server. For information how to set up the SAILOR FleetBroadband system, see *To set up Tracking* on page 138. Once set up on both sides, the SAILOR FleetBroadband system will send position reports to the server as specified.

To use the IP Handset

You can use the IP Handset as a user interface for the SAILOR FleetBroadband System as well as for making calls.

The IP Handset has a dedicated menu for the SAILOR FleetBroadband System. You find a list of the menu items available in *The IP Handset* on page 38.

For information on how to start up the IP Handset, see *To connect the IP handset* on page 25.

For information on how to set up the terminal for IP handsets, see *To manage IP handsets* on page 127.

For further information on how to use the IP Handset, refer to the IP Handset User Manual.

To use the web interface

This chapter describes how to use the web interface to operate, set up and configure your SAILOR FleetBroadband System. It has the following sections:

- *Introduction*
- *To enter the SIM PIN in the web interface*
- *To use the Dashboard*
- *To use the phone book*
- *To use the Call log*
- *To handle SMS messages*
- *To set up the interfaces*
- *To manage LAN network users*
- *To upload software*
- *To select the preferred BGAN satellite*
- *To select the language*
- *Administration*
- *Help desk and diagnostic report*
- *Event logging and self test*
- *Site map*

Introduction

The web interface

What is the web interface?

The web interface is built into the terminal and is used to operate, set up and configure the system. You can access the web interface from a computer with a standard Internet browser.

Proxy settings when you access the web interface

If you are connecting your computer using a LAN or WLAN interface, the **Proxy server** settings in your browser must be disabled before accessing the web interface. Most browsers support disabling of the Proxy server settings for one specific IP address, so you can disable Proxy server settings for the web interface only, if you wish. Consult your browser help for information.

To disable the use of a Proxy server completely, do as follows:

Note

The following description is for **Microsoft Internet Explorer**. If you are using a different browser, the procedure may be different.

1. In Microsoft Internet Explorer, select **Tools > Internet Options > Connections > LAN Settings**.

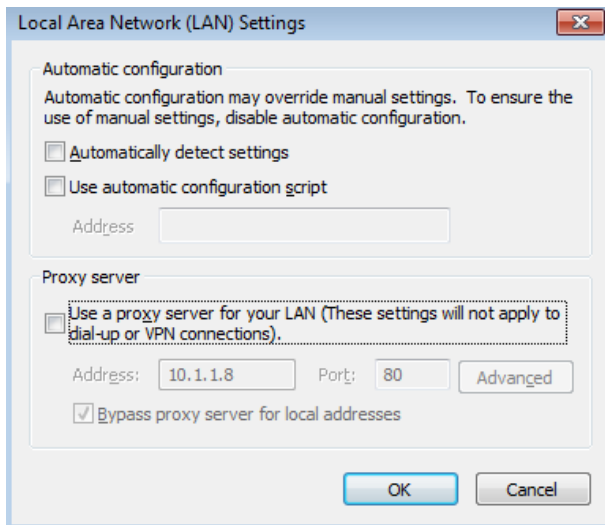

2. Clear the box labeled **Use a proxy server for your LAN**.
3. Click **OK**.

When the proxy server settings are disabled, close and restart your browser. You may need to change this setting back on return to your Internet connection.

To access and navigate the web interface

To access the web interface

To access the web interface, do as follows:

1. Connect your computer to the terminal.
2. Start up the terminal.
For details, see *To get started* on page 19.
3. Open your browser and enter the IP address of the terminal in the address bar. The default IP address of the terminal is **http://192.168.0.1**.

If your connected computer is set up to obtain a DNS server address automatically, you should also be able to use **http://ut.bgan** which is then translated into the local IP address of the terminal.

Note

If the IP address has been changed and you do not have the new address, you can temporarily set the IP address to the default value by pressing the **Reset** button next to the SIM slot in the connector panel of the terminal. You can then access the web interface and change the IP address.

Note that if you do not change the IP address, the default IP address will only be valid until the terminal is powered off. Then the terminal returns to the IP address from before the Reset button was pressed.

For further information on the Reset button, see *Reset button* on page 235.

To change the language

When you have access to the web interface, if you want to display a different language than English, select **SETTINGS > LANGUAGE** from the left menu, select a language from the list and click **Apply**. For further information, see *To select the language* on page 163.

Overview of the web interface

When the web interface opens, the title bar of your browser shows the name of the product.

Note | If no antenna is connected, the title bar will just show SAILOR.

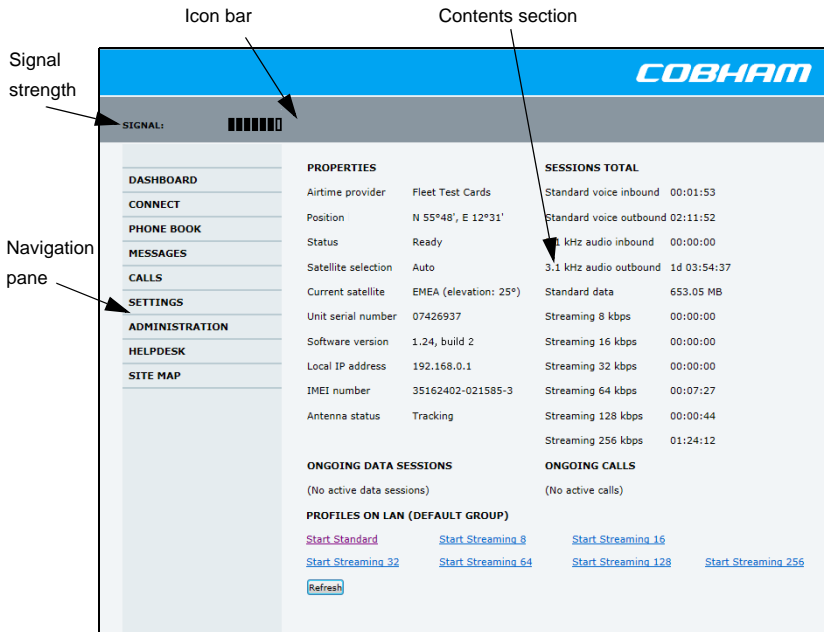

The web interface consists of the following sections.



- The **navigation pane** holds the main menu. Click an item in the menu to open a submenu in the navigation pane or a new page in the contents section.
- The **signal strength** of the satellite signal is shown graphically.
- The **icon bar** shows icons for new SMS messages and for active events, when relevant. For explanations of the icons, see the next section, *Icons in the icon bar*.
- The **contents section** shows the page selected in the navigation pane. In this section you can view or change settings or perform actions.

Icons in the icon bar

The following icons may appear in the icon bar in the web interface:

Icon	Explanation
	<p>A new SMS message, or information of Voice mail, has arrived.</p> <p>Click the icon to see new messages or information of Voice mail. For further information, see <i>To receive a message</i> on page 99.</p>
	<p>An event is active.</p> <p>Click the icon to see a list of active events. For explanations of the event messages, see <i>List of events</i> on page 218.</p> <p>Note that this icon will remain in the icon bar as long as the event is still active.</p>

To navigate the web interface

- **To expand a menu**, click the menu in the navigation pane.
- **To access status and settings**, click the relevant subject in the navigation pane or click the relevant icon in the icon bar. The status or settings are displayed in the contents section.
- **To see the site map**, click **SITE MAP** in the navigation pane. The site map lists all topics and submenus. Click on items in the site map to go directly to the relevant location.

To enter the SIM PIN in the web interface

Do you need a SIM PIN?

Note | You may not have to enter a SIM PIN to access the terminal. This depends on whether or not the use of a SIM PIN is enabled on your SIM card.

If a computer is connected when you start up the terminal, you can access the web interface and enter the SIM PIN here.

To enter the SIM PIN

Note | Using an Administrator user name and password you can change the PIN and enable or disable the use of a PIN. For further information, see *To set up the use of a SIM PIN in the terminal* on page 180.

If your SIM card requires a PIN, and the PIN has not yet been entered, you must enter it. When you access the web interface, it opens on the PIN page. Until you have entered the PIN you can only upload software and view the DASHBOARD. Access to all other parts of the web interface requires a PIN.

For information on how to enter the SIM PIN, see *To enter the SIM PIN using the web interface* on page 29.

When the correct PIN has been entered, the web interface opens the Dashboard and is ready for use.

Note | Some parts of the web interface may be greyed out if the current user does not have permission to access these functions. For information on how to set up user permissions, see *To set up user permissions* on page 182.

To use the Dashboard

Overview

The Dashboard is used for control and inspection of ongoing communication and to view properties and status of the terminal and antenna.

For information on how to start or stop your data sessions from the Dashboard, see *To connect to the Internet* on page 66.

The screenshot displays the COBHAM web interface dashboard. At the top right is the COBHAM logo. Below it, a 'SIGNAL:' indicator shows a full bar of signal strength. On the left is a vertical navigation menu with options: DASHBOARD, CONNECT, PHONE BOOK, MESSAGES, CALLS, SETTINGS, ADMINISTRATION, HELPDESK, and SITE MAP. The main content area is divided into several sections:

- PROPERTIES:**
 - Airtime provider: Fleet Test Cards
 - Position: N 55°48', E 12°31'
 - Status: Ready
 - Satellite selection: Auto
 - Current satellite: EMEA (elevation: 25°)
 - Unit serial number: 07426937
 - Software version: 1.24, build 2
 - Local IP address: 192.168.0.1
 - IMEI number: 35162402-021585-3
 - Antenna status: Tracking
- SESSIONS TOTAL:**
 - Standard voice inbound: 00:01:53
 - Standard voice outbound: 02:11:52
 - 3.1 kHz audio inbound: 00:00:00
 - 3.1 kHz audio outbound: 1d 03:54:37
 - Standard data: 653.05 MB
 - Streaming 8 kbps: 00:00:00
 - Streaming 16 kbps: 00:00:00
 - Streaming 32 kbps: 00:00:00
 - Streaming 64 kbps: 00:07:27
 - Streaming 128 kbps: 00:00:44
 - Streaming 256 kbps: 01:24:12
- ONGOING DATA SESSIONS:** (No active data sessions)
- ONGOING CALLS:** (No active calls)
- PROFILES ON LAN (DEFAULT GROUP):**
 - [Start Standard](#)
 - [Start Streaming 8](#)
 - [Start Streaming 16](#)
 - [Start Streaming 32](#)
 - [Start Streaming 64](#)
 - [Start Streaming 128](#)
 - [Start Streaming 256](#)
 - [Refresh](#)

Properties

The **PROPERTIES** section of the **DASHBOARD** shows the following information:

- **Airtime provider.** The name of your Airtime Provider.
- **Position.** The position of your SAILOR FleetBroadband System.

Note

In some cases, the BGAN network does not allow the position to be displayed to the user. If this is the case, the display may just show **Position acquired**. This means that the position is received, but not shown.

This also applies if the SAILOR FleetBroadband is not yet registered on the BGAN network, but the GNSS position is received.

- **Status.** The status of the SAILOR FleetBroadband System.
The status can be one of the following:
 - **Scanning.** The terminal has instructed the antenna to scan for a BGAN signal. (The antenna status will show “Sky scan”)
 - **Searching.** The antenna has found a BGAN signal and the terminal is searching for a BGAN network in order to perform a registration. (The antenna status will show “Tracking”)
 - **Registering.** The terminal is trying to register with the Satellite Access Station (SAS).
 - **Ready.** The terminal has registered and connected to the SAS and is ready to accept a service request (a call or a data session).
 - **Data active.** The terminal has established a call or a data session through the BGAN network.
 - **No position fix.** The GNSS receiver has not yet achieved position fix. It may take some time to achieve position fix depending on a number of conditions. First of all, the antenna should have an unblocked view to as much of the sky as possible. The terminal will not be able to register with the SAS without a position fix.
 - **Not registered.** The terminal has not been able to register with the BGAN network.

- **Satellite selection.** The satellite selected for logon. For further information, see *To select the preferred BGAN satellite* on page 162.
- **Current satellite.** The satellite to which the system is currently logged on.
- **Unit serial number.** The serial number of the terminal.
- **Software version.** The version of the software embedded in the terminal.
- **Local IP address.** The local IP address of the terminal. This is the IP address used to access the terminal from a device connected to the terminal.
- **IMEI number.** The IMEI number (International Mobile Equipment Identity) of the terminal. This is a unique number that identifies your terminal.
- **Antenna status.** The status of the antenna.
The antenna status can be:
 - **Sky scan.** The antenna is searching for the BGAN signal.
 - **Tracking.** The antenna has found and locked to the BGAN signal. The antenna is now tracking the BGAN signal.
 - **No antenna.** No known antenna is detected by the terminal.

To view information on calls and data sessions

The following sections in the **Dashboard** show information on calls and data sessions.

Note

The counters for calls and data sessions are only intended as a guide and cannot be used for direct comparison with your airtime bill.

- **ONGOING CALLS** is a list of calls that are currently active. The list shows the call type and the time connected for each call.
- **ONGOING DATA SESSIONS** is a list of data profiles that are currently active, including the external IP address that is assigned to each profile.
- **SESSIONS TOTAL** lists the totals for each connection. The list shows the time connected (hh:mm:ss) for voice and Streaming IP, and MB transferred for Standard data.

The counters show totals for connections since the counters were last cleared. For information on how to clear the counters, see *Log handling* on page 169.

PROPERTIES		SESSIONS TOTAL	
Airtime provider	Fleet Test Cards	Standard voice inbound	00:01:53
Position	N 55°48', E 12°31'	Standard voice outbound	02:11:52
Status	Ready	3.1 kHz audio inbound	00:00:00
Satellite selection	Auto	3.1 kHz audio outbound	1d 03:54:37
Current satellite	EMEA (elevation: 25°)	Standard data	653.05 MB
Unit serial number	07426937	Streaming 8 kbps	00:00:00
Software version	1.24, build 2	Streaming 16 kbps	00:00:00
Local IP address	192.168.0.1	Streaming 32 kbps	00:00:00
IMEI number	35162402-021585-3	Streaming 64 kbps	00:07:27
Antenna status	Tracking	Streaming 128 kbps	00:00:44
		Streaming 256 kbps	01:24:12
ONGOING DATA SESSIONS		ONGOING CALLS	
(No active data sessions)		(No active calls)	
PROFILES ON LAN (DEFAULT GROUP)			
Start Standard		Start Streaming 8	
		Start Streaming 16	

To use the phone book

General usage

Overview

In the phone book you can:

- Look up phone numbers.
- Look up short-dial numbers for easy dialing from a handset.
- Modify or delete existing names and phone numbers, or add new names and phone numbers.

Note

If you are using a SAILOR FleetBroadband IP handset with your terminal, the contacts from this terminal phone book are included (read only) in your handset phone book.

To access the phone book

To access the phone book, select **PHONE BOOK** from the left navigation pane.

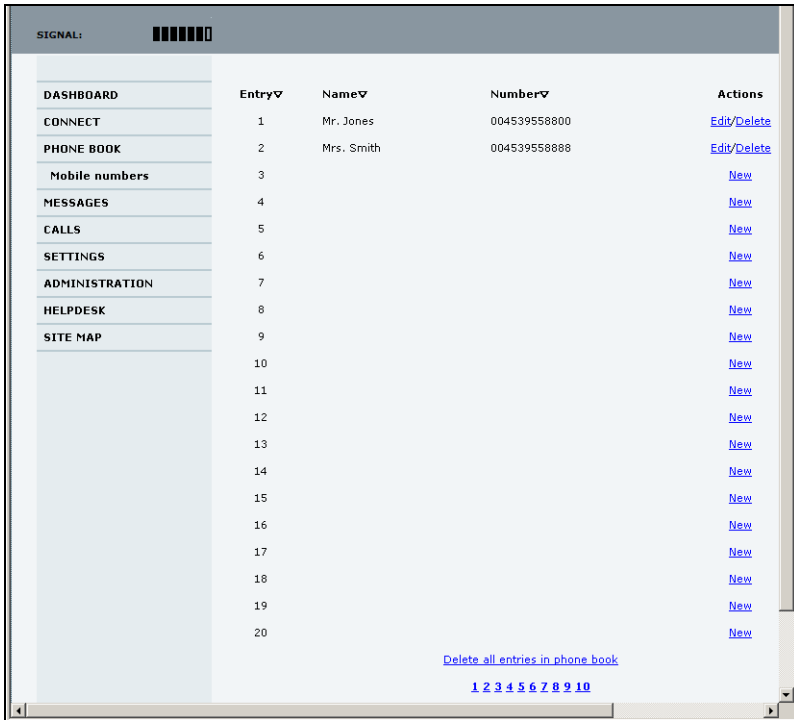

The screenshot shows a web interface with a left navigation pane and a main content area. The navigation pane includes items like DASHBOARD, CONNECT, PHONE BOOK (highlighted), Mobile numbers, MESSAGES, CALLS, SETTINGS, ADMINISTRATION, HELPDESK, and SITE MAP. The main content area displays a table with the following data:

Entry▼	Name▼	Number▼	Actions
1	Mr. Jones	004539558800	Edit/Delete
2	Mrs. Smith	004539558888	Edit/Delete
3			New
4			New
5			New
6			New
7			New
8			New
9			New
10			New
11			New
12			New
13			New
14			New
15			New
16			New
17			New
18			New
19			New
20			New

At the bottom of the table, there is a link: [Delete all entries in phone book](#) and a pagination link: [1](#) [2](#) [3](#) [4](#) [5](#) [6](#) [7](#) [8](#) [9](#) [10](#)

The phone book shows all entries with entry number, name and phone number. Empty place holders are also included.

To sort the phone book, click the title of the column you wish to sort by. For example, to sort by the names in the phone book alphabetically, click on **Name** in the top row of the phone book.

The phone book holds 199 entries divided into subpages. To select the subpages you want, click the relevant link at the bottom of the page.

Short dial

The entry number in the phone book is the Short dial number. When you make a call from the terminal you can use this number instead of the entire phone number.

Dial **00 <short dial>** followed by **#** or off-hook key.

Example: To call the third entry in the phone book from an analog phone, take the phone off hook and dial **003 #**.

To edit phone book entries

To add a new entry

To add a new entry, do as follows:

1. In the phone book, locate the empty entry number where you want to add the new phone number and click **New**.
2. Type in the name and phone number of the new entry and click **Save entry**.

The new name and number are now listed at the specified entry number in the phone book.

To modify an entry in the phone book

To modify an entry, do as follows:

1. In the phone book, click **Edit** next to the entry you want to modify.
2. Modify the name or number as wanted and click **Save entry**.

The name and/or number in the selected entry is now replaced with the new information.

To delete an entry in the phone book

To delete an entry, click **Delete** next to the entry you want to delete.

To delete all entries in the phone book

To delete all the entries in the phone book, click **Delete all entries in phone book** at the bottom of the **PHONE BOOK** page.

To view and edit the mobile numbers

The mobile numbers are the phone numbers to use when you make a call to the terminal.

To view the mobile numbers

To view the mobile numbers of the terminal, select **PHONE BOOK > Mobile numbers** from the left navigation pane.

Note

These numbers are not listed at delivery. The user must enter the numbers received from the Airtime Provider.

MOBILE NUMBERS	
Standard voice	+870772100101
3.1 kHz audio	+870772100102
UDI (64 kbps)	+870772100103
RDI (56 kbps)	+870772100104
Edit	

Additional numbers: If you have additional numbers in your subscription, you can enter them as well. Below is an example of a Mobile numbers list with additional numbers.

MOBILE NUMBERS	
Standard voice	+870772100101
3.1 kHz audio	+870772100102
UDI (64 kbps)	+870772100103
RDI (56 kbps)	+870772100104
ADDITIONAL NUMBERS	
Standard voice #2	+870772100112
Standard voice #3	+870772100113
Standard voice #4	+870772100114
Standard voice #5	
Standard voice #6	
Standard voice #7	
Standard voice #8	
Standard voice #9	
Standard voice #10	
Standard voice #11	
Standard voice #12	
Standard voice #13	
Edit	

To enter or edit the mobile numbers

To enter or edit the mobile numbers, click **Edit** at the bottom of the page, type in the numbers received from your Airtime Provider and click **OK**.

To use the Call log

Note

If power to the system is interrupted, the information on the currently ongoing calls (connection time) and data sessions (transferred data) cannot be saved. This could mean that the airtime and bandwidth usage registered in the Call log will be inaccurate and there is a risk of being charged for more airtime than registered in the web interface.

Information on total usage

To enter the CALLS page select **CALLS** from the left navigation pane. This page contains information on usage for circuit-switched connections.

The listed information includes:

- time connected using Standard Voice and
- time connected using 3.1 kHz Audio.

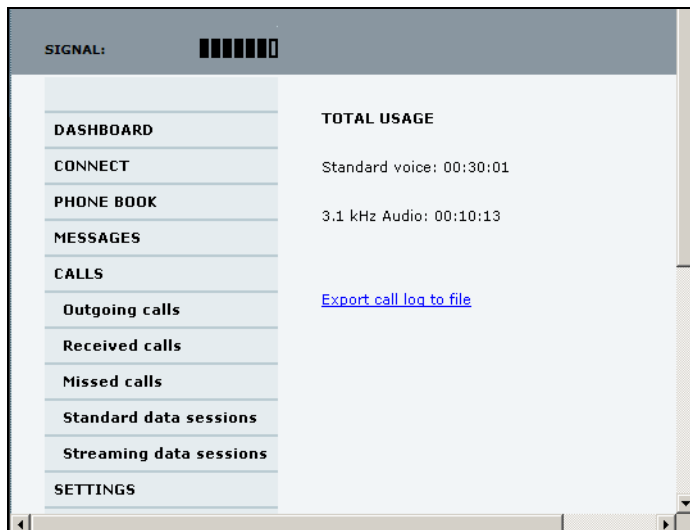

To export the call log

You can export the call log file and save it on your computer for archiving, surveillance or other tracking purposes.

The call log holds information on all calls and data sessions since the call log was last cleared. For information on how to view the lists of calls and data sessions, see the next section.

To export the entire call log to a file, do as follows:

1. In the **CALLS** page, click the link **Export call log to file**.
2. Browse to the location where you want to save the log.
3. Click **OK**.

To view the lists of calls and data sessions

To see information on outgoing, received or missed calls or data sessions, select one of the following lists from the left navigation pane in the **CALLS** page:

- **Outgoing calls** shows the start time, receiving end phone number, duration, type (Standard or 3.1 kHz Audio) and estimated charge of each outgoing call.
- **Received calls** shows the start time, calling phone number, duration and type (Standard or 3.1 kHz Audio) of each incoming call.
- **Missed calls** shows the start time, calling phone number and type (Standard or 3.1 kHz Audio) of each incoming call that was not received.
- **Standard data sessions** shows the start time, bytes in, bytes out and estimated charge of each Standard IP session.
- **Streaming data sessions** shows the start time, duration, type (Streaming 8, 16, 32, 64, 128 or 256 kbps) and estimated charge of each Streaming IP session.

Date and time is the international UTC time, received from the satellite.

For information on the available types of service, see *The BGAN services supported by SAILOR FleetBroadband* on page 14.

Note

The estimated charge is based on your entries under ADMINISTRATION > Call charges. Cobham SATCOM does not take responsibility for the correctness of this estimated charge.

You can sort each of the lists by clicking the title of the column you wish to sort by.

If a list covers more than one page, you can click the relevant link at the bottom of the page, to go to another page.

When there are more than 100 calls in the total list, the oldest calls are automatically removed to make room for new calls.

To handle SMS messages

To send an SMS message

Important

If the terminal is not online when you attempt to send a message, the message is moved to the Outbox instead of the Sent folder. Messages in the Outbox are **not** automatically sent when the terminal goes online. For further information on the Outbox, see the next section, *Options for messages in the Outbox*.

To make sure a message has been sent, check that it has been moved to the Sent folder.

To send an SMS message **from** the terminal, do as follows:

1. Click **MESSAGES** from the left navigation pane. This page contains new incoming messages.
2. In the left navigation pane, click **Write message**.

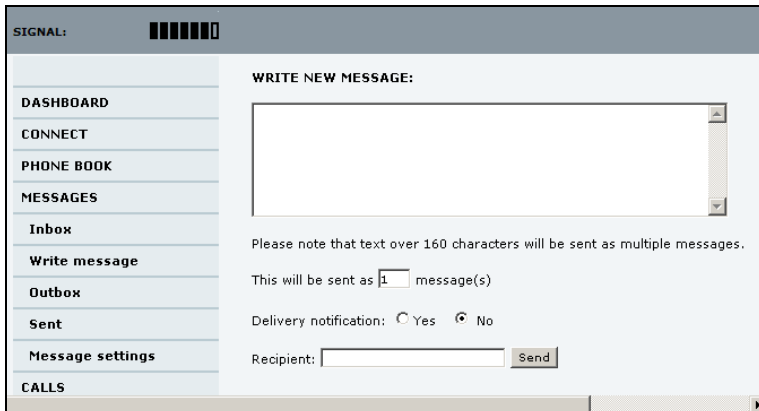

3. Type in the message in the **Write new message** field. If the message text is too long for one SMS, the message is sent as two or more SMS messages. The field below the message field shows the number of SMS messages used to send the message.

4. Type in the phone number in the **Recipient** field.
Remember **00** and **country code** (e.g. **00 45** for Denmark or **00 1** for USA).
5. Select whether or not you want **Delivery notification** for this SMS message.
If you click Yes, the Status column in the Sent folder will show the status of your message when it has been sent.
You can set up delivery notification generally for all SMS messages. This setting is used by default when you send a message. For further information, see *To configure message settings* on page 101.
6. Click **Send**.
The message is now sent and moved to the Sent folder.

Options for messages in the Outbox

Messages in the Outbox are messages that have not been sent, e.g. because the terminal was not online when you attempted to send the messages.

To access the Outbox, click **MESSAGES > Outbox** from the navigation pane.

You have the following options for messages in the Outbox:

- When the terminal is online, click **Resend** next to the message you want to send. When the **Write message** page opens, click **Send**.
The terminal now attempts to send the message again. To make sure the message has been sent, look in the Sent folder.

Note

The original message remains in the Outbox. When you have succeeded in sending the message you may want to delete it from the Outbox.

- Click **Delete** next to a message to delete it.
- Click **Delete all messages in Outbox** to delete all the messages.

Options for messages in the Sent folder

The Sent folder contains SMS messages that have been sent. To access the Sent folder, select **MESSAGES > Sent** from the navigation pane.

The Status column shows the status of each message if you have selected Delivery notification when you send the message.

From the Sent folder you have the following options:

- Click **Resend** next to a message you want to send again.
When the Write message page opens, click **Send**.
The terminal now attempts to send the message again. To make sure the message has been sent, look in the Sent folder. There should now be two copies of the sent message.
- Click **Forward** next to a message you want to forward.
Type in the phone number of the new recipient and click **Send**.
The terminal now attempts to send the message to the new recipient. To make sure the message has been sent, look in the Sent folder.
- Click **Delete** next to a message to delete it.
- Click **Delete all sent messages** to delete all the messages.

To send an SMS message to the terminal

You can send an SMS message to the terminal e.g. from a mobile phone, using one of the mobile numbers for voice. Dial

+ <**Mobile number**>

The first part of the mobile number is always 870, which is the “country code” for the BGAN system. If the mobile numbers are listed in the web interface, you can look them up as follows:

Select **PHONE BOOK > Mobile numbers**. If the mobile numbers are not listed in the web interface, refer to the documents provided with your airtime subscription.

Note

There are two Voice numbers, one for 3.1 kHz Audio and one for Standard Voice.

To receive a message

If a message has arrived, the icon bar at the top of the web interface shows an unopened envelope. Click the envelope to see the new message(s).

Otherwise, to see new messages click **MESSAGES** from the left navigation pane.

The page shows new incoming messages.

Note

The terminal does not accept more than 100 incoming messages (including read and unread messages). If you have received 100 messages, you have to delete some of them in order to free space for new messages. Otherwise, the new messages are rejected.

If the message is not an SMS message but information of voice mail, call your Voice mail service number to hear the Voice mail. The Voice mail service number is normally listed in the SMS message.

You may also find the Voice mail service number under **MESSAGES > Message settings**. Note that the voice mail number is only shown here if it is available on the SIM card. Otherwise, refer to the information included with your Airtime subscription.

Options for new SMS messages

To see new messages, click **MESSAGES** from the left navigation pane.

Besides viewing the new messages, you have a number of options for what to do with each message:

- Click **Archive** to move it to your Inbox containing read messages.
- Click **Reply** to reply to a message.
Then type in your reply and click **Send**.
For information on how to include the original message in your reply, see *To set up the default message options* on page 101.
- Click **Forward** to forward a message to someone.
Then type in the phone number in the **Recipient** field and click **Send**.
- If you want to move all the new messages, click **Move all new messages to Inbox**.

Note

New messages cannot be deleted until they have been moved to the Inbox.

Options for SMS messages in the Inbox

The messages in the Inbox are the incoming messages that have been read and moved from the list of new messages (refer to the previous section).

From the Inbox, you have the following options:

- Click **Reply** to reply to a message.
Then type in your reply and click **Send**.
For information on how to include the original message in your reply, see *To set up the default message options* on page 101.
- Click **Forward** to forward a message to someone.
Then type in the phone number in the **Recipient** field and click **Send**.
- Click **Delete** to delete the message.
- Click **Delete all messages in Inbox** to delete all read messages in the Inbox.

To configure message settings

To set up the default message options

You can set up general options for your outgoing messages. These settings apply by default to all your outgoing messages. Note, however, that you can change the Delivery notification setting for an individual message. For further information, see *To send an SMS message* on page 96.

Do as follows:

1. Select **MESSAGES > Message settings** from the left navigation pane.



The screenshot shows a settings dialog box with the following fields and options:

- SMS service center: +870772001799 [Edit](#)
- Voice mail number: +870772001899
- Include message in reply: Yes No
- Delivery notification: Yes No

At the bottom of the dialog are two buttons: **Apply** and **Cancel**.

2. If you want to include the original message when you reply, select **Yes** next to **Include message in reply**.
3. Select whether or not you want **Delivery notification** for SMS messages.
If you click Yes, the Status column in the Sent folder will show the status of your message when it has been sent.
4. Click **Apply**.

To view or change SMS service centre number

The SMS service centre number identifies the SMS service centre used when you send and receive SMS messages. The SMS service centre number is stored on the SIM card.

- To see the SMS service centre number, select **MESSAGES > Message settings** from the left navigation pane.
- To change the number, click **Edit** next to **SMS service centre**, change the number and click **Save**. Then click **Apply** to apply all changes in the page.

The SMS service centre number is provided from your Airtime Provider.

To view the Voice mail number

You get an SMS notification in the web interface when you have received Voice mail. The Voice mail number is the number you call to hear your incoming voice mail.

Note

The Voice mail number is only listed here if it is available on the SIM card. Otherwise, see the information included in the SMS notification or refer to the documents included with your Airtime subscription.

To see the Voice mail number, select **MESSAGES > Message settings** from the left navigation pane. The **Voice mail number** field shows the Voice mail number.

To set up the interfaces

The **SETTINGS** page (Antenna properties)

The **SETTINGS** page shows properties of the connected antenna and contains a field for enabling or disabling the L-Band interface on the terminal.

To access the **SETTINGS** page, select **SETTINGS** from the left navigation pane.

DASHBOARD	ANTENNA
CONNECT	Antenna bootloader version: 1.5
PHONE BOOK	Antenna software version: 1.53
MESSAGES	Antenna serial number: 15704719
CALLS	L-BAND CONNECTOR
SETTINGS	L-band connector <input type="radio"/> Enable <input checked="" type="radio"/> Disable
LAN	<input type="button" value="Apply"/> <input type="button" value="Cancel"/>
Phone/Fax	
ISDN	

Note

If the HPA module in the antenna has been replaced the **Antenna serial number** field shows "0". You can still see the serial number on the label underneath the antenna.

Enabling or disabling the L-Band interface

The L-Band interface is used for connecting a broadband receiver for reception of position data. To enable or disable the L-Band interface, do as follows:

1. In the **L-BAND CONNECTOR** field of the **SETTINGS** page, select **Enable** or **Disable**.
2. Click **Apply**.

Note

The L-Band output is disconnected if the built-in antenna RF-noise filter is active, i.e. if the filter is set to Auto and the SAILOR FleetBroadband is subjected to interference inside the Inmarsat L-Band, or if the filter is set to On. See *Antenna RF noise filter* on page 195.

To configure the LAN interface

Overview

The SAILOR FleetBroadband Terminal has 4 LAN connectors with PoE (Power over Ethernet).

The major part of the LAN parameters are set up in the network management pages, which require administrator password. For information on these settings, refer to *To manage LAN network users* on page 142.

IP addressing

In the web interface you can set up the Internet connection mode and the IP addressing between the terminal and devices connected to the terminal. The terminal has a built-in DHCP server which can be used to dynamically assign IP addresses to devices connected to the terminal.

The drawing below shows examples of the IP addressing in Router mode (default setup) and Bridge mode.

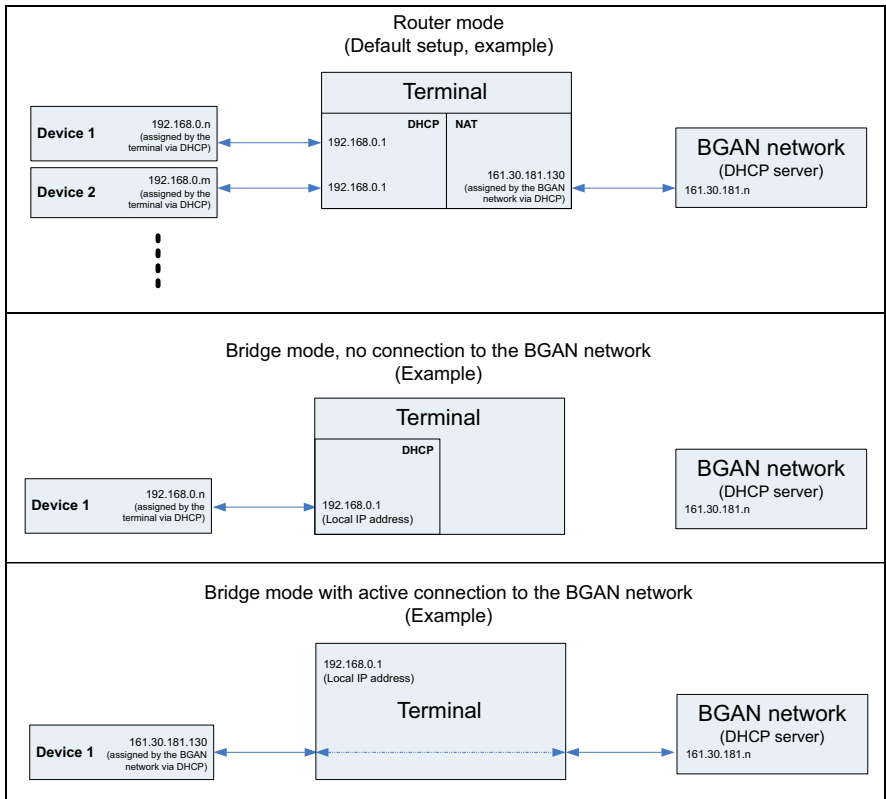

The following section describes how to set up local IP address and DHCP. For information on Router/Bridge mode, see step 5 on page 147 in the section *To edit a network user group*.

To set up the local LAN IP addresses



Caution! All connections to the LAN interface may be affected when you change the LAN settings. This also includes your own current connection.

To change the local IP addresses, do as follows:

1. From the left navigation pane, select **SETTINGS > LAN**.

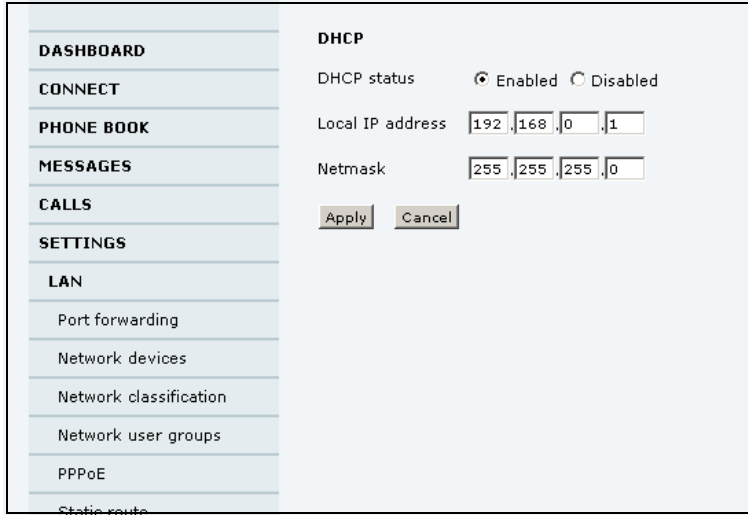

2. At **DHCP status**, select **Enabled** (recommended for most purposes), or **Disabled**.
 - If you select **Enabled**, the terminal assigns dynamic IP addresses to devices connected to the terminal.
 - If you select **Disabled**, you need to set up a static IP address in the connected device.

Note

A number of IP subnets cannot be used in connected devices because they are reserved for internal use in the terminal. See *List of reserved IP subnets* on page 237.

3. If you want to change the **Local IP address** and the **Netmask** of the terminal, type in the new address and netmask.

The Local IP address is the IP address of the terminal. It is used to access the web interface. By default, the address is 192.168.0.1 and the netmask is 255.255.255.0.
4. Click **Apply**.

Port forwarding

Port forwarding enables you to set up a server connected to the terminal while the terminal is in Router mode. Without port forwarding it would not be possible to contact the server from the Internet.

We recommend using a static public IP address for the terminal in order to provide easy access to the terminal. For information on how to set up a static IP address, refer to step 6 on page 147 in the section *To edit a network user group*.

For information on how to set the terminal in Router mode, see step 5 on page 147 in the section *To edit a network user group*.

The following example shows how to allow Internet access to a mail server (smtp) connected to the terminal.

The mail server in this example has the IP address 192.168.0.100.

1. Select **LAN > Port forwarding** in the left navigation pane.

PORT FORWARDING

Port forwarding Enabled Disabled

Active	Incoming port range	Destination IP	Destination port range
<input checked="" type="checkbox"/>	25 - 25	192.168.0.100	25 - 25
<input type="checkbox"/>	0 - 0	0.0.0.0	0 - 0
<input type="checkbox"/>	0 - 0	0.0.0.0	0 - 0
<input type="checkbox"/>	0 - 0	0.0.0.0	0 - 0
<input type="checkbox"/>	0 - 0	0.0.0.0	0 - 0
<input type="checkbox"/>	0 - 0	0.0.0.0	0 - 0
<input type="checkbox"/>	0 - 0	0.0.0.0	0 - 0
<input type="checkbox"/>	0 - 0	0.0.0.0	0 - 0
<input type="checkbox"/>	0 - 0	0.0.0.0	0 - 0
<input type="checkbox"/>	0 - 0	0.0.0.0	0 - 0

2. Select **Enabled** to generally enable port forwarding.

3. Type in the **Incoming port range**.
4. Type in the **Destination IP** address, which in this example is the IP address of the mail server: 192.168.0.100.
5. Type in the **Destination port range**.
6. Repeat step 3 to step 5 to set up port forwarding to additional servers.
7. In the **Active** column, select which ports should have port forwarding activated.
8. Click **Apply**.

You can now access the mail server from the Internet, using the public IP address of the terminal. If you do not know the IP address, you can look it up in the **DASHBOARD** of the web interface under **ONGOING DATA SESSIONS**.

To enable PPPoE (Point-to-Point Protocol over Ethernet)

What is PPPoE

By using PPPoE, users can virtually “dial” from one machine to another over an Ethernet network, establish a point to point connection between them and then securely transport data packets over the connection.

On the equipment connected to the SAILOR FleetBroadband Terminal you must enter a few settings for your PPPoE connection. For example you need to set up which service to use and possibly a user name and password. For details, refer to *To use PPPoE (Point-to-Point Protocol over Ethernet)* on page 72 and to the documentation for your connected equipment.

On the SAILOR FleetBroadband Terminal you must enable PPPoE before you can establish a PPPoE connection. Refer to the next section.

To enable PPPoE in the SAILOR FleetBroadband Terminal

To enable PPPoE in the terminal do as follows:

1. Select **SETTINGS > LAN > PPPoE**.

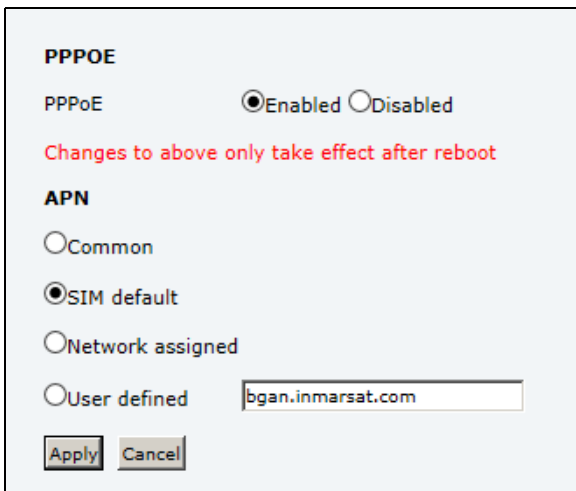

PPPOE

PPPoE Enabled Disabled

Changes to above only take effect after reboot

APN

Common

SIM default

Network assigned

User defined

2. Select **Enabled**.

3. Select the **APN** to use for PPPoE. You have the following options:
 - **SIM default.** The APN is taken from the SIM card. This is the recommended option, unless you have special requirements.
 - **Network assigned.** The APN is assigned from the network.
 - **User defined.** Type in the APN. APNs are provided from the Airtime Provider.
4. Click **Apply**.
5. Restart the terminal for the setting to take effect.

For information on how to establish a connection with PPPoE, see *To use PPPoE (Point-to-Point Protocol over Ethernet)* on page 72.

To set up static routing

When you have an external gateway connected to your terminal, the terminal is not automatically able to “see” the network on the other side of the gateway. However, you can set up your terminal to communicate with a device on the other side of a gateway, by using Static routing.

To set up a new device for static routing, do as follows:

1. Select **SETTINGS > LAN > Static route.**

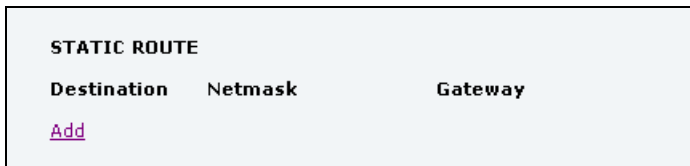

STATIC ROUTE		
Destination	Netmask	Gateway
Add		

2. Click **Add**.

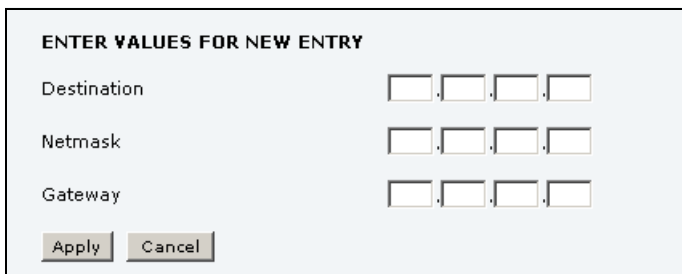

ENTER VALUES FOR NEW ENTRY							
Destination	<input type="text"/>	.	<input type="text"/>	.	<input type="text"/>	.	<input type="text"/>
Netmask	<input type="text"/>	.	<input type="text"/>	.	<input type="text"/>	.	<input type="text"/>
Gateway	<input type="text"/>	.	<input type="text"/>	.	<input type="text"/>	.	<input type="text"/>
<input type="button" value="Apply"/>		<input type="button" value="Cancel"/>					

3. Enter the values for your device.
 - Destination: The IP address you want to route to.
 - Netmask: The netmask you want to route to.
 - Gateway: The gateway, e.g. the address of a wireless access point or router to which the destination device is connected.
4. Click **Apply**.

The values for the new entry are now in the list. This means that the terminal can communicate with the destination IP address on the other side of the gateway.

STATIC ROUTE			
Destination	Netmask	Gateway	
192.150.1.4	255.255.255.0	192.150.1.0	Edit/Delete
Add			

To configure the Phone/Fax interface

To configure the Phone/Fax interface do as follows:

1. Select **SETTINGS > Phone/Fax** from the left navigation pane.

The screenshot shows a configuration window for Phone/Fax ports. It is divided into two sections: PORT 1 and PORT 2. Each section has an 'Assigned number' dropdown menu, 'Incoming calls' and 'Outgoing calls' radio button options, and a 'Restricted dialing' toggle. At the bottom of the window are 'Apply' and 'Cancel' buttons.

Port	Assigned number	Incoming calls	Outgoing calls	Restricted dialing
PORT 1	+870772100112	<input checked="" type="checkbox"/> Standard <input checked="" type="checkbox"/> 3.1 kHz Audio	<input checked="" type="radio"/> Standard <input type="radio"/> 3.1 kHz Audio	Enabled
PORT 2		<input checked="" type="checkbox"/> Standard <input checked="" type="checkbox"/> 3.1 kHz Audio	<input checked="" type="radio"/> Standard <input type="radio"/> 3.1 kHz Audio	Enabled

2. If you have additional numbers from your airtime provider and you want to assign them to the Phone/Fax ports, use the **Assigned number** drop down list to select the number you want to use for each port.

When this number is called, only the handset connected to that port will ring.

Note

To be able to use the additional numbers, you must first select **Use additional numbers** in the **Multi-voice** page and enter the additional numbers under **PHONE BOOK > Mobile numbers**. See *Multi-voice* on page 191.

3. For each Phone/Fax port, set the call type for incoming and outgoing calls.

Note

Port 1 is the connector closest to the antenna connector, and Port 2 is the connector closest to the ISDN connector.

The call types are described in more detail in *To select the call type* on page 43.

- For **Incoming calls**, you can select Standard or 3.1 kHz Audio or both.
If you select both, any device connected to the Phone/Fax interface will react (ring) on incoming calls.
If you select e.g. Standard, the Phone/Fax interface will only react on calls made to the Standard phone number.
- For **Outgoing calls**, you can select either Standard or 3.1 kHz Audio. The selected type will be used by default, if possible, for any outgoing call. Note, however, that fax machines must use 3.1 kHz Audio.

Note

You can override the default setting for outgoing calls by dialling 1* (force the call to Standard) or 2* (force the call to 3.1 kHz Audio) before the number. For further information, see *To override the default outgoing call type* on page 44.

4. For each port you can see whether or not Restricted dialing is enabled. For further information, see *Restricted dialing* on page 189.
5. Click **Apply**.

To configure the ISDN interface

Note For information on how to set up call services (supplementary services), see *To set up call services* on page 119. These settings apply to both the Phone/Fax interface, the ISDN interface and the LAN w. PoE interface.

To configure the ISDN interface, do as follows:

1. Select **SETTINGS > ISDN**.

PORT 1

Assigned number: +870772100113

Incoming calls: Standard 3.1 kHz Audio UDI RDI

MSN numbers: <None> <None> <None> <None>

Outgoing calls: Automatic Standard 3.1 kHz Audio

Audio echo canceller: Enabled Disabled

Restricted dialing: Enabled

Buttons: Apply, Cancel

2. If you have additional numbers from your airtime provider and you want to assign them to the ISDN ports, use the **Assigned number** drop down list to select the number you want to use for each port. When this number is called, only handsets connected to that port will ring.

Note To be able to use the additional numbers, you must first select **Use additional numbers** in the **Multi-voice** page and enter the additional numbers under **PHONE BOOK > Mobile numbers**. See *Multi-voice* on page 191.

If you have assigned a number, skip the next two steps and go to step 5.

3. Set the call type(s) for incoming calls.

You can select Standard, 3.1 kHz Audio, UDI and/or RDI. Note that SAILOR 250 FleetBroadband only supports Standard or 3.1 kHz Audio.

Note

Connected devices will only receive incoming calls with the call types that are selected here.

For example, if only Standard is selected, and a G4 fax call (using call type UDI) arrives, a fax connected to the ISDN port will not receive the incoming call.

4. Set the MSN (Multiple Subscriber Number) numbers that are to be assigned to each call type.

Note that this setting only applies to the call type selected above the MSN number, and only if the connected device supports the call type used.

If you have assigned a number to the ISDN port, the MSN setting is not available.

Important

If you set an MSN number to anything other than <None>, connected devices must be programmed with these MSN numbers.

You have the following options with the MSN numbers:

- **<None>**: No MSN numbers are used. An incoming call is accepted in all devices connected to this port.
- **1*, 2*, 3* or 4***: If, for example, you select 1* at Standard call type, an incoming Standard call is accepted by all devices that are programmed with the number 1* and connected to the ISDN interface.
- **0401, 0402**: These are local numbers for separate devices connected to the ISDN interface.
An incoming call is accepted by devices that are programmed with the selected number and connected to the ISDN interface.

You can combine the MSN settings.

Example: You have two devices connected to the ISDN interface. One is programmed with the numbers 1* and 0401, the other is programmed with 1* and 0402.

In the web interface, you select the MSN number 1* under

Standard.

If an incoming Standard call arrives, both devices will accept the call.

If you make a local call to one of the local numbers 0401 or 0402, only the called device will accept the call.

5. Set the call type for outgoing calls.
 - If you select **Automatic**, the call type will be determined by the calling device.
 - If you select **Standard**, all outgoing calls, except UDI/RDI, will use the call type Standard. If you make a 3.1 kHz Audio call it will be converted to a Standard call. Outgoing UDI or RDI sessions will not be influenced by this setting.
 - If you select **3.1 kHz Audio**, all outgoing calls, except UDI/RDI, will use the call type 3.1 kHz Audio. If you make a Standard call it will be converted to a 3.1 kHz Audio call. Outgoing UDI or RDI sessions will not be influenced by this setting.

Note

You can override the call type setting for outgoing calls by dialling one of the following prefixes before the number:

- 1* (force the call to Standard)
- 2* (force the call to 3.1 kHz Audio)

Refer to *To override the default outgoing call type* on page 44.

6. If you hear an echo in your ISDN handset and the handset does not have its own echo canceller, enable the **Audio echo canceller**.

Note

If you are using the ISDN port for ISDN data, make sure the Audio echo canceller is **disabled** to avoid loss of data.

7. At the bottom you can see whether or not Restricted dialing is enabled. For further information, see *Restricted dialing* on page 189.
8. Click **Apply**.

Common interface settings

Overview

The settings under COMMON are common for all interfaces.

Note

In order to use the common Access Point Name for an interface, you must select **Common** for the APN setting when you set up the network user group.

Definition of Access Point Name (APN)

The APN is used by the network user to establish a connection to the required external network. This means that the terminal must know the APN in order to be able to connect to the external network.

APNs are provided from the Airtime Provider. They may also be defined on the SIM card.

How to use the common APN

When you configure the APN for your individual network user group, select **Common** to use the setting from this page.

If you are using the same APN for many network user groups, it is easier to define it once under Common, and then simply select Common for the relevant network user groups. Also, if you change the common APN at a later stage, it is automatically updated for all network user groups where the Common setting is selected.

To change the common interface settings

To change the common interface settings, do as follows:

1. Select **SETTINGS > Common**.

The screenshot shows a web interface for configuring common interface settings. On the left is a vertical menu with the following items: DASHBOARD, CONNECT, PHONE BOOK, MESSAGES, CALLS, SETTINGS, LAN, Phone/Fax, ISDN, Common (highlighted), Call forward, Call barring, Call waiting, Line identification, and Closed user group. The main content area is titled 'COMMON INTERFACE SETTINGS' and is divided into two sections. The first section is 'APN', which has three radio button options: 'SIM default' (which is selected), 'Network assigned', and 'User defined'. The 'User defined' option has a text input field next to it. The second section is 'PROFILES', which has a label 'Buffering on streaming profiles' followed by two radio button options: 'Enabled' (selected) and 'Disabled'. At the bottom of the main content area are two buttons: 'Apply' and 'Cancel'.

2. Select the **APN**. You have the following options:
 - **SIM default**. The APN is taken from the SIM card. This is the recommended option, unless you have special requirements.
 - **Network assigned**. The APN is assigned from the network.
 - **User defined**. Type in the APN. APNs are provided from the Airtime Provider.
3. At **Buffering on Streaming profiles**, select **Enabled** or **Disabled**.
 - If you select **Enabled**, your Streaming connection will be buffered. This means that the transmission is slightly delayed in order to ensure a precise and continuous data stream.
 - If you select **Disabled**, your Streaming connection will not be buffered. This means the data is delivered immediately, but may vary slightly in transmission speed.
4. Click **Apply**.

To set up call services

Overview

The setup of call services is also common for all interfaces.

Note

The terminal must be registered on the BGAN network before you can set up the call services in the web interface.

In the web interface you can set up the following supplementary services:

- Call forwarding
- Call barring
- Call waiting
- Line identification
- Closed user group

Note that, depending on the network, some of these call service settings may prevent others from being activated.

The settings apply for all connected devices using a circuit-switched service.

Call forwarding

You can set up the terminal to automatically forward incoming calls to another phone number. This information is saved in the BGAN network so it is available when the call cannot be put through and must be forwarded. This service is usually set up by the airtime provider.

To set up call forwarding, do as follows:

1. Select **SETTINGS > Common > Call forward** from the left navigation pane.

Read current settings

STANDARD VOICE

Forward all calls Enabled

Forward when busy Enabled

Forward if not reachable Enabled

Forward if no reply Enabled when unanswered in

3.1 KHZ AUDIO

Forward all calls Enabled

Forward when busy Enabled

Forward if not reachable Enabled

Forward if no reply Enabled when unanswered in

DATA/ISDN

Forward all calls Enabled

Forward when busy Enabled

Forward if not reachable Enabled

Forward if no reply Enabled when unanswered in

Please note that some active call forward, call barring or call waiting settings may prevent other call forward, call barring or call waiting settings from being activated

2. Click **OK** next to **Read current settings** to display the phone numbers for call forwarding for the subscription. These numbers are operator controlled and come with your airtime subscription (default). A message, **Operation in progress, please wait**, is displayed.
3. For each call type, select **Enabled** next to the situation(s) in which you want to forward incoming calls.

Note **Forward when busy** is not available if Multi-voice is enabled. This setting must be enabled before enabling Multi-voice.

4. Next to the enabled items, type in the phone number you want to forward the call to.
5. If you have selected **Forward if no reply**, select from the drop-down list the period of time the system should wait before forwarding the call.
6. Click **Apply**.

Call barring

Do as follows to bar incoming and/or outgoing calls to and from the terminal:

1. Select **SETTINGS > Common > Call barring** from the left navigation pane.

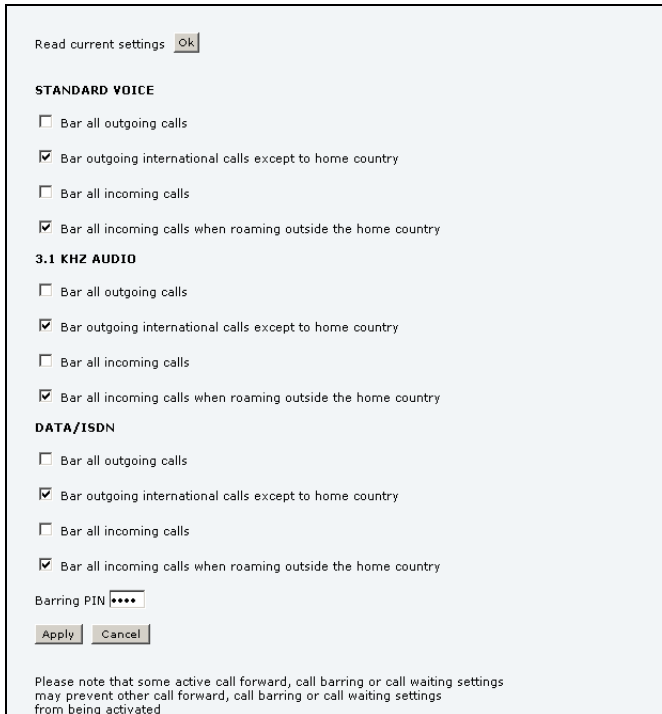

Read current settings

STANDARD VOICE

Bar all outgoing calls

Bar outgoing international calls except to home country

Bar all incoming calls

Bar all incoming calls when roaming outside the home country

3.1 KHZ AUDIO

Bar all outgoing calls

Bar outgoing international calls except to home country

Bar all incoming calls

Bar all incoming calls when roaming outside the home country

DATA/ISDN

Bar all outgoing calls

Bar outgoing international calls except to home country

Bar all incoming calls

Bar all incoming calls when roaming outside the home country

Barring PIN

Please note that some active call forward, call barring or call waiting settings may prevent other call forward, call barring or call waiting settings from being activated

2. Click **OK** next to **Read current settings**, to make sure the page is updated.
3. For each call type, select which calls should be barred.
4. In the **Barring PIN** field, type in the PIN for your call barring setup.

Note

This is **not** the SIM PIN entered at startup, but a network PIN which is supplied together with your SIM PIN.

5. Click **Apply**.

Call waiting

You can set up whether or not you want to receive notification of waiting calls while you are making a call or transmitting data.

Do as follows:

1. Select **SETTINGS > Common > Call waiting** from the left navigation pane.

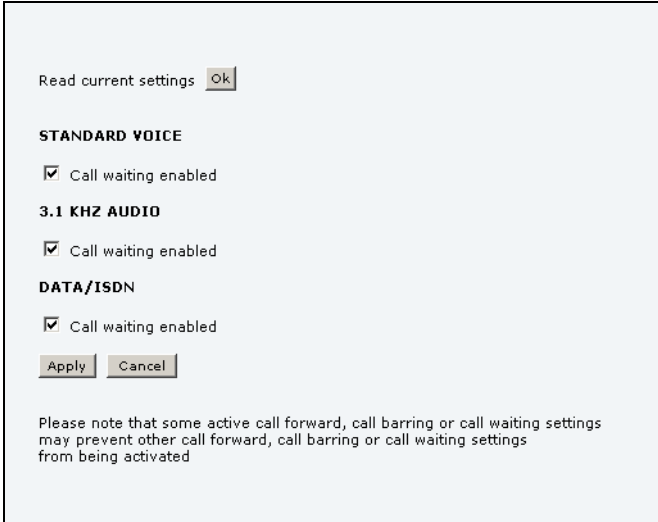

Read current settings

STANDARD VOICE

Call waiting enabled

3.1 KHZ AUDIO

Call waiting enabled

DATA/ISDN

Call waiting enabled

Please note that some active call forward, call barring or call waiting settings may prevent other call forward, call barring or call waiting settings from being activated

2. Click **OK** next to **Read current settings** to make sure the page is updated.
3. For each call type, select **Call waiting enabled** if you want to get notification of waiting calls while you are making a call or transmitting data.
4. Click **Apply**.

Line identification

You can set up the terminal to show your number when you are making a call or transmitting data.

Do as follows:

1. Select **SETTINGS > Common > Line identification** from the left navigation pane.

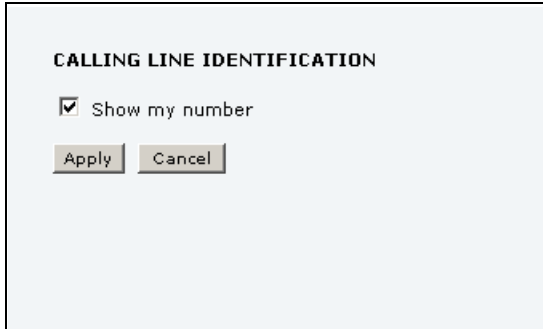

2. Select **Show my number** and click **Apply**.

Closed user group

Your subscription may include one or more closed user groups. A closed user group is a group of users permitted to make calls to each other but not to users outside the group.

To define the settings for these user groups, do as follows:

1. Select **SETTINGS > Common > Closed user group** from the left navigation pane.

GROUPS		
Group index	Active	Group no.
0	<input type="radio"/>	<input type="text" value="0"/>
1	<input type="radio"/>	<input type="text" value="0"/>
2	<input type="radio"/>	<input type="text" value="0"/>
3	<input type="radio"/>	<input type="text" value="0"/>
4	<input type="radio"/>	<input type="text" value="0"/>
5	<input type="radio"/>	<input type="text" value="0"/>
6	<input type="radio"/>	<input type="text" value="0"/>
7	<input type="radio"/>	<input type="text" value="0"/>
8	<input type="radio"/>	<input type="text" value="0"/>
9	<input type="radio"/>	<input type="text" value="0"/>
10	<input checked="" type="radio"/>	Subscribed

SETTINGS FOR ACTIVE CLOSED USER GROUP

These settings are not used for subscribed closed user group

Outgoing Access Preferential

2. Type in your user group number(s) under **Group no.**
Your airtime subscription lists your user group number(s).
3. Select which group should be active.
If you select **Subscribed**, the group(s) included in your subscription will be active.

4. To allow outgoing access for the activated user group, select **Outgoing Access** under **SETTINGS FOR ACTIVE CLOSED USER GROUP**. Note that if you selected Subscribed above, this setting will not be used.
5. Select **Preferential** if you want the activated user group to be selected when a member of a user group does not specify the group number during call set up. Note that if you selected Subscribed above, this setting will not be used.
6. Click **Apply**.

Setting up the local exchange function

If the local exchange is not used, the default behavior is such that incoming calls will cause all connected phones to ring. If you want to be able to call a specific phone connected to the terminal and you are not using additional numbers in your subscription, you must use the local exchange function. With this function enabled, when you dial the mobile number of the terminal, a recorded message guides you to dial the number for the local phone you want to call. Your call is then transferred to the requested phone.

Note

If Multi-voice is enabled, the local exchange function is not available.

To set up the local exchange, do as follows:

1. Select **SETTINGS > Common > Local exchange** from the left navigation pane.

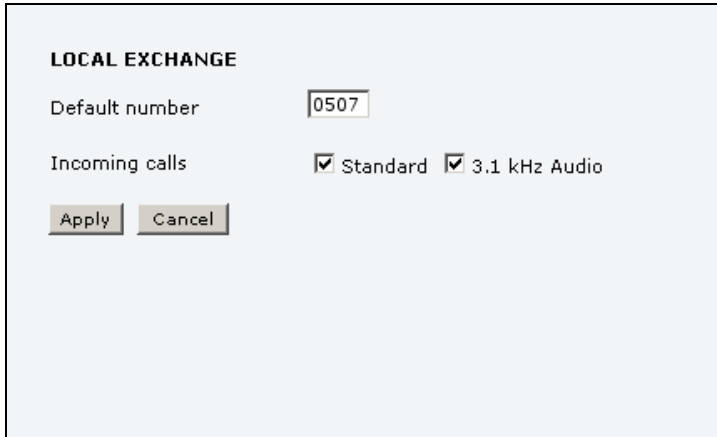

The screenshot shows a configuration window titled "LOCAL EXCHANGE". It contains the following elements:

- A label "Default number" followed by a text input field containing the value "0507".
- A label "Incoming calls" followed by two checked checkboxes: "Standard" and "3.1 kHz Audio".
- At the bottom, there are two buttons: "Apply" and "Cancel".

2. Type in the default number.
Incoming calls are transferred to this local number if
 - the caller dials * after calling the mobile number, or
 - the caller dials nothing after the recorded message.
3. Select the call types you want to direct to the local exchange.
For example, if you use 3.1 kHz Audio for a fax machine only, you do not want to use the local exchange for 3.1 kHz Audio.
If no call type is selected, the local exchange function is disabled.
4. Click **Apply**.

To manage IP handsets

Overview

The terminal has 4 LAN (PoE) connectors for connection of IP handsets or other IP equipment. You may connect your IP handsets directly to the LAN interfaces or use a PoE switch to connect more handsets. The SAILOR FleetBroadband terminal supports connection of up to 16 handsets.

Each handset must have a local number in the range 0501 to 0516 as well as a unique password. By default, handset numbers are automatically assigned when IP Handsets from Cobham SATCOM are connected. However, you may want to change the password for the handset. For further information, see the next section *To connect and configure IP handsets*.

Note

The handset with the local number 0501 is the master handset. This means you can start/stop data sessions from the terminal with this handset, if the function is allowed in the User permissions page. See *To set up user permissions* on page 182.

Note that if you **do not want your IP Handsets to automatically be assigned** a local number and password, you can clear the setting **Settings > Start up options > Auto BGAN SIP** in the IP Handset menu. This is recommended if you are going to use Voice Distress or Multi-voice with assigned numbers. See *Voice Distress* on page 192 and *Additional numbers for Multi-voice* on page 61.

To connect and configure IP handsets

Note

An IP Handset from Cobham SATCOM that is connected to the LAN interface on the terminal is by default automatically registered in the terminal and assigned the first available local number and a password, which is the same number as the local number.

If you want to view or change the settings for the new IP handset, do as follows:

1. Connect the IP handset to one of the LAN ports of the terminal.
If it is an IP Handset from Cobham SATCOM, the handset starts up and is automatically registered and assigned the first available number.
2. In the web interface, select **SETTINGS > IP handsets**.

Entry	Number	Handset password	Actions	Configure handset
1	0501	0501	Edit	Configure
2	0502	0502	Edit	Unreserved
3	0503	0503	Edit	Unreserved
4	0504	0504	Edit	Unreserved
5	0505	0505	Edit	Unreserved
6	0506	0506	Edit	Unreserved
7	0507	0507	Edit	Unreserved
8	0508	0508	Edit	Unreserved
9	0509	0509	Edit	Unreserved
10	0510	0510	Edit	Unreserved
11	0511	0511	Edit	Unreserved
12	0512	0512	Edit	Unreserved
13	0513	0513	Edit	Unreserved
14	0514	0514	Edit	Unreserved
15	0515	0515	Edit	Unreserved
16	0516	0516	Edit	Unreserved

3. If you want to change the password, click **Edit** next to the number you want to use.
4. Enter the password you want for your IP handset.

Note

The IP Handset from Cobham SATCOM only supports numbers (no letters) in the password.

5. In the IP handset, enter the local number and the password you just entered in the web interface. For the IP Handset from Cobham SATCOM do as follows:
 - a. In the IP Handset, enter the menu system (select **Menu**) and select **SIP** to get the list of profiles.
 - b. Select the **BGAN** profile and select **Options** (left softkey).
 - c. Select **Edit/View** and change the user name and password.

Note that the user name is also the local number for the handset.

If you have another IP handset, refer to the manufacturer documentation.

Note

For 3rd party handsets: Silence supp Enable must be set to **no** in your IP handset. The phone should not stop sending data packets even though there is silence and no one speaks.

6. For IP Handsets from Cobham SATCOM: When the terminal and the handset have recognized each other, a **Configure** link appears next to the handset in the list.
7. Select **Configure** next to an IP Handset to access the built-in web interface of the IP Handset.

The web interface of the IP Handset opens. It is very similar to the web interface of the terminal, but has a handset icon in the top left corner.

With the web interface of the IP Handset you can access the internal settings of the IP Handset. For further information, refer to the user manual for the IP Handset.

The handset remains in the list after it is disconnected. When the handset is connected again, it is automatically recognized and ready for use.

Entry	Number	Handset password	Actions	Configure handset
1	0501	0501	Edit/Release	Reserved
2	0502	0502	Edit	Unreserved
3	0503	0503	Edit	Unreserved
4	0504	0504	Edit	Unreserved

If you want to remove the handset from the list, click **Release** under **Actions** (the Release link only appears when the handset is disconnected).

To set the call types for IP handsets

In the Call settings page you can set the call types for each local number and see whether Restricted dialing is enabled for that number. For further information on Restricted dialing, see *Restricted dialing* on page 189.

To set the call types for IP handsets, do as follows:

1. Select **SETTINGS > IP handsets > Call settings**.

Number	Incoming calls	Assigned number	Outgoing calls	Restricted dialing
0501	<input checked="" type="checkbox"/> Standard <input checked="" type="checkbox"/> 3.1 kHz Audio	<input type="text"/>	<input checked="" type="radio"/> Standard <input type="radio"/> 3.1 kHz Audio	Enabled
0502	<input checked="" type="checkbox"/> Standard <input checked="" type="checkbox"/> 3.1 kHz Audio	+870772100114	<input checked="" type="radio"/> Standard <input type="radio"/> 3.1 kHz Audio	Enabled
0503	<input checked="" type="checkbox"/> Standard <input type="checkbox"/> 3.1 kHz Audio	<input type="text"/>	<input checked="" type="radio"/> Standard <input type="radio"/> 3.1 kHz Audio	Enabled
0504	<input type="checkbox"/> Standard <input type="checkbox"/> 3.1 kHz Audio	<input type="text"/>	<input checked="" type="radio"/> Standard <input type="radio"/> 3.1 kHz Audio	Enabled
0505	<input checked="" type="checkbox"/> Standard <input checked="" type="checkbox"/> 3.1 kHz Audio	<input type="text"/>	<input checked="" type="radio"/> Standard <input type="radio"/> 3.1 kHz Audio	Enabled
0506	<input checked="" type="checkbox"/> Standard <input checked="" type="checkbox"/> 3.1 kHz Audio	<input type="text"/>	<input checked="" type="radio"/> Standard <input type="radio"/> 3.1 kHz Audio	Enabled
0507	<input checked="" type="checkbox"/> Standard <input checked="" type="checkbox"/> 3.1 kHz Audio	<input type="text"/>	<input checked="" type="radio"/> Standard <input type="radio"/> 3.1 kHz Audio	Enabled
0508	<input checked="" type="checkbox"/> Standard <input checked="" type="checkbox"/> 3.1 kHz Audio	<input type="text"/>	<input checked="" type="radio"/> Standard <input type="radio"/> 3.1 kHz Audio	Enabled
0509	<input checked="" type="checkbox"/> Standard <input checked="" type="checkbox"/> 3.1 kHz Audio	<input type="text"/>	<input checked="" type="radio"/> Standard <input type="radio"/> 3.1 kHz Audio	Enabled
0510	<input checked="" type="checkbox"/> Standard <input checked="" type="checkbox"/> 3.1 kHz Audio	<input type="text"/>	<input checked="" type="radio"/> Standard <input type="radio"/> 3.1 kHz Audio	Enabled
0511	<input checked="" type="checkbox"/> Standard <input checked="" type="checkbox"/> 3.1 kHz Audio	<input type="text"/>	<input checked="" type="radio"/> Standard <input type="radio"/> 3.1 kHz Audio	Enabled
0512	<input checked="" type="checkbox"/> Standard <input checked="" type="checkbox"/> 3.1 kHz Audio	<input type="text"/>	<input checked="" type="radio"/> Standard <input type="radio"/> 3.1 kHz Audio	Enabled
0513	<input checked="" type="checkbox"/> Standard <input checked="" type="checkbox"/> 3.1 kHz Audio	<input type="text"/>	<input checked="" type="radio"/> Standard <input type="radio"/> 3.1 kHz Audio	Enabled
0514	<input checked="" type="checkbox"/> Standard <input checked="" type="checkbox"/> 3.1 kHz Audio	<input type="text"/>	<input checked="" type="radio"/> Standard <input type="radio"/> 3.1 kHz Audio	Enabled
0515	<input checked="" type="checkbox"/> Standard <input checked="" type="checkbox"/> 3.1 kHz Audio	<input type="text"/>	<input checked="" type="radio"/> Standard <input type="radio"/> 3.1 kHz Audio	Enabled
0516	<input checked="" type="checkbox"/> Standard <input checked="" type="checkbox"/> 3.1 kHz Audio	<input type="text"/>	<input checked="" type="radio"/> Standard <input type="radio"/> 3.1 kHz Audio	Enabled

2. If you have additional numbers from your airtime provider and you want to assign them to the IP handsets, use the **Assigned number** drop down list to select the number you want to use for each handset. When this number is called, only the assigned handset will ring.

Note

To be able to use the additional numbers, you must first select **Use additional numbers** in the **Multi-voice** page and enter the additional numbers under **PHONE BOOK > Mobile numbers**. See *Multi-voice* on page 191.

3. For each handset, select the call types you want to enable for incoming and outgoing calls.
The call types are described in more detail in *To select the call type* on page 43.
 - For **Incoming calls**, you can select Standard or 3.1 kHz Audio or both.
If you select both, the handset will react (ring) on any incoming call. If, for example, you select Standard, the handset will only react on calls made to the Standard phone number.
 - For **Outgoing calls**, you can select either Standard or 3.1 kHz Audio. The selected type will be used by default, if possible, for any outgoing call.
4. Click **Apply**.

To set up the IP Handset compatibility

Note | This setting only applies to the IP Handset from Cobham SATCOM.

If you connect your IP Handset(s) to the terminal through a separate router with NAT, you must use IP Handsets with software version 1.8 or newer and set up the handset compatibility in the web interface of the terminal as described below.

To see the software version of your IP Handset, select **MENU > Status > Software version** in the IP Handset.

To change the IP Handset compatibility, do as follows:

1. Select **Settings > IP handsets > Server settings**.

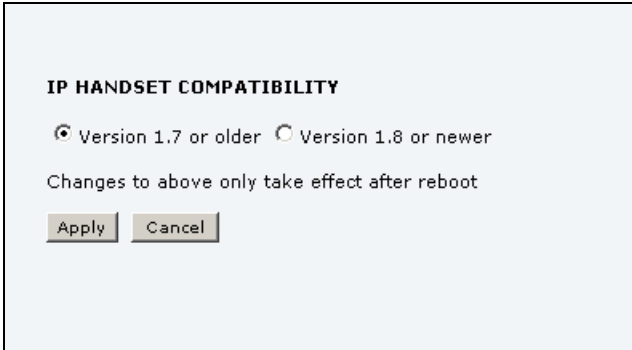

IP HANDSET COMPATIBILITY

Version 1.7 or older Version 1.8 or newer

Changes to above only take effect after reboot

2. Select the IP Handset compatibility as follows:
 - If you connect your IP Handset(s) through a separate router with NAT, select **Version 1.8 or newer** and use IP Handsets with software version 1.8 or newer.
 - If you connect your IP Handset(s) directly to the terminal or through a switch without NAT, select Version 1.7 or older. In this case you can use IP Handsets with any software version.

To configure the discrete I/O interface

I/O pins and their functions

The I/O interface on the terminal has 5 configurable I/O pins. You can set up the function of each pin in the web interface. The default functions of the I/O pins are as follows:

Output pins 1,2 and 3:

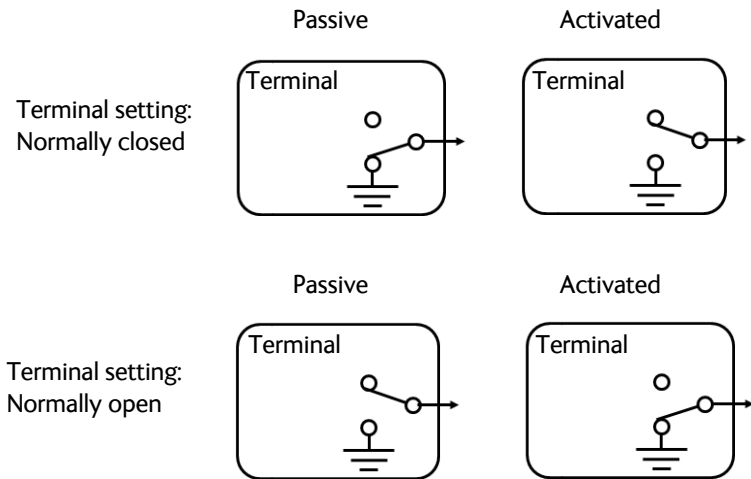

Pin 1: Ringer output.

Pin 1 acts as a built-in switch in the terminal. You can configure Pin 1 to be Normally closed or Normally open.

Note

Do not use the Ringer output if you have enabled Local exchange. For information on Local exchange, refer to *Setting up the local exchange function* on page 125.

- Normally closed (default):
The internal switch at pin 1 is normally closed (pin 1 is connected to ground). When the terminal is notified of an incoming call from the satellite interface, the switch opens (no connection to ground). When the call is answered, or the caller gives up and releases the call, the switch is closed again.

- **Normally Open:**
The internal switch at pin 1 is normally open (no connection to ground). When the terminal is notified of an incoming call from the satellite interface, the switch is closed (pin 1 is connected to ground). When the call is answered, or the caller gives up and releases the call, the switch is opened again.

Pin 2: Warning/Error output.

Pin 2 acts as a built-in switch in the terminal. Pin 2 can be used to provide an external signal that indicates active warning/error condition(s). You can configure pin 2 to be Normally closed or Normally open.

- **Normally Closed (default):**
The internal switch at pin 2 is normally closed (pin 2 is connected to ground). When an alarm occurs, the switch opens (no connection to ground). The switch is closed again when all warnings/errors are cleared.
- **Normally Open:**
The internal switch at pin 2 is normally open (no connection to ground). When an alarm occurs, the switch is closed (connected to ground). The switch is opened again when all warnings/errors are cleared.

Pin 3: Mute output.

Pin 3 acts as a built-in switch in the terminal. Pin 3 can be used to provide an external signal that is active during a phone call. The signal can be used to mute external equipment. You can configure pin 3 to Normally closed or Normally open.

- **Normally Closed (default):**
The internal switch at pin 3 is normally closed (pin 3 is connected to ground). During phone calls, the switch opens (no connection to ground). When the call is ended, the switch is closed again (connected to ground).
- **Normally Open:**
The internal switch at pin 3 is normally open (no connection to ground). The switch is closed (connected to ground) during phone calls. When the call is ended, the switch opens again (no connection to ground).

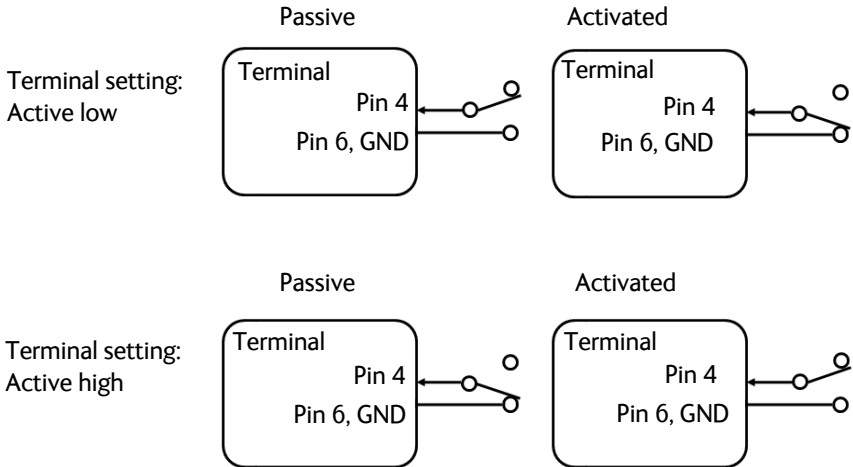
Input pin 4:**Pin 4: Radio silence input.**

Activation of this pin causes the system to assume radio silence, i.e. to stop all transmission from the system. The terminal gracefully closes all open connections, and deregisters from the BGAN network. No transmission is allowed until the pin is deactivated. You can configure pin 4 to Active low or Active high.

- Active low (default): Connect pin 4 to ground (< 1.2 V DC) when it should be activated.
- Active high: Connect pin 4 to ground (< 1.2 V DC). When it should be activated, disconnect it from ground.

Input pin 5/8 (example):

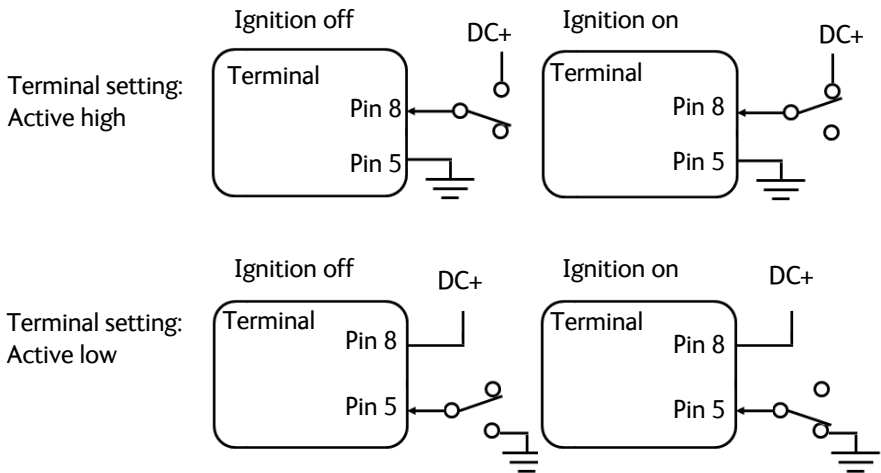

Pin 5/8: Ignition input.

The ignition function can be used to turn on/off the terminal by means of an external signal. The external signal that triggers the ignition function can be either positive DC voltage or ground. The ignition function uses pin 5 together with pin 8 (DC in). Connect the appropriate pin to the ignition switch as follows:

- Active high (default): Connect pin 5 permanently to Ground. Connect pin 8 to positive DC voltage (10.5-32 V DC) when the ignition is on. To switch off, disconnect pin 8 from the positive DC voltage.
- Active low: Connect pin 8 permanently to positive DC voltage (10.5-32 V DC). Connect pin 5 to Ground (< 1.2 V DC) when the ignition is on. To switch off, disconnect pin 5 from ground.

Note

The Ignition function is normally not used in maritime installations. You may use the Remote on/off function in the power connector instead.

Pin 6: Ground.

(Non-configurable) Pin 6 can be used as an external connection to ground. Pin 6 is connected to Ground inside the terminal.

Pin 7: DC output.

(Non-configurable) Pin 7 can be used as a DC output. The voltage on pin 7 is 9-15 V and the output can supply up to 50 mA. Pin 7 can be used as power supply to a relay, ringer or similar.

To configure the I/O interface

To configure the I/O pins, do as follows:

1. Select **SETTINGS > Discrete I/O**.

DISCRETE I/O

Pin	I/O	Function	Enabled	Polarity
1	Output	Ringer	<input type="checkbox"/>	<input type="radio"/> Normally closed <input checked="" type="radio"/> Normally open
2	Output	Warning	<input type="checkbox"/>	<input type="radio"/> Normally closed <input checked="" type="radio"/> Normally open
3	Output	Mute	<input type="checkbox"/>	<input type="radio"/> Normally closed <input checked="" type="radio"/> Normally open
4	Input	Radio silence	<input type="checkbox"/>	<input type="radio"/> Active high <input checked="" type="radio"/> Active low
5	Input	Ignition	<input type="checkbox"/>	<input checked="" type="radio"/> Active high <input type="radio"/> Active low

DELAYED SHUTDOWN

Delay (Minutes)

RINGER OUTPUT

Incoming calls Standard 3.1 kHz Audio UDI RDI

MUTE OUTPUT

Calls Standard 3.1 kHz Audio UDI RDI

2. For each pin you want to use, select **Enabled**.
3. For each pin, select the function of the pin. Refer to the previous section, *I/O pins and their functions* on page 133.
4. If you use the Ignition function and you want the terminal to stay on for a few minutes after the Ignition is switched off, enter the number of minutes under **DELAYED SHUTDOWN**.

For further information on the Ignition function, see *To use the ignition system* on page 23.

5. If you use a ringer output, select the incoming call types that should activate the ringer under **RINGER OUTPUT**.
6. If you use a Mute output, select the call types (both incoming and outgoing) that should activate the Mute function under **MUTE OUTPUT**.
7. Click **Apply**.

To set up Tracking

The SAILOR FleetBroadband system can be used for tracking purposes. You can set up the terminal to report to a server at certain time intervals or after moving a specified distance.

To set up tracking, do as follows:

1. Select **SETTINGS > Tracking**.
(continued on next page)

SERVER CONNECTION

Server IP address

Server port

Client port

Encryption key

Allow remote control Yes No

APN

Common

SIM default

Network assigned

User defined

User name

Password

POSITION REPORTS

Report type Compressed

Extended

ECEF

INTERVAL REPORT

Status Enabled Disabled

Report each : (hh:mm)

DISTANCE REPORT

Status Enabled Disabled

When moved meters

Max one report per : (hh:mm)

2. Type in the **Server IP address**, **Server port**, **Client port** and **Encryption key** for your server connection.

- **IP address.** The IP address of the server that the SAILOR FleetBroadband terminal will report to.
 - **Server port.** Port number on the server. Default number is 7474.
 - **Client port.** Port number on the SAILOR FleetBroadband terminal. Default number is 7475.
 - **Encryption key.** A supplied 128 bit key which must match on both the client and server side.
3. To allow remote control of the tracking settings from the tracking server, select **Yes** at **Allow remote control**.
This means the SAILOR FleetBroadband terminal will accept commands from the specified tracking server, for example to change reporting intervals or start/stop reporting.
4. Select the **APN** to use for Tracking and enter the user name and password if required. You have the following options for the APN:
- **Common.** The APN is taken from the Common APN defined under **SETTINGS > Common**. Refer to *Common interface settings* on page 117.
 - **SIM default.** The APN is taken from the SIM card. This is the recommended option, unless you have special requirements.
 - **Network assigned.** The APN is assigned from the network.
 - **User defined.** Type in the APN. APNs are provided from the Airtime Provider.
5. Under **Position reports**, select the report type you want to use.
- **Compressed.** Only latitude and longitude are reported.
 - **Extended.** Apart from latitude and longitude, heading and altitude are also included.
 - **ECEF.** The same information as Extended, but position and speed data are 3D (ECEF coordinates).
6. Under **Interval report**, select **Enabled** or **Disabled** and type in the interval between the reports.
7. Under **Distance report**, select **Enabled** or **Disabled** and type in the following:

- **When moved.** Enter the distance the vessel should be moved before the SAILOR FleetBroadband sends a report.
- **Max one report per.** Enter the minimum time that should pass between two reports.

Example: The distance is set to 1000 m and the time is set to 15 minutes. The SAILOR FleetBroadband system has moved 1000 m since last report, but only 5 minutes have passed. A report will not be sent until 15 minutes have passed.

8. Click **Apply**.

To manage LAN network users

Introduction

The network management system

With the built-in router functionality the system offers a flexible use of the data channel of the BGAN service. You can configure the use of the data channel by defining network user groups and profiles. The following picture gives an overview of the parameters involved.

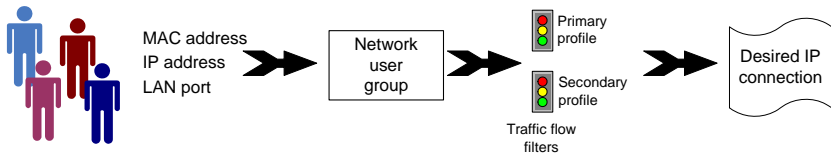

The network user group you belong to is determined by one or more of the following:

- the IP address of the device you are using
- the MAC address of the device you are using
- the LAN port you connect to

A connected IP device will automatically be assigned to the default network user group, if it is not specified otherwise.

For specific purposes like video streaming, a server on the network, a fixed IP address on the connected device or changing the startup mode of a connection, you must set up network groups with specific primary and/or secondary profiles. How to do this is described in the following sections.

Network user groups

The network management system divides the users of the terminal into network user groups. Each network user group has a profile which determines how the users connect to the Inmarsat BGAN network. The network user groups can allow or restrict certain services for different users.

For example, you may want to define:

- one network user group allowing both Standard and Streaming connections,
- one network user group for Internet, e-mail and VPN, allowing Standard connections,
- one network user group for Remote management of systems. This would be a direct Standard connection (Bridge mode).

You can have up to 11 network user groups and global IP addresses.

Necessary steps when you manage network users

The steps necessary for managing network users include:

1. **To define a network user group.** See *To set up the network user groups* on page 144.

The network user groups determine settings such as:

- QoS (Standard/Streaming),
- IP addressing (Static/Dynamic)
- Internet access mode (Router Mode/Bridge Mode/No Internet Access)

2. **Identify a network device.** See *To manage network devices* on page 150.

The network devices are identified by their IP address, MAC address and (optionally) device name.

3. **Associate the network user group and the network device.** See *To use the network classification table* on page 152.

The network classification table determines which devices should belong to which network user group. When a network device is connected, the terminal runs through the network classification table to check if the new connection matches any of the entries in the table. When a match is found, the terminal establishes a packet data connection (PDP context) with the settings defined in the belonging network user group, and the device is ready for use with the terminal.

Access to the network management settings

Access to the network management settings requires an administrator password. The default user name is **admin** and the default password is **1234**.

The administrator can create and manage network user groups and set up a network classification table defining priorities for devices, network user groups and LAN ports.

Important

All user connections to the LAN interface may be affected when you change the settings below, including your own current connection.

To set up the network user groups

Overview

A network user group, in this context, is a group of network users who share the same Quality of Service profile and network parameters.

There are 11 configurable network user groups. For the Default network user group certain settings are locked to make sure there is always one functional network user group available. For example, the Default network user group cannot be disabled and does not allow you to select a Bridge mode connection.

Note

The network user groups cannot be deleted. If you do not want to use them, click **Edit** and select **Disabled** at **Status** in the **NETWORK USER GROUP** field.

To edit a network user group

For further explanation of the terms used below, see *Definitions for network terms* on page 155.

To edit a network user group, do as follows:

1. Select **SETTINGS > LAN > Network user groups**.

When you are prompted, enter the administrator user name and password. For details, see *To log on* on page 164.

NETWORK USER GROUPS				
Name	Status	Internet connection	Automatic activation	
Bridge comm	Enabled	Router mode	Disabled	Edit
Crew	Enabled	Router mode	Enabled	Edit
IP Handsets	Enabled	No internet access	Enabled	Edit
Engine room	Enabled	Bridge mode	Enabled	Edit
Group 4	Disabled	Router mode	Disabled	Edit
Group 5	Disabled	Router mode	Disabled	Edit
Group 6	Disabled	Router mode	Disabled	Edit
Group 7	Disabled	Router mode	Disabled	Edit
Group 8	Disabled	Router mode	Disabled	Edit
Group 9	Disabled	Router mode	Disabled	Edit
Default group	Enabled	Router mode	Disabled	Edit

2. Click **Edit** next to the network user group you want to set up.

DASHBOARD

CONNECT

PHONE BOOK

MESSAGES

CALLS

SETTINGS

LAN

Port forwarding

Network devices

Network classification

Network user groups

PPPoE

Static route

Phone/Fax

ISDN

Common

IP handsets

Discrete I/O

Tracking

Upload

Satellite selection

Language

ADMINISTRATION

HELPDESK

SITE MAP

NETWORK USER GROUP

Name

Status Enabled Disabled

Internet connection

Changes to Status and Internet connection only take effect after reboot

TCP/IP

Dynamic IP address

Static IP address

IP Header compression Enabled Disabled

APN

Common

SIM default

Network assigned

User defined

User name

Password

PROFILES

Automatic activation Enabled Disabled

Primary

If using secondary profiles, remember to set a traffic flow filter for each profile

Secondary

PROFILE CIDS

Profile	Cid
Standard	1
Streaming 32	3
Streaming 64	4
Streaming 128	5
Streaming 256	9

3. Type in a name for the group.

4. Select **Enabled** or **Disabled**.
5. Select the type of **Internet connection**. (See drawing on page 104)
 - **Router mode** means the connection will be shared with other users, and the NAT module of the terminal will make the necessary address translations. Use this mode if one or more computers are connected using the LAN interface, and the terminal should act as a router.
 - **Bridge mode** is an exclusive connection, with NAT disabled. Use this mode together with a network classification entry that selects a single computer (see *To use the network classification table* on page 152). This mode is not available in the Default network user group.
 - **No Internet access** means no connection to the Internet is allowed. Use this setting e.g. for IP handsets, where an Internet connection is not required. The external voice connection is still available; this setting only affects communication over the Internet.

6. Select **Dynamic IP address**.

This is the IP address used externally on the satellite network. See next step for Static IP.

7. If you want to use a **static IP address**, you must have the static IP address included in your airtime subscription and use that address as follows:
 - Leave the setting in step 6 at **Dynamic, do not select Static IP**.
 - Select **SIM default** in step 9
 - Type in the APN user name and password from your provider in step 10

Your terminal will then use the static IP address set up for your SIM card.

Note

Static IP is handled by the service provider. **Do not type in a static IP address** in the Static IP address field; a manually typed IP address will currently not be used by the network.

8. Set **IP Header compression** to **Enabled** or **Disabled**.

For information on IP Header compression, see *Header compression* on page 155.

9. Select the source of the **APN** (Access Point Name).

There are four options for setting the APN. Unless you have special requirements, it is recommended to use the SIM default, or to set the common APN to SIM default, and then select Common here. You have the following options:

- **Common.** The APN is taken from the Common APN defined under **SETTINGS > Common**. Refer to *Common interface settings* on page 117.
- **SIM default.** The APN is taken from the SIM card. If you want to use a static IP address on the external network, select this option either here or in the Common setting.
- **Network assigned.** The APN is assigned from the network.
- **User defined.** Type in the APN. APNs are provided from the Airtime Provider.

10. If your APN uses a password, type in the user name and password provided from the Airtime Provider.

Note

If you are going to use the static IP address from your SIM card, the user name and password are mandatory! See step 6 above.

11. At **Automatic activation** select whether the profile selected in the next step should be activated automatically or manually.

Note

If the selected primary profile is a Streaming profile, this setting has no effect. Streaming profiles must always be activated manually from the Dashboard.

- **Disabled** means you can activate/deactivate the profile from the Dashboard.
- **Enabled** means the profile is activated automatically as soon as the system is ready.

12. Select the **Primary profile**.

Select a profile from the **Primary** scroll list. This profile is used by this network user group as a first choice, when possible.

Important

If you have selected and started a Streaming connection as your primary profile, the LAN interface will be running a Streaming connection until you stop it or disconnect the interface. However, if you select one or more secondary profiles, you can set up your traffic flow filter so that it will only use the Streaming profile for certain types of traffic.

There are several predefined profiles: Standard, Streaming 8 kbps, Streaming 16 kbps, Streaming 32 kbps, Streaming 64 kbps, Streaming 128 kbps and Streaming 256 kbps (only SAILOR 500 FleetBroadband). Additionally, you can define your own custom profiles.

For further information on profiles and traffic flow filters, see *To use profiles* on page 171 and *To use traffic flow filters* on page 176.

13. Select the **Secondary profile**.

To select more than one secondary profile, press and hold **Ctrl** or **Shift** while you select additional profiles.

Note

If you have selected both a primary and one or more secondary profiles you must define a traffic flow filter before you can establish a valid connection.

The Context Identifiers (CIDs) for the selected primary and secondary profiles are listed under **Profile CIDs**.

14. Click **Apply**.

To manage network devices

Overview

A network device, in this context, is an Ethernet hardware device, identified by its unique MAC address.

When a network device with dynamic IP address is connected to the terminal, it is automatically listed in the Network devices list.

To view the list of network devices

To view the list of network devices, select **SETTINGS > LAN > Network devices**.

If you are prompted, enter the administrator user name and password. For details, see *To log on* on page 164.

All network devices that have been connected to the terminal are listed here.

LOCKED IP ADDRESSES			
IP address	MAC address		
192.168.11.4	00:18:F8:09:09:09		Delete
192.168.11.11	00:18:F8:09:BF:0A		Delete
192.168.11.12	00:18:F8:09:09:0C		Delete
NETWORK DEVICES			
IP address	MAC address	Device Name	
192.168.0.2	00:18:F8:09:BD:D4	device-0	Lock ip to mac address
192.168.11.1	00:18:F8:09:09:06	device-1	Lock ip to mac address
192.168.11.2	00:18:F8:09:09:07	device-2	Lock ip to mac address
192.168.11.3	00:18:F8:09:09:08	device-3	Lock ip to mac address
192.168.11.4	00:18:F8:09:09:09	device-4	
192.168.11.5	00:18:F8:09:09:0A	device-5	Lock ip to mac address
192.168.11.6	00:18:F8:09:BF:07	device-6	Lock ip to mac address
192.168.11.7	00:18:F8:09:BF:05	device-7	Lock ip to mac address
192.168.11.8	00:18:F8:09:B8:07	device-8	Lock ip to mac address
192.168.11.9	00:18:F8:09:BF:03	device-9	Lock ip to mac address
192.168.11.10	00:18:F8:09:0A:07	device-10	Lock ip to mac address
192.168.11.11	00:18:F8:09:BF:0A	device-11	
192.168.11.12	00:18:F8:09:09:0C	device-12	

To lock an IP address to a MAC address

When the device is locked to an IP address, the terminal will always assign this IP address to the MAC address of this device (if DHCP is enabled and the Internet connection is not a Bridge mode connection).

To lock a device to its current IP address, click the link next to the device.

The device is then locked to the current IP address and added to the list of locked IP addresses at the top of the page.

To unlock a device from the IP address, click **Delete** next to the device in the **LOCKED IP ADDRESSES** list.

To use the network classification table

Overview

The network classification table is used to define which network devices, IP addresses and/or LAN ports are associated with which network user groups.

Each entry in the table shows MAC address, IP address, LAN port and network user group.

When a network device is connected, the terminal runs through the network classification table to check if the new connection matches MAC address, IP address and LAN port in any of the entries in the table. When a match is found, the terminal establishes a PDP context with the settings of the network user group assigned in the matching entry. The device is now ready for use with the terminal.

To add or edit an entry in the network classification table

To add a new entry to the table or to edit an existing entry, do as follows:

1. Select **SETTINGS > LAN > Network classification table**.

If you are prompted, enter the administrator user name and password. For details, see *To log on* on page 164.

NETWORK CLASSIFICATION TABLE				
MAC address	IP address	LAN port	Network user group	
*	*	1	Bridge comm	▼ Edit/Delete
*	*	2	Crew	▲/▼ Edit/Delete
*	*	3	IP Handsets	▲/▼ Edit/Delete
00:0F:1F:C1:7A:4C	*	4	Engine room	▲/▼ Edit/Delete
*	*	*	Default group	▲ Edit/Delete

[Add](#)

Changes to this page only take effect after reboot

The network classification table shows which devices are associated with which LAN ports and network user groups. An Asterisk (*) is a “wild card”, meaning that any value is accepted.

- Click **Edit** next to the entry you want to edit, or click **Add** at the bottom of the list.

EDIT ENTRY

Enter values below or select a device from the list of known network devices to use that as a template. If a field is left empty it will be considered a wild card

MAC address

IP address

LAN port

Network user group

NETWORK DEVICES

IP address	MAC address	Device Name	
192.168.0.2	00:18:F8:09:BD:D4	device-0	Add
192.168.11.1	00:18:F8:09:09:06	device-1	Add
192.168.11.2	00:18:F8:09:09:07	device-2	Add
192.168.11.3	00:18:F8:09:09:08	device-3	Add
192.168.11.4	00:18:F8:09:09:09	device-4	Add
192.168.11.5	00:18:F8:09:09:0A	device-5	Add

- Click **Add** next to a network device you want to use, or type in the MAC address manually at the top of the page.

Note

If you leave a field empty, it is the same as a “wild card” and it will be shown as an Asterisk in the Network classification table.

Unless you are using a Static IP address, the IP address field should always be left empty.

- Select the **LAN port** and **Network user group** you want to associate with the device.

Network user groups are created and defined in the Network user group page. See *To set up the network user groups* on page 144.

- Click **Apply**.

To remove an entry in the network classification table

In the **network classification table**, click **Delete** next to the entry you want to delete.

To change the priority in the network classification table

To change the priority of an entry, click the up or down arrow next to the entry.

NETWORK CLASSIFICATION TABLE					
MAC address	IP address	LAN port	Network user group		
*	*	1	Bridge comm	▼	Edit/Delete
*	*	2	Crew	▲/▼	Edit/Delete
*	*	3	IP Handsets	▲/▼	Edit/Delete
00:0F:1F:C1:7A:4C	*	4	Engine room	▲/▼	Edit/Delete
*	*	*	Default group	▲	Edit/Delete

[Add](#)

Changes to this page only take effect after reboot

Connections are evaluated in the order they are listed. The first entry (and **only** the first entry) that matches the properties of the connected device is applied, meaning that the connection will be using the settings of the network user group assigned to that entry.

The Default network user group is always last, so it is only used if none of the other entries match the properties of the connected device, or if the other network user groups are disabled.

Definitions for network terms

APN (Access Point Name)

APNs are provided from the Airtime Provider. They may also be defined on the SIM card

The APN is used by the network user to establish a connection to the required external network. This means that the terminal must know the APN in order to be able to connect to the external network.

Header compression

The Header of a data packet contains control information that belongs to that packet. The information in the Header can take up a considerable amount of bandwidth. In order to save bandwidth, you can use Header Compression, meaning you compress the header information and leave out some of the information.

You can select whether or not to use Header Compression for your data transmission.

- **Header Compression enabled:** Recommended for low-noise applications.
If you select Header Compression enabled, you will be using less bandwidth on header information, leaving more bandwidth for the actual payload.
- **Header Compression disabled:** Recommended in noisy environments.
If Header Compression is disabled, the system will be less sensitive to noise.

Profiles

A profile is a collection of Quality of Service (QoS) settings and other settings that define the mode in which data is transmitted on an interface. For example, a profile is used to define whether a connection should be a Standard or Streaming connection.

You can select between a number of predefined profiles or define your own profiles for your data transmission.

Note

If you have selected more than one profile (one primary and one or more secondary profiles) for an interface, you must define a traffic flow filter before you can establish a valid connection.

You need an administrator password to define profiles and traffic flow filters.

NAT (Network Address Translation)

NAT enables a local-area network to use one set of private IP addresses for internal traffic and an assigned or static IP address for external traffic. The built-in NAT module in the terminal makes all necessary address translations between the local-area traffic and the external traffic.

If more than one user is connected, you must select a network user group with **Router mode** to use the NAT of the terminal.

To start and stop data sessions for other user groups

The administrator can start and stop data sessions for all network user groups connected to the terminal.

To start or stop a data session, do as follows:

1. Select **CONNECT**.

When you are prompted, enter the administrator user name and password. For details, see *To log on* on page 164.

The screenshot shows a web interface with a left sidebar containing menu items: DASHBOARD, CONNECT, PHONE BOOK, MESSAGES, CALLS, SETTINGS, ADMINISTRATION, HELPDESK, and SITE MAP. The 'CONNECT' item is highlighted. The main content area has a header 'SIGNAL: [signal strength indicator]'. Below the header, the 'CONNECT' section is active, showing 'ONGOING DATA SESSIONS' with a table entry: 'Standard data (161.30.180.47) Default group'. Underneath, there are two sections: 'PROFILES ON LAN (GROUP 0)' with a link 'Start Streaming 128' and 'PROFILES ON LAN (DEFAULT GROUP)' with a link 'Stop Standard'. A 'Refresh' button is located below the second section.

2. Click on the session you want to start or stop.

Under **ONGOING DATA SESSIONS** at the top you can see which data sessions are currently active.

To upload software

Introduction

The next pages describe how to upload software from your computer to the terminal and how to download the latest software version from the Internet to your computer.

You can upload software from your computer to the terminal without the PIN. However, if your SIM card requires a PIN and the PIN is not entered, you must enter the Administration user name and password.

To upload software from your computer

To upload software from your computer to the terminal, do as follows:

1. Download the new software as described in the next section, or acquire the software from Cobham SATCOM and save it on your computer.
2. Open the web interface and do one of the following:
 - If the PIN has been accepted (or a PIN is not required), select **SETTINGS > Upload** from the left navigation pane.
 - If a PIN is required and the PIN has not been entered, select **ADMINISTRATION**, enter the Administration PIN and password and click **Logon**.
For details, see *To log on* on page 164.
Then select **Upload** from the left navigation pane.

The **UPLOAD** page opens.

CHECK FOR SOFTWARE UPDATES

Current software version 1.24

Latest available Not checked...

File size

UPLOAD SOFTWARE TO TERMINAL

Disclaimer for Downloading and Uploading software:
Please be informed that downloading and installing software from the Thrane & Thrane web portal is at your own risk. Thrane & Thrane is not to be held liable for any possible damage with respect to downloading and installing software to your SAILOR 500 FleetBroadband.

If you have problems or questions with respect to downloading software or uploading your terminal please be informed that you will have to contact the Thrane & Thrane distributor from where the terminal was purchased or contact your local Thrane & Thrane distributor.

Please be advised that you will not be able to contact Thrane & Thrane for end user support and that we always recommend that software upgrades are being carried out by official Thrane & Thrane distribution partners.

3. In the field **UPLOAD SOFTWARE TO TERMINAL**, click **Browse...**
4. Browse to the new software version and accept it.
5. Click the **Upload** button.

Note that the upload procedure takes a couple of minutes.

Note

When upload is done, your terminal automatically restarts with the new software.

To download software from the Internet

Important

The terminal uses your BGAN airtime subscription to download the new software from the Internet. Note that it can take several minutes to download the software.

To download the latest software from the Internet to the terminal, do as follows:

1. Make sure you have a connection to the Internet from your terminal.
2. Open the web interface and select **SETTINGS > Upload** from the left navigation pane.

The screenshot displays a web interface with two main sections. The first section, titled "CHECK FOR SOFTWARE UPDATES", shows the current software version as 1.24 and a "Check for updates" button. Below this, it indicates the latest available version is "Not checked..." and lists "File size". The second section, titled "UPLOAD SOFTWARE TO TERMINAL", features a file input field with a "Browse..." button and an "Upload" button. At the bottom, there is a disclaimer and additional information regarding software distribution and support.

CHECK FOR SOFTWARE UPDATES

Current software version 1.24

Latest available Not checked...

File size

UPLOAD SOFTWARE TO TERMINAL

Disclaimer for Downloading and Uploading software:
Please be informed that downloading and installing software from the Thrane & Thrane web portal is at your own risk. Thrane & Thrane is not to be held liable for any possible damage with respect to downloading and installing software to your SAILOR 500 FleetBroadband.

If you have problems or questions with respect to downloading software or uploading your terminal please be informed that you will have to contact the Thrane & Thrane distributor from where the terminal was purchased or contact your local Thrane & Thrane distributor.

Please be advised that you will not be able to contact Thrane & Thrane for end user support and that we always recommend that software upgrades are being carried out by official Thrane & Thrane distribution partners.

3. Click **Check for updates**.
The terminal will now connect to the Internet through the BGAN network, using your airtime subscription. It may take a minute or two to obtain the new software version.

When the new software version is found, the web interface shows the new software version and a link where you can download the software.

4. Click the link to download the new software to your computer.
After you have saved the software, follow the procedure in the previous section (*To upload software from your computer*) to upload the software from the computer to your terminal.

To select the preferred BGAN satellite

Overview

By default the terminal is set up to automatically find the most appropriate satellite to connect to (“Auto” mode). However, if you are located in an area with more than one BGAN satellite available, you can select the satellite you prefer to use when the terminal registers on the BGAN network.

To select the preferred BGAN satellite

To select the preferred BGAN satellite, do as follows:

1. Select **SETTINGS > Satellite selection** from the left navigation pane.

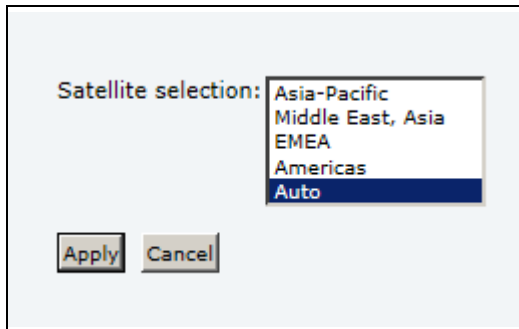

2. Select the satellite you prefer to use.
If you select **Auto** (the default setting) the SAILOR FleetBroadband System automatically uses the most appropriate satellite.

Important

If you have any ongoing calls or data sessions, they will be terminated when you click Apply!

3. Click **Apply**.
The SAILOR FleetBroadband terminates all ongoing connections and deregisters from the current satellite before it registers on the new satellite.

Note

If you have selected a satellite, your SAILOR FleetBroadband system will only try to establish a connection to the selected satellite. This means that if the antenna is outside the coverage area for that satellite, the SAILOR FleetBroadband system will not be able to register with the BGAN network.

To select the language

The default language of the web interface is **English**. You can change the language to **French, German, Russian, Spanish, Mandarin (Chinese)** or **Japanese**.

To change the language, do as follows:

1. Select **SETTINGS > Language**.



The screenshot shows a dialog box titled "LANGUAGE" with a light blue background. It contains a list of radio buttons for language selection: English (selected), Français, Deutsch, Русский, Español, 中文, and 日本語. At the bottom of the dialog are two buttons: "Apply" and "Cancel".

2. Select a language from the list.
3. Click **Apply**.

Administration

To access the administration settings

To log on

The Administration settings require an Administration user name and password. To log on as administrator, do as follows:

1. Select **ADMINISTRATION** from the left navigation pane.
2. Enter the Administration user name and password.

The default user name is **admin** and the default password is **1234**.





Caution! Change the administrator password after first logon! Otherwise anyone can access the terminal and interfere with your system and possibly your connected devices.

If you have forgotten the administrator password, you can click the link at the bottom of the page to reset the password. For further information, see the next section *To reset the administrator password*. The old user name and password will apply until you have finished the reset procedure.

3. Click **Logon**.

The Administration page is now updated to let you change the user name and password, Save/load a configuration or log off Administration.

To reset the administrator password

If you have forgotten the administrator password, do as follows:

1. Contact your supplier for a reset code.
Please report the serial number and IMEI number of the terminal.
You can find the serial number and IMEI number in the **Dashboard**.
2. Click the link **Forgot administrator password?** at the bottom of the ADMINISTRATOR LOGON page (see the previous section).

RESET ADMINISTRATOR PASSWORD

Reset code:

3. Type in the reset code obtained from your supplier and click **Reset**.

4. Type in the user name **admin** and the default password **1234**.
5. Click **Logon**.



Caution! Change the administrator password after first logon! Otherwise anyone can access the terminal and interfere with your system and possibly your connected devices.

For information on how to change the password, see the next section *To change the administrator password*.

To change the administrator password

To change the administrator password, do as follows:

1. After you have entered the administrator user name and password in the **ADMINISTRATION** page, locate the section **Change administrator logon**.

Please remember to log off after use

Change administrator logon

User name

New password

Retype new password

Configuration

Save configuration to file

Load configuration from file

Administrator logoff

2. Type in the existing user name.

3. Type in the new password and retype it on the next line.
4. Click **Change**.
At the next logon the new password is required.

To save a configuration to a file

If you need to reuse a configuration in another terminal of the same type and software version, you can save your current configuration to a file, which can then be loaded into the other terminal.

Note

Configuration files can only be exchanged between terminals with the same software version!

To save your current configuration to a file, do as follows:

1. In the **ADMINISTRATION** page, under **Configuration**, click **Save**.
2. Accept the default destination file name or type in the destination file name and location.
3. Click **OK**.
The configuration is now saved to a file. This file is used to load the configuration into another terminal. See the next section.

To load a configuration from a file

To load a configuration from a file, do as follows:

1. In the **ADMINISTRATION** page, under Configuration, click **Browse...**
2. Select the file you want to import and click **Open**.
3. Click **Load**.
The new configuration is now loaded into your terminal.

To log off administration

If you have not entered anything for 30 minutes under ADMINISTRATION, you are logged off automatically.

To log off manually, click **Logoff** under administrator logoff in the **ADMINISTRATION** page.

Call charges

If you know the tariff for your subscribed services, you can enter these tariffs in the web interface and automatically calculate the charges for your calls and data sessions.

Note

Cobham SATCOM does not take responsibility for the correctness of the estimated charges. This calculation is only a rough estimate of the charge, based on the tariff entered by the user. Also, the Airtime Provider may have different methods of measuring the airtime used.

To enter the call tariffs, do as follows:

1. From the left navigation pane, select **ADMINISTRATION > Call Charges**.

The billing details from your Inmarsat Service Provider can be entered below.

Currency:	<input type="text" value="EUR"/> (for display purposes only)
Standard voice: EUR	<input type="text" value="0.00"/> per minute
3.1 kHz Audio: EUR	<input type="text" value="0.00"/> per minute
Standard data: EUR	<input type="text" value="0.00"/> per MegaByte (1000 kB)
Streaming 8: EUR	<input type="text" value="0.00"/> per minute
Streaming 16: EUR	<input type="text" value="0.00"/> per minute
Streaming 32: EUR	<input type="text" value="0.00"/> per minute
Streaming 64: EUR	<input type="text" value="0.00"/> per minute
Streaming 128: EUR	<input type="text" value="0.00"/> per minute
Streaming 256: EUR	<input type="text" value="0.00"/> per minute

2. Select the currency from the **Currency** drop-down list.
3. Enter the tariff for each of the services.
4. Click **Apply**.

The entered tariffs are used to estimate the charges for calls and data sessions. The estimated charge is listed for each call or data session in the call log. For further information, see *To view the lists of calls and data sessions* on page 95.

Log handling

To clear the logs of the terminal and/or reset the counters for the time connected, do as follows:

1. From the left navigation pane in the **ADMINISTRATION** page, select **Log Handling**.

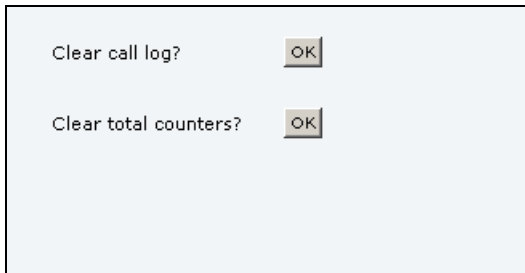

2. To clear the Call log, click **OK** next to **Clear call log?**
3. To clear the total counters, click **OK** next to **Clear total counters?**.
This will reset the **Time connected** counters on the Calls page.

Data limits

You can set a limit for the use of data services with the SAILOR FleetBroadband system. You either specify a maximum number of MB for the standard data connection, and/or a time interval from start to end for a streaming connection.

Once the entered limit is reached, the connection is automatically stopped. This is recorded in the menu **CALLS**, which contains a call log in which you can see information on standard and streaming data sessions. To continue using the data services you must click on the desired connection on the Dashboard to start a new connection.

Note

If you set a data limit for the Standard data connection, automatic activation of the Standard data connections is disabled for all network user groups.

To set data limits, do as follows:

4. From the left navigation pane in the **ADMINISTRATION** page, select **Data limits**.

		Estimated max charge
Standard data	<input type="checkbox"/> Close after 0 MB	0.00
Streaming 8	<input type="checkbox"/> Close after 0:30 hours	0.00
Streaming 16	<input type="checkbox"/> Close after 0:30 hours	0.00
Streaming 32	<input type="checkbox"/> Close after 0:30 hours	0.00
Streaming 64	<input type="checkbox"/> Close after 0:30 hours	0.00
Streaming 128	<input type="checkbox"/> Close after 0:30 hours	0.00
Streaming 256	<input type="checkbox"/> Close after 0:30 hours	0.00

Disclaimer: The estimated charges are based on the values entered on the Call Charges page. The values are only indicative and Thrane & Thrane cannot be held liable for any differences between these and your actual bill.

5. Select the services to close automatically after a fixed amount of data or period of time.

For Standard data type in the number of mega bytes (MB) allowed.
For streaming classes select a period of time from the drop down list.

6. Click **Apply** to save the settings.

If you have entered the call charges in the menu **Call charges**, the system automatically calculates and displays the maximum charges for your data sessions.

Note

Cobham SATCOM does not take responsibility for the correctness of the estimated charges. This calculation is only an estimate of the charge, based on the tariff entered by the user. The airtime provider may have different methods to calculate the charge.

To use profiles

What is a profile?

A profile is a collection of Quality of Service (QoS) settings and other settings that define the mode in which data is transmitted. For example, a profile is used to define whether the connection is a Streaming connection or a Standard connection.

You can select between a number of predefined profiles or define your own profiles for your data transmission.

If no traffic flow filters are defined, the Primary profile for a network user group is used for all traffic from that network user group. See *What are traffic flow filters?* in the next section.

For further information on profiles, refer to the 3GPP standard TS 23.107 “Quality of Service (QoS) concept and architecture”.

The profiles are used in the network user groups.

To select the profiles for a network user group

When you set up a network user group, you select the profiles to use for that network user group. You select a Primary profile and optionally one or more Secondary profiles. For details on how to select the profiles, see *To manage LAN network users* on page 142.

To define new profiles

When you define your profiles you can select **Subscribed** for many of the settings. If you select Subscribed, the value given in your Airtime subscription is automatically used.

Note

For SAILOR 250 FleetBroadband, the maximum Streaming bit rate is 128 kbps.

To define a new profile, do as follows:

1. From the left navigation pane, select **ADMINISTRATION > Profiles**.

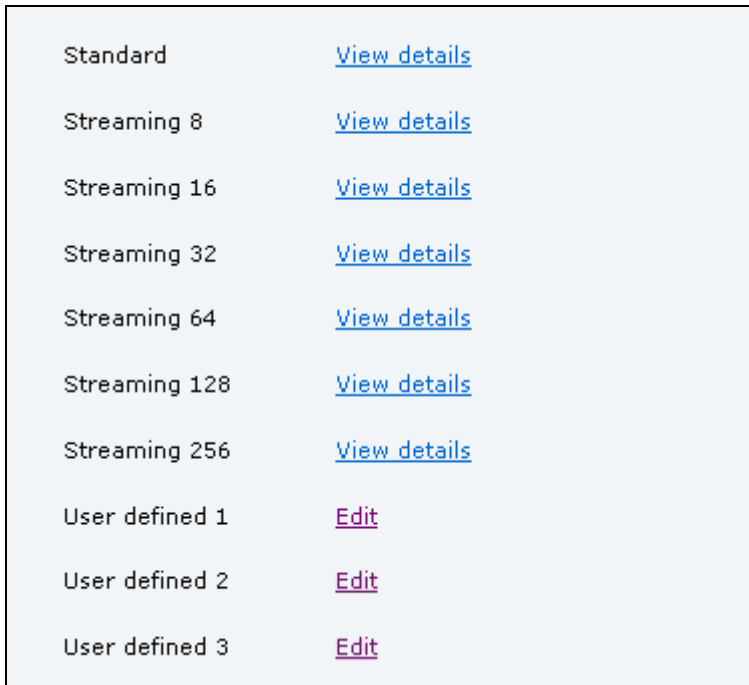

Standard	View details
Streaming 8	View details
Streaming 16	View details
Streaming 32	View details
Streaming 64	View details
Streaming 128	View details
Streaming 256	View details
User defined 1	Edit
User defined 2	Edit
User defined 3	Edit

2. Click **Edit** next to one of the user defined profiles.

Name	<input type="text" value="User defined 1"/>
Traffic class	<input type="text" value="Subscribed"/>
Maximum bit rate UI (kbps)	<input type="text" value="0"/>
Maximum bit rate DI (kbps)	<input type="text" value="0"/>
Guaranteed bit rate UI (kbps)	<input type="text" value="0"/>
Guaranteed bit rate DI (kbps)	<input type="text" value="0"/>
Delivery order	<input type="text" value="Subscribed"/>
Maximum SDU size (Byte)	<input type="text" value="0"/>
SDU error ratio	<input type="text" value="Subscribed"/>
Residual bit error ratio	<input type="text" value="Subscribed"/>
Delivery of erroneous SDUs	<input type="text" value="Subscribed"/>
Transfer delay (ms)	<input type="text" value="0"/>
Traffic handling priority	<input type="text" value="Subscribed"/>
<input type="button" value="Apply"/> <input type="button" value="Cancel"/>	

3. Fill in the name you want for your profile.
4. Select the **Traffic class** from the drop-down list.

Important

For best performance, choose the right traffic class for your application. In general, Standard IP (Background) is best suited for TCP/IP applications, and Streaming IP is best suited for UDP traffic, e.g. live video or audio.

You may select **subscribed** or one of the following:

- **Conversational** is real-time two-way conversation. It is primarily used for voice over IP and video conferencing.
- **Streaming** is real-time one-way communication. It is primarily used for video and audio.
- **Interactive** is two-way communication (not real-time). It is used for communication that is not very delay-sensitive, such as web browsing, database retrieval and server access. Examples of machines interaction with remote equipment are: polling for measurement records and automatic database enquiries (tele-machines).
- **Background** is used for data which is not delay-sensitive, such as E-mail, SMS, download of databases and reception of measurement records.

5. Type in the bit rates in kbps in the following fields:

Note

For SAILOR 250 FleetBroadband the maximum allowed bit rate is 128 kbps.

- **Maximum bit rate ul (kbps)** is the maximum upload bit rate allowed for this profile.
- **Maximum bit rate dl (kbps)** is the maximum download bit rate allowed for this profile.
- **Guaranteed bit rate ul (kbps)** is the guaranteed upload bit rate needed for this profile.
- **Guaranteed bit rate dl (kbps)** is the guaranteed download bit rate needed for this profile.

Note

When you click Apply, the bit rate values you typed in may be rounded off because only certain values are allowed.

6. In the **Delivery order** field, select from the scroll list whether or not data should be delivered in the same order it was sent. Yes means the data packets are delivered in the same order they were sent.
7. In the **Maximum SDU size (byte)** field, type in the maximum allowed packet size in Bytes (rounded off to nearest 10). The maximum packet size possible is 1520.

8. Select from the **SDU error ratio** drop-down list the fraction of a packet allowed to be lost or erroneous. Only used if you select **Yes** in step 10.
9. Select from the **Residual bit error ratio** drop-down list the undetected bit error ratio of a packet. If no error detection is requested, Residual bit error ratio indicates the bit error ratio in delivered packets.
10. In the **Delivery of erroneous SDUs** row, select one of the following from the list:
 - **Yes** means packets are allowed to contain errors. This setting is suitable for delay-sensitive transmission, because the need for retransmission is limited. The SDU Error settings in step 8 and step 9 will apply.
 - **No** means packets are not allowed to contain errors, and the SDU Error setting in step 8 will **not** be applied. This setting is suitable where error-free transmission is important and delays are accepted.
 - **No detect** means that errors will not be detected, and the SDU Error setting in step 8 will **not** be applied.
11. In the **Transfer delay (ms)** field, type in the delay in ms. This is the delay from the time data is received in the terminal until it arrives at the receiving end.
 - If the Transfer delay is 500 ms, error correction is disabled.
 - If the Transfer delay is 4000 ms, error correction is applied.
12. In the **Traffic handling priority** row, select from the drop-down list which priority this connection should have.
13. Click **Apply**.

The new profile is now added, and can be selected from the lists of primary and secondary profiles when you set up your interfaces.

To use traffic flow filters

Purpose of the traffic flow filters

The purpose of the traffic flow filters is to assign different priorities to different types of traffic in order to optimize performance.

Example: When you are browsing the Internet a Standard IP connection is normally sufficient. However, to have a video conference you may need a Streaming IP connection in order to obtain a direct connection without interruptions. Your traffic flow filters can define these priorities, so that your connection is automatically set to Streaming e.g. when you have a video conference.

What are traffic flow filters?

When more than one type of traffic is needed, you must use both a primary and one or more secondary profiles. For the BGAN core network and the terminal to classify packets received from the external network into the proper profile, you need a traffic flow filter.

A list of traffic flow filters consists of one to eight packet filters. Each packet filter has an evaluation precedence index that is unique within all traffic flow filters associated with the profiles that share the same PDP (Packet Data Protocol) address. The evaluation precedence index determines the order in which the filters are applied; 0 is applied first, then 1 and so forth. Information of source, destination, type of service etc. is combined in each packet filter in the list.

To define traffic flow filters

To define the traffic flow filters, do as follows:

- From the left navigation pane, select **ADMINISTRATION > Traffic flow filters.**

Eval. Prec. Index	Profile	Source Address	Subnet Mask	Prot. No.	Dest. Port Range	Source Port Range	Type of Service	Type of Service Mask
0	Streaming 64			17		1024-5000		

[New entry](#) [Edit](#) [Delete](#)

- Click the link **New entry.**

ENTER VALUES FOR NEW FILTER

Eval. Prec. Index:

Profile:

Source Address:

Subnet Mask:

Prot. No.:

Dest. Port Range: To

Source Port Range: To

Type of Service:

Type of Service Mask:

- Select a number in the **Eval.Prec. Index** drop-down list.
The evaluation precedence index defines the order in which the traffic flow filters are applied to packets. 0 is first, then 1, 2 etc.

Note

This field is mandatory. Each filter must have a different Evaluation Precedence Index.

- Select the **Profile** from the drop-down list.
The available profiles are the profiles listed under ADMINISTRATION > Profiles.

5. Fill in one or more of the following fields to define the filter.
The allowed ranges appear in hover text when you pass the mouse over the fields.
 - **Source address + Subnet mask.**
This is an IPv4 IP address and subnet mask.
 - **Protocol number.**
This number is uniquely assigned for the protocol being used. TCP is set to 6, and UDP is set to 17. The protocol number determines which protocol is used by the traffic flow filter.
 - **Destination port range** (From and To).
 - **Source port range** (From and To). Note that you must fill in both From and To, even if there is only one port.
 - **Type of Service + Type of Service mask.**
Set this value to a number between 0 and 255.
Type of Service (TOS) is an 8-bit field in a packet header, with associated mask, that is used to define Quality of Service.

For further information on the principles and parameters of the traffic flow filters, refer to the 3GPP standards TS27.007 and TS 23.060.
6. Click **Apply** at the bottom of the page.

Example of a list of traffic flow filters

Below is an example of a list of traffic flow filters.

Eval. Prec. Index	Profile	Source Address	Subnet Mask	Prot. No.	Dest. Port Range	Source Port Range	Type of Service	Type of Service Mask
0	Streaming 64			17		2455 to 5000		Edit Delete
1	Standard			6		524 to 524		Edit Delete
New entry								

In this example, data packets are filtered in the following order:

1. The filter with evaluation precedence index 0 checks for UDP packets (protocol number 17), in the port range 2455-5000. When these packets are identified, they are assigned a 64 kbps Streaming channel (the Streaming 64 profile).
2. The filter with evaluation precedence index 1 checks remaining packets for TCP packets (protocol number 6), on port 524. These packets are routed to the standard IP connection (the Standard profile).
3. Remaining traffic is routed to the standard IP connection.

To set up the use of a SIM PIN in the terminal

To enable or disable the use of a SIM PIN

To enable or disable the use of a PIN to access the terminal, do as follows:

1. Select **ADMINISTRATION > SIM PIN**.

The screenshot shows a web interface for configuring SIM PIN settings. It is divided into two main sections: 'REQUIRE PIN' and 'CHANGE PIN'. In the 'REQUIRE PIN' section, there is a label 'Require PIN on startup' followed by two radio buttons: 'Enabled' (which is selected) and 'Disabled'. Below this is a text input field labeled 'PIN'. At the bottom of this section are two buttons: 'Apply' and 'Cancel'. A horizontal line separates this section from the 'CHANGE PIN' section. The 'CHANGE PIN' section contains three text input fields: 'Old PIN', 'New PIN', and 'Confirm new PIN'. At the bottom of this section are two buttons: 'Apply' and 'Cancel'.

2. Under **REQUIRE PIN** select **Enabled** or **Disabled**.
 - If you select **Disabled** you can access and use the terminal without a PIN.
 - If you select **Enabled** you must enter a PIN before you can change settings or make calls or data sessions.
3. Click **Apply**.

The new PIN settings will take effect at next power on.

To change the SIM PIN

To change the PIN used to access the terminal, do as follows:

1. Select **ADMINISTRATION > SIM PIN**.

REQUIRE PIN

Require PIN on startup Enabled Disabled

PIN

CHANGE PIN

Old PIN

New PIN

Confirm new PIN

2. Under **CHANGE PIN** type in the **Old PIN**.
 3. Type in the **New PIN** and retype it on the next line.
 4. Click **Apply**.
- The new PIN settings will take effect at next power on.

To set up user permissions

You can allow or deny users who are not administrators access to certain functions and make these pages read-only. This is useful if you want to protect the system against unintended changes. Study this screen thoroughly and decide to which areas of the system you want to give non-administrator users access. To set up the user permissions, do as follows:

1. From the left navigation pane, select **ADMINISTRATION > User permissions**.

ALLOW USERS TO:

Upload software	<input checked="" type="radio"/> Yes	<input type="radio"/> No
Edit phone book	<input checked="" type="radio"/> Yes	<input type="radio"/> No
Change phone settings	<input checked="" type="radio"/> Yes	<input type="radio"/> No
Change LAN settings	<input checked="" type="radio"/> Yes	<input type="radio"/> No
Change ISDN settings	<input checked="" type="radio"/> Yes	<input type="radio"/> No
Change IP handset settings	<input checked="" type="radio"/> Yes	<input type="radio"/> No
Change discrete I/O settings	<input checked="" type="radio"/> Yes	<input type="radio"/> No
Change supplementary services	<input checked="" type="radio"/> Yes	<input type="radio"/> No
Change common settings	<input checked="" type="radio"/> Yes	<input type="radio"/> No
Change general settings	<input checked="" type="radio"/> Yes	<input type="radio"/> No
Change tracking settings	<input checked="" type="radio"/> Yes	<input type="radio"/> No
Perform self test	<input checked="" type="radio"/> Yes	<input type="radio"/> No
Control connections from IP handset	<input checked="" type="radio"/> Yes	<input type="radio"/> No

ALLOW AT COMMANDS ON:

Changes to AT command permissions only take effect after reboot

LAN interface	<input checked="" type="radio"/> Yes	<input type="radio"/> No
---------------	--------------------------------------	--------------------------

2. For each item under **ALLOW USERS TO:**, select

- **yes** to allow access or
- **no** to block access to the settings.

Change general settings means change the selection of satellite and change the settings on the SETTINGS main page, that is enable/disable the L-Band interface.

Control connections from IP handsets means to start/stop data sessions using the main IP Handset from Cobham SATCOM (the handset with the number 0501).

3. At **ALLOW AT COMMANDS ON:**, select

- **yes** to allow the use of AT commands on the LAN interface, or
- **no** to block the use of AT commands on the LAN interface.

Note

This setting does not take effect until the terminal is restarted.

AT commands are low-level commands used to control modems, in this case the SAILOR FleetBroadband Terminal. They are typically used during service and maintenance or when troubleshooting the terminal.

4. Click **Apply**.

The settings to which access is denied are now greyed out for the non-administrator user.

Remote management

You can set up the terminal so that it can be controlled from a remote location, either using the web interface or AT commands.

To set up the terminal for remote management, do as follows:

1. From the left navigation pane, select **ADMINISTRATION > Remote management**.

REMOTE MANAGEMENT

Web server

Remote access Enabled Disabled

Incoming port

AT commands

Remote access Enabled Disabled

Incoming port

TRUSTED IP ADDRESSES

IP address

IP address

IP address

IP address

IP address

2. Select whether remote access should be **Enabled** or **Disabled** for the web server and/or for AT commands.
3. Type in the **Incoming port** numbers to use for the web server and for AT commands.

Note | The port number must be available at your service provider.

4. Under **TRUSTED IP ADDRESSES**, type in the IP addresses of the devices you want to give access to the terminal.
5. Click **Apply**.

If Static IP is included in your airtime subscription, we recommend using this static public IP address for the terminal in order to provide easy access to the terminal.

Note | You must activate a data connection in the terminal before you can access the terminal.

After preparing the terminal and activating the connection you can access the terminal from one of the trusted IP addresses, using the incoming port defined in the Incoming port field.

- For information on how to prepare the terminal for remote activation of a data connection, see the next section.
- For information on how to access the terminal, see *To access the terminal from a remote location* on page 69.
- For information on how to set up a static IP address, refer to step 7 on page 147 in the section *To edit a network user group*.

Remote activation

If you want to remotely control the terminal, it must have activated a connection. You can do this by sending an SMS to the terminal. The terminal must be powered up and logged on to the satellite services to receive the SMS and then start the connection. The SMS activation is always protected by a password. You can set up the terminal to send an SMS confirmation on the status of the connection, whether it is activated successfully or the activation failed.

Note

The terminal must be logged on to the satellite services to receive and accept an activation SMS. If the SMS is considered too old or sent before the terminal has been switched on and has logged on, the SMS will be ignored.

Important

This service is available if the service provider has an interoperability agreement with Inmarsat that allows for roaming. If in doubt, contact your service provider.

To set up the terminal for remote activation with SMS, do as follows:

1. From the left navigation pane, select **ADMINISTRATION > Remote activation**.

The screenshot shows a configuration page titled "REMOTE ACTIVATION". It contains the following elements:

- REMOTE ACTIVATION** (Section Header)
- Remote activation of data sessions Enabled Disabled
- Send confirmation Enabled Disabled
- Password
- TRUSTED NUMBERS** (Section Header)
- Number
- Number
- Number
- Number
- Number
- Apply Cancel

2. Select whether remote activation should be **Enabled** or **Disabled**.

3. Select whether confirmation by SMS should be **Enabled** or **Disabled**.
4. Enter the password. It can be up to 32 characters long. The characters 0-9, a-z and A-Z are allowed. The password is mandatory and must match the password in the activation SMS.
5. Enter at least one trusted mobile number from which the terminal accepts an activation SMS. If no numbers are entered the feature is disabled automatically. Use the wild card * to accept a range of trusted numbers.

Mobile number with wild card	Mobile numbers accepted
00453955880*	004539558800 to 004539558809
0045395588*	004539558800 to 004539558899

6. Click **Apply** to save the new settings.

For information on how to send an activation SMS, see *To activate a data connection with an SMS* on page 70.

Link monitoring

You can monitor the external IP connection of the SAILOR FleetBroadband system using the link monitoring feature. With this feature activated, the terminal will send out ping commands (ICMP Echo Requests) to a server of your choice.

Note Link monitoring is only performed on data connections with the Default network user group (see *To set up the network user groups* on page 144). This data connection must be activated before link monitoring can start.

To set up link monitoring, do as follows:

1. From the left navigation pane, select **ADMINISTRATION > Link monitoring**.

LINK MONITORING

Link monitoring Enabled Disabled

Interval Minutes

Retries

Primary IP address

Secondary IP address

2. Select **Enabled** if you want to enable Link monitoring.
3. Select the **Interval** between each ping.
4. Select the number of **Retries** before the terminal reboots.
5. Type in the **Primary** and optionally the **Secondary IP address**. This is the IP address of the server(s) to which the terminal will send ping commands.

Note Use a server that is reliable and that supports and responds to ICMP Echo Requests.

6. Click **Apply**.

When a data session is started with the Default network user group, the terminal will start sending ping commands to the Primary IP address the number of times specified at Retries. If no response is received, it will send the same number of ping commands to the Secondary IP address, if available. If no response is received here either, the terminal will reboot.

Restricted dialing

RESTRICTED DIALING

Restricted dialing Enabled Disabled

Allowed numbers or masks

Phonebook dialing

Limit outgoing calls to numbers in terminal phonebook Enabled Disabled

PHONE STATUS

0301 (Phone)	<input checked="" type="checkbox"/> Restrictions enabled
0302 (Phone)	<input checked="" type="checkbox"/> Restrictions enabled
0401 (ISDN)	<input checked="" type="checkbox"/> Restrictions enabled
0501 (IP handset)	<input checked="" type="checkbox"/> Restrictions enabled
0502 (IP handset)	<input checked="" type="checkbox"/> Restrictions enabled
0503 (IP handset)	<input checked="" type="checkbox"/> Restrictions enabled
0504 (IP handset)	<input checked="" type="checkbox"/> Restrictions enabled
0505 (IP handset)	<input checked="" type="checkbox"/> Restrictions enabled
0506 (IP handset)	<input checked="" type="checkbox"/> Restrictions enabled

In order to manage the use of the system efficiently you can set up the terminal to limit all calls to allowed numbers or numbers in the phone book.

This feature can be enabled for each connected handset separately. Each handset has its own local number.

To set up the terminal for restricted dialing, do as follows:

1. From the left navigation pane, select **ADMINISTRATION > Restricted dialing**.
2. Select whether restricted dialing should be **Enabled** or **Disabled**.
3. Type in the allowed numbers or masks in the entry fields.
The numbers or masks must be max. 32 digits and may start with +. No other special characters are allowed. A mask is the first part of a phone number, and it covers all numbers that start with that first part. See the example below.

Mask	Numbers accepted
00453955880	004539558800 to 004539558809
+45395588	004539558800 to 004539558899

4. Select whether outgoing calls should be limited to the numbers in the terminal phone book (Enabled) or not (Disabled).
5. Check which local numbers are available in your system. Then select for which local numbers you want to enable the restriction.
6. Click **Apply** to apply the new settings.

Multi-voice

If you wish to have more simultaneous voice calls, you can add Multi-voice to your airtime subscription. When Multi-voice is enabled in your terminal, you can have up to 9 simultaneous calls using IP Handsets (max. 6 for SAILOR 250 FleetBroadband).

Enabling Multi-voice

Note You must have Multi-voice in your airtime subscription and the software version of the IP Handsets must be at least version 1.13, in order to support the Multi-voice function.

To enable Multi-voice in your SAILOR FleetBroadband system, do as follows:

1. From the left navigation pane, select **ADMINISTRATION > Multi-voice**.

MULTI-VOICE

Multi-voice Disabled
 Multi-voice
 Using external Multi-voice PBX

Multi-voice PBX connected to

Use additional numbers Yes
 No

APN

2. To use the SAILOR FleetBroadband Terminal for Multi-voice, select **Multi-voice**.

If you want to use an external PBX, select **Using external Multi-voice PBX** and select the interface used to connect the PBX to the terminal

(for SAILOR 250 FleetBroadband only Phone/Fax can be selected). See the manufacturer documentation for your Multi-voice PBX.

3. If you want to assign additional numbers, select **Use additional numbers**.

Note

You must have additional numbers in your subscription and enter the additional numbers under **PHONE BOOK > Mobile numbers**. Then you can use the setup page for your handset interface to assign the additional numbers to the handsets you want to be able to call directly. See *Handset contexts with additional numbers* on page 59.

4. The VoIP APN used for Multi-voice automatically appears in the APN field. You can type in another APN if necessary. You find the Multi-voice APN name in your subscription documentation.
5. Click **Apply**.

Voice Distress

Note

You must have Voice Distress in your airtime subscription and the software version of the IP Handset used for Distress must be at least version 1.12, in order to support the Voice Distress function.

Important

To make sure the Distress IP handset always keeps the same handset number, we recommend clearing the setting **Settings > Start up options > Auto BGAN SIP** in the menu system of the IP Handset used for Voice Distress, and assigning the number and password manually. See the user manual for the IP Handset and *To connect and configure IP handsets* on page 128.

To set up the terminal for Voice Distress, do as follows:

1. Connect your Voice Distress system as described in the manual for the Voice Distress system.

- From the left navigation pane, select **ADMINISTRATION > Voice Distress settings**.

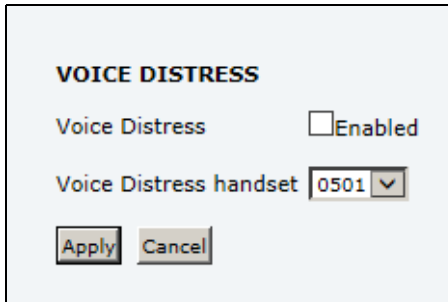

VOICE DISTRESS

Voice Distress Enabled

Voice Distress handset 0501 ▼

Apply Cancel

- Select the IP handset number that you are using for Voice Distress.
- Select **Enabled** and click **Apply**.
- Reset the terminal.

To check that the system is configured correctly, look at the Distress IP Handset and the Alarm Panel.

- the Distress IP Handset display should show  (designated for Distress), and
- the Alarm panel should show **FB ●** (connected to a FleetBroadband terminal).

NSD mode

If you have an Inmarsat GX system together with your SAILOR FleetBroadband system and you want to use the SAILOR FleetBroadband as backup when the GX service is not available, you can acquire a Network Service Device from Inmarsat. The NSD will use a PPPoE connection to allow your system to use the BGAN service when your system is out of GX spot beam coverage. To enable NSD, do as follows:

1. Install the NSD according to the guidelines from your supplier.
2. From the left navigation pane in the web interface, select **NSD mode**.

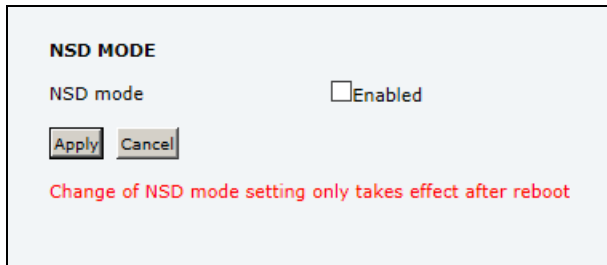

3. Select **Enabled** and click **Apply** if you want to use an NSD with your SAILOR FleetBroadband system.

Dual antenna

When your SAILOR 500 FleetBroadband antenna cannot obtain full line of sight to the satellite, e.g. because of blocking objects on board the ship, you can use a dual antenna solution. The purpose of the dual antenna solution is to obtain full line of sight with a combination of two SAILOR 500 FleetBroadband systems and a Dual Antenna Control Unit.

For details on how to install and set up the system, see the manual for SAILOR 500 FleetBroadband Dual Antenna Solution.

Antenna RF noise filter

The SAILOR FleetBroadband system has a built-in filter that makes it resilient to interference from terrestrial mobile systems that operate inside the Inmarsat band and that may be located near the coast.

Note We recommend leaving this setting as is (Auto). By default, the filter is automatically activated when the SAILOR FleetBroadband system is subjected to interference.

To set up the Antenna RF noise filter, do as follows:

1. From the left navigation pane, select **ADMINISTRATION > Antenna RF noise filter**.

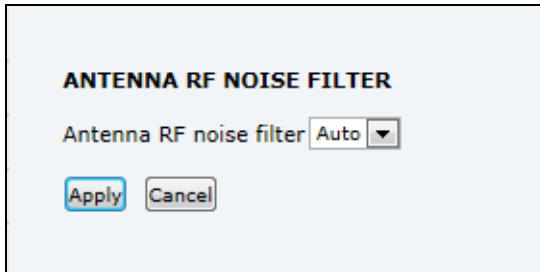

2. Select **Auto**, **On** or **Off**.
 - **Auto**. The filter is automatically activated when the SAILOR FleetBroadband is subjected to interference from terrestrial mobile systems.
 - **On**. The filter is always active.
 - **Off**. The filter is never active.
3. Click **Apply**.

Note The L-Band interface is disconnected when the Antenna RF noise filter is active.

Positioning system

Note | This feature is only available if the GNSS module is installed in your terminal. If in doubt, ask your distributor.

The SAILOR FleetBroadband uses the GPS positioning system by default, but you can select between **GPS**, **Beidou**, **GPS and Beidou**, and **GPS and GLONASS**.

1. From the left navigation pane, select **ADMINISTRATION > Positioning system**.

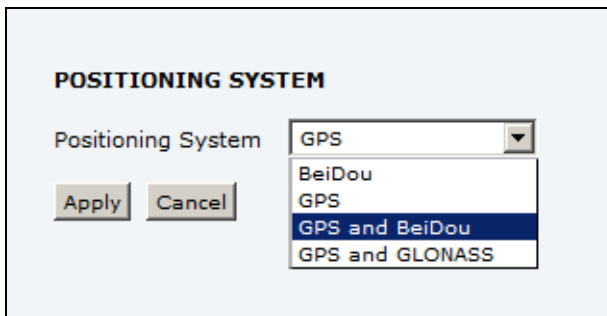

2. From the drop-down list, select the positioning system(s) you want to use.
3. Click **Apply**.

Note | If you move outside coverage of the selected system, you will eventually lose connection to the satellite network. The Position field in the Dashboard of the web interface will show "Acquiring".

Help desk and diagnostic report

To access the Help desk

If you need help **with airtime-related issues** you may call the Help desk. By default, the Help desk is the phone number for your Airtime Provider, if it is available on the SIM card.

To access the Help desk, select **HELP DESK** from the left navigation pane.

The screenshot displays the web interface's Help Desk section. On the left, a navigation menu lists various system functions, with 'HELPDESK' selected and expanded to show sub-options: 'Event list', 'Event log', 'Extended status', and 'Self test'. The main content area is titled 'SUPPORT:' and contains the text 'For help, please contact:' followed by a blue hyperlink 'Please enter support information here'. Below this, there is a prompt 'Generate diagnostic report to file?' and a grey button labeled 'Generate report'.

If the Help desk number is available on the SIM card, the number is displayed as a link. To change the number, click the link, change the number and click **Apply**.

If you need help **with terminal- or antenna-related issues** call your local distributor.

To generate a diagnostic report

The diagnostic report contains relevant information for troubleshooting. When you contact your distributor for support, please enclose this file.

To generate a diagnostic report, do as follows:

1. Click **Generate report** from the **HELP DESK** page.
In some browsers the file may open directly in your browser.

Note

It normally takes about 1 minute, sometimes longer, to generate the report. The report may open in your browser while being generated. Wait until the report is finished before saving the file.

To save the file, select **File > Save As** in your browser.

2. Choose a location for the file and save it.

Event logging and self test

To view the Event list or the Event log

Overview

When an event is registered, the web interface shows an event icon in the icon bar as long as the event is active.



The **Event list** only shows events that are currently active, whereas the **Event log** shows the history of events that have occurred.

Event list

To view the event list, click the event icon from the icon bar at the top of the web interface, or select **HELPDESK > Event list** from the left navigation pane.

First reported	ID	Unit	Severity	Text
12:10:17 7 Jun 2017	08048-0	Terminal	WARNING	All PoE ports except port 1 are shut down due to high temperature
12:10:17 7 Jun 2017	01120-0	Terminal	WARNING	Too high temperature warning

The Event list page shows a detailed list of active events including the time of the first occurrence, ID and severity of the event message, and a short text that describes the error. For more information on the event messages, refer to *Event messages* on page 217.

Event log

The **Event log** shows the same information as the Event list, but also includes events that occurred in the past and are no longer active. Additionally, it lists events of informational character that describe normal phases of operation for the terminal.

To view the Event log, select **HELPDESK > Event log** from the left navigation pane.

Self test

The Self test performs system test on the SAILOR FleetBroadband System, similar to the tests that are performed during the Power On Self Test (POST).

Important

The terminal will reboot when performing the self test. All ongoing calls or data sessions will be terminated.

To activate a Self test, do as follows:

1. Select **HELPDESK > Self test**.

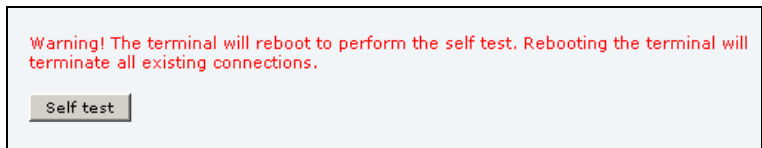

2. Click **Self test**.
3. Click **OK** in the Warning dialog.
The terminal now reboots and performs a self test.

Extended status

To see the Extended status page, select **HELPDESK > Extended status**.

To view updated information on the **Extended status page**, click **Refresh**.

The Extended Status page shows the following information:

- The antenna Product ID (TT-number. Refer to the section *System units* on page 204).
- The status of the connection to the air interface (IAI-2). This field should normally show “Registered”, unless the system is still in the startup process.
- Ongoing data sessions (IP address) and connection status, e.g. Active or Suspended.
- Ongoing calls and their connection status.

Site map

The web interface also offers a site map page. Use this page to get an overview of the submenus.

To access the site map, select **SITE MAP** from the left navigation pane.

Click on items in the site map to go directly to the relevant location.

Troubleshooting

This chapter gives guidelines for troubleshooting and provides an overview of the different means of status signalling. It has the following sections:

- *To get support*
- *To upload software using the web interface*
- *To upload software using the TMA*
- *Part numbers*
- *Troubleshooting guide*
- *Status signalling*
- *Logging of events*
- *Reset button*
- *List of reserved IP subnets*
- *Supported AT commands for PPPoE*

To get support

Contact information

Should your Cobham SATCOM product fail, please contact your dealer or installer, or the nearest Cobham SATCOM partner. You will find the partner details on www.cobham.com/satcom, **Technical Service Partner List**. You can also access the Partner Portal at www.cobham.com/satcom, **Cobham SYNC Partner Portal**, which may help you solve the problem. Your dealer, installer or Cobham SATCOM partner will assist you whether the need is user training, technical support, arranging on-site repair or sending the product for repair. Your dealer, installer or Cobham SATCOM partner will also take care of any warranty issue.

To upload software using the web interface

To view software version status

To view the version of the embedded software in the terminal, do as follows:

1. Connect a computer.
2. Enter the web interface and see the **Software version** field in the **Dashboard**.

To upload software using the web interface

You can upload software using the web interface. If you have an administrator user name and password you do not need to insert a SIM card nor to enter the PIN to be able to upload software. For further information, see *To upload software* on page 158.

To upload software using the TMA

To install the TMA

Note

The TMA (ThraneLINK Management Application) must be at least version 1.02 in order to work with BGAN.

PC requirements

- Standard PC with Windows 7, 8, 10, Vista or XP, and Ethernet connection.
- Make sure that you have administrator rights for the PC.

Installation

To install the TMA, do as follows:

1. Go to www.cobham.com/satcom.

2. Select **Cobham SYNC Partner Portal**.
3. Select **Downloads > Product software > Maritime**.
4. Locate the **ThraneLINK Management Application** software package and download it to your PC.
5. Extract the files from the zip file.
6. Click **setup.exe** to start the installation wizard.
On Windows Vista/7/8/10, when prompted, select **Yes** to allow the installation to make changes to the computer.
7. Follow the instructions in the wizard.

When the wizard is complete an icon appears on your PC desktop. You can also find the TMA under Programs > Thrane > TMA.



If you have problems with your Firewall settings, please refer to the TMA quick guide, available on the **Cobham SYNC Partner Portal** under **Downloads > Manuals > Maritime**.

To update software with the TMA

To update software in a ThraneLINK product, do as follows:

1. Connect the PC to the LAN with the ThraneLINK products for which you want to update software.
2. Click the TMA icon on the PC's desktop. The program starts and displays the ThraneLINK products found on the network.
If a Windows Security Alert pops up click **Allow access** (Windows 7) or **Unblock** (Windows XP).
3. Insert a USB memory stick with the new software version (placed in the root) into a USB connector in the PC. ¹

-
1. If the new software is not automatically found, you can point to the location of the software. Select the tool icon in the **Software update** page, select **Search for software** and enter the location of the software.



The TMA automatically discovers the new software version(s) and a software update icon flashes next to the unit(s) for which the software can be installed.



4. From the main page of the TMA, select the product you want to update.
5. Select **Software update** at the bottom of the product page.



Check that the new software version is correct.

6. Select **Update**.

The progress of the software update is shown in percent under the product icon. When installation is completed, a check mark appears instead.

Part numbers

System units

TT-3740A SAILOR 500 FleetBroadband system

Item	Part number
SAILOR 500 FleetBroadband antenna	403052A/B/C
SAILOR FleetBroadband terminal or SAILOR FleetBroadband 19" Rack Terminal	403738A or 403738A-T19

TT-3742A SAILOR 250 FleetBroadband System

Item	Part number
SAILOR 250 FleetBroadband Antenna	403050A
SAILOR FleetBroadband Terminal or SAILOR FleetBroadband 19" Rack Terminal	403738A or 403738A-T19

TT-3670A IP Handset & Cradle, wired

Item	Part number
IP Handset, wired	403672A
IP Cradle, wired	403674A

Troubleshooting guide

The below table provides information on some of the problems that might occur, including possible causes and remedies to solve the problems.

Problem	Possible Cause	Remedy
No signal or weak signal from the BGAN satellite.	The view to the satellite is blocked.	Make sure the antenna has a clear view in all directions. See the installation manual for details.
	The antenna cable is not properly connected.	Check that both ends of the cable are connected properly according to the guidelines in the Installation manual. Also check that no connectors are damaged.
	The system is set up to use one specific satellite, but the system is outside coverage from that satellite.	Enter the web interface. Select SETTINGS > Satellite selection . Select Auto and click Apply . The system will now search for the satellite with the strongest signal and attempt to connect.
No transmission on the BGAN network is possible.	The Radio silence function is activated from an external device connected to the I/O interface of the terminal.	If the Radio silence function should not be activated, deactivate it from the external device.
Connection to the Internet cannot be established.	Your network user group does not allow Internet access.	The administrator can access and change network user groups in the built-in web interface of the terminal.
256 kbps Streaming does not work	The elevation angle to the satellite is too low.	Availability of 256 kbps Streaming can only be guaranteed in areas with high elevation.

Problem	Possible Cause	Remedy
128 kbps Streaming does not work on SAILOR 250 FleetBroadband	The elevation angle to the satellite is too low.	Availability of 128 kbps Streaming on SAILOR 250 FleetBroadband can only be guaranteed in areas with high elevation.
The web interface cannot be accessed.	The browser is configured to use a proxy server.	For Microsoft Internet Explorer, select Tools > Internet Options > Connections > LAN Settings and uncheck Use a proxy server for your LAN .
	You have entered a wrong IP address.	Check the IP address and re-enter it. If you do not have the correct IP address, you can set the IP address temporarily to the default address (192.168.0.1) by pressing the Reset button. See <i>Function of the Reset button</i> on page 236.
	You are connected using VPN	Close down your VPN connection.
Multi-voice: Voice call is not put through	The mobile number is not correctly typed into the web interface.	Check that all mobile numbers from your airtime subscription are correctly typed into the web interface. See <i>To view and edit the mobile numbers</i> on page 91.
	Another call is already active and you are not using a handset connected to the LAN interface.	Use a handset connected to the LAN interface or wait until no other call is active.
	Not enough bandwidth	If possible, close down other voice and data connections and try again.

Problem	Possible Cause	Remedy
<p>A Phone/Fax connection cannot be established.</p>	<p>The cable is not properly connected</p>	<p>Connect the cable.</p>
	<p>The cable type or connector type is not correct.</p>	<p>For information on the correct type of connector and cable, refer to the installation manual.</p>
	<p>Incoming calls: The call type used for the call is not selected in the web interface.</p>	<p>Make sure the call type used for calls to the terminal is selected in the web interface. Access the web interface and select SETTINGS > Phone/Fax. Then, for each of the two ports, select the call type for incoming calls.</p>
	<p>SAILOR 250 FleetBroadband: If you are located in a low elevation area, < 20°, 3.1 kHz Audio is not supported.</p>	<p>Use Standard Voice instead of 3.1 kHz Audio when you are located in areas with < 20° elevation. Refer to <i>Service limitations</i> on page 16.</p>
	<p>A call is already active in the terminal.</p>	<p>If your system is using Multi-voice you can use an IP handset to make the call instead. Otherwise you must wait until the other active call is terminated.</p>

Problem	Possible Cause	Remedy
An ISDN connection cannot be established	The cable is not properly connected.	Connect the cable.
	You have connected to the LAN interface.	Connect the cable to the interface marked ISDN.
	The cable type or connector type is not correct.	For information on the correct type of connector and cable, refer to the installation manual.
	Incoming phone calls: The call type used for the call is not selected in the web interface.	Make sure the call type used for calls to the terminal is selected in the web interface. Access the web interface and select SETTINGS > ISDN . Then select the call type for incoming calls.
	SAILOR 250 FleetBroadband: The ISDN service is not supported.	Use another service. You may still use the ISDN interface on the terminal, but only Standard Voice and 3.1 kHz Audio are available.
	A call is already active in the terminal	Wait until the other active call is terminated, then try again.

Problem	Possible Cause	Remedy
No phones are ringing on incoming calls	The Mute function is activated from an external device connected to the I/O interface of the terminal.	If the Mute function should not be activated, deactivate it from the external device.
	The call types for the handset interfaces are not set up correctly.	Check the call types for your handset interfaces. See <i>To select the call type</i> on page 43.
	If you have Multi-voice, see the following entry in this table: <i>Multi-voice: Voice call is not put through.</i>	See the following entry in this table: <i>Multi-voice: Voice call is not put through.</i>

Problem	Possible Cause	Remedy
A LAN connection cannot be established.	The cable is not properly connected.	Connect the cable.
	The cable type or connector type is not correct.	For information on the correct type of connector and cable, refer to the installation manual.
	<p>The connected equipment is set up to use a static IP address and</p> <ol style="list-style-type: none"> 1. the IP address is reserved for internal use in the terminal, or 2. the terminal is set up to assign a dynamic IP address to the equipment. 	<p>Do one of the following:</p> <ol style="list-style-type: none"> 1. Change the IP address of the connected equipment to an IP address that is not reserved. See <i>List of reserved IP subnets</i> on page 237. 2. Set up the equipment to use a dynamic IP address, or disable DHCP in the terminal. See step 2 in the section <i>To set up the local LAN IP addresses</i> on page 105.

Problem	Possible Cause	Remedy
<p>An IP handset connection cannot be established.</p>	<p>The cable is not properly connected.</p>	<p>Connect the cable.</p>
	<p>You have connected to the ISDN interface.</p>	<p>Remove the cable and connect to one of the LAN connectors instead.</p>
	<p>There is no power (PoE) in the LAN interface. The reason may be that there is not enough power to supply PoE for the LAN interface.</p>	<p>Check that the input voltage is within the specified range (10.5 - 32 V DC; 14 A - 5.5 A).</p> <p>Check that you do not have too many power-consuming devices connected. The maximum available output power on the LAN (PoE) interface is 32 W if you are using a 12 V supply and 64 W if you are using a 24 V supply.</p> <p>If possible, disconnect other connected devices.</p>
	<p>If you have Multi-voice, see the following entry in this table: <i>Multi-voice: Voice call is not put through.</i></p>	<p>See the following entry in this table: <i>Multi-voice: Voice call is not put through.</i></p>
<p>The administrator password does not work.</p>	<p>Someone has changed the administrator password.</p>	<p>If the correct password is not found, you have to reset the password.</p> <p>Contact your supplier for a reset code. You must provide the serial number and IMEI number of the terminal.</p> <p>Then enter the web interface and reset the password as described in: <i>To reset the administrator password on page 165.</i></p>

Status signalling

Overview

There are many ways of troubleshooting if an error occurs. The terminal has different means of status signalling, to help you find the cause of a problem:

- **Indicators.**
- **Event messages.**
- **Event log.**

Indicators, event messages and logs are described in the following sections.

Light indicators

Overview

The terminal has a number of LEDs, placed in the panel at the top of the terminal:

- a green Power indicator,
- a green/red/orange Terminal indicator,
- a green/red/orange Antenna indicator,
- a green Message indicator and
- 3 LAN indicators for each LAN interface, showing Activity (Green), Link/Speed (Green/Yellow) and PoE (Green/Red).

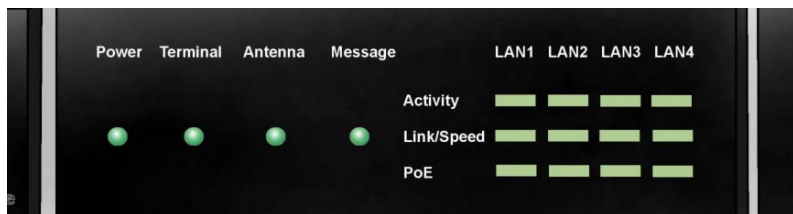

General status indicator functions

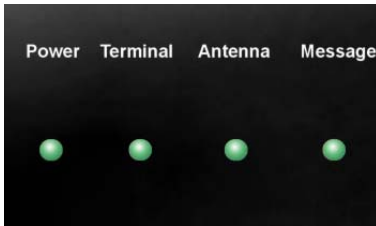

Power indicator

Behavior	Meaning
Green	Power OK.
Flashing green	The terminal is powering up.
Flashing orange	The terminal is closing down.
Off	No power.

Terminal indicator

Behavior	Meaning
Steady green	Ready. BGAN registration completed.
Flashing green	Please wait - process in progress. BGAN registration ongoing.
Orange	Warning - temporary malfunction. User action is required.
Red	Critical error. Check the event log. If the problem is in the SAILOR FleetBroadband system and you cannot solve it, contact your distributor and return the unit for repair.

Antenna indicator

Behavior	Meaning
Steady green	Tracking. The antenna is ready for use.
Flashing green	Please wait - process in progress. Slow flashing: The antenna is starting up Rapid flashing: Sky scan
Orange	Warning - temporary malfunction. User action is required.
Red	Critical error. Check the event log. If the problem is in the SAILOR FleetBroadband system and you cannot solve it, contact your distributor and return the unit for repair.

Message indicator

Behavior	Meaning
Flashing green	A new SMS message has arrived.
Off	No new messages, or the unit is off.

LAN indicator functions



Activity indicator

Behavior	Meaning
Flashing green	The LAN port is active.

Link/Speed indicator

Behavior	Meaning
Green	Link speed is 100 Mbps.
Yellow	Link speed is 10 Mbps.
Off	The link is down.

PoE indicator

Behavior	Meaning
Green	The terminal is supplying power to the LAN port.
Red	The connected device requires more power than the terminal can supply to the LAN port.
Off	The terminal is not supplying power to the port.

Event messages

Display of event messages

The terminal can detect events during POST (Power On Self Test) or CM (Continuous Monitoring). When the terminal detects an event that requires your action, it issues an event message.

When your terminal issues an event message, the Terminal indicator or the Antenna indicator in the LED panel on top of the terminal signals the event, according to the tables *Terminal indicator* and *Antenna indicator* in the previous section.

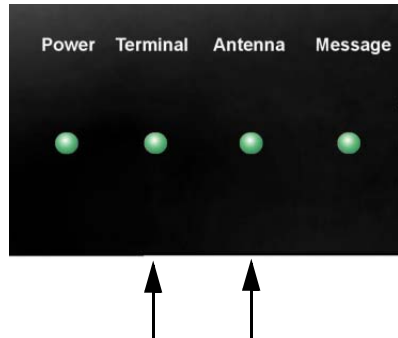

You can see the active event messages in the web interface by clicking the warning symbol in the icon bar at the top in the web interface. You can also see the messages in the IP Handset from Cobham SATCOM.

All events are logged in the event log. For information on the event log, see *To view the Event list or the Event log* on page 198.

List of events

The following list explains most of the events that may show in the web interface of the terminal. Note that the list is not complete.

Note Events with “Info” level are not included in this list. Only events that can appear in the alarm list and cause a warning icon  in the web interface are included.

ID	Event Text	Explanation	Remedy
00100to 00199	System data damaged	Important system data is damaged	Do not use the terminal. Contact your distributor.
00210to 00219	SIM module error	The SIM interface on the terminal cannot be used.	Contact your distributor.
00240to 00249	Temperature sensor error	The terminal is in danger of overheating.	Do not use the terminal. Contact your distributor.
00260to 00269	System error	The terminal cannot communicate on the satellite network.	Contact your distributor.
00270to 00279	Voice module error	Voice services cannot be accessed by the terminal	Contact your distributor.
00280to 00289	Ethernet module error	The Ethernet interface on the terminal cannot be used.	Contact your distributor.

ID	Event Text	Explanation	Remedy
00300to 00309	GPS module error	The GNSS module is out of function. The terminal cannot obtain a valid position.	Contact your distributor.
00330to 00339	ISDN failure	The ISDN interface on the terminal cannot be used.	Contact your distributor.
00340to 00349	2-wire failure	The Phone/Fax interface of the terminal cannot be used.	Contact your distributor.
00350to 00359	AD9864 calibration data error	Internal error in the receiving part of the terminal.	Contact your distributor if the problem persists.
00360to 00369	No antenna found	The terminal cannot communicate with the antenna.	<ol style="list-style-type: none"> 1. Check antenna cable between terminal and antenna. 2. Reboot the terminal.
01010to 01019	Temperature too low (critical)	Low ambient temperature is causing the performance of the terminal to be degraded or halted.	<p>Move the terminal to a warmer location.</p> <p>For information on ambient temperature limits, see the installation manual.</p>

ID	Event Text	Explanation	Remedy
01020 to 01029	Too low temperature warning	<p>Low ambient temperature is causing the performance of the terminal to be degraded or halted.</p> <p>The terminal will assume radio silence if the problem is in the ACM module of the antenna.</p>	<p>Move the terminal to a warmer location.</p> <p>For information on ambient temperature limits, see the installation manual.</p>
01110 to 01119	Temperature too high (critical)	<p>Terminal: Critically high temperature is causing the terminal to shut down.</p> <p>Antenna: Critically high temperature is causing the antenna to stop transmission.</p>	<p>If possible, move the failing unit to a cooler location.</p> <p>For information on ambient temperature limits, see the installation manual.</p> <p>Contact your distributor if the problem persists.</p>

ID	Event Text	Explanation	Remedy
01120to 01129	Too high temperature warning	<p>High ambient temperature is causing the performance of the system to be degraded or halted.</p> <p>If the problem is in the terminal: All PoE ports are shut down, except port 1 and the bit rate for Standard data is reduced.</p> <p>If the problem is in the antenna: The bit rate is reduced.</p>	<p>Move the terminal to a cooler location.</p> <p>For information on ambient temperature limits, see the installation manual.</p>
01300to 01309	No GPS fix	The GNSS receiver has not yet achieved position fix.	<p>Make sure the view to the GNSS satellites is not blocked.</p> <p>Note that in some cases it may take up to 10 minutes to obtain position fix.</p>
01400to 01409	Satellite signal lost	The SAILOR system no longer receives a signal from the satellite.	Make sure the antenna has a clear view to the satellite.

ID	Event Text	Explanation	Remedy
01500to 01509	SIM card missing	No SIM card is detected in the SIM slot.	Insert SIM card. If the SIM card is already inserted, try removing and reinserting it.
01600to 01609	SOS calls only	The SIM card is not accepted by the network. Only emergency calls are allowed.	Enter the PIN and wait for network approval. If the problem persists, contact your Airtime Provider.
01700to 01709	Registration for voice failed	The SAILOR system has not yet been allowed to register for voice services (Circuit Switched).	If the problem persists, contact your Airtime Provider.
01800to 01809	Registration for data failed	The SAILOR system has not yet been allowed to register for data services (Packet Switched).	If the problem persists, contact your Airtime Provider.
02000to 02009	Satellite signal weak	The signal from the satellite is weak.	Check the line of sight to the satellite. Check in the web interface under SETTINGS > Satellite selection that you have selected Auto , or a satellite covering your current position.

ID	Event Text	Explanation	Remedy
02100to 02109	Ciphering Off	The network has turned ciphering off.	Do not transmit data that requires ciphering.
02200to 02209	Ethernet data session failed	Ethernet data session could not be established.	See the call log for the cause of the error. Refer to <i>To view the lists of calls and data sessions</i> on page 95. If the problem persists, contact your distributor.
02900to 02909	Network failed authentication	The SAILOR system does not accept the network as a valid BGAN network.	Restart the SAILOR system. If the problem persists, contact your distributor.
03500to 03509	2-wire calibration failure	2-wire calibration failed on the Phone/Fax interface, because of: 1. Common mode balance error. 2. The phone is off hook. 3. Wires are shorted to each other or shorted to ground.	1. Check the wires to your phone or fax. 2. Put the phone on hook. 3. Check the wires.

ID	Event Text	Explanation	Remedy
03600 to 03609	2-wire operational failure	<p>The Phone/Fax interface fails to operate, for one of the following reasons:</p> <ol style="list-style-type: none"> 1. Ground shorted. 2. Power overload. 3. Temperature overload. 	<ol style="list-style-type: none"> 1. Check the wires. 2. Wait until the event is cleared; then try again. 3. Wait until the event is cleared; then try again.
08002	One or more ports has PoE disabled due to power limitations	The power supply to the terminal has dropped critically. PoE is disabled to ensure enough power to the antenna.	Ensure a stable power supply to the terminal.
08008	Antenna exceeds voltage threshold	The antenna voltage is either too high or too low.	<p>Check the cable to the antenna.</p> <p>Contact your distributor if the problem persists.</p>
08009	Power Hold-up - the terminal can no longer power the antenna	The power supply to the terminal has dropped for too long. The antenna does not have enough power to function.	Ensure a stable power supply to the terminal.

ID	Event Text	Explanation	Remedy
0800A	Reduce PoE - the terminal reduces PoE with 30W	The input voltage to the terminal is too low. The terminal will lower PoE power from 60 W to 30 W.	Ensure a stable power supply to the terminal.
0800B	PoE Overvoltage protection is activated	Overvoltage is detected in the terminal. The terminal will be shut down in 10 minutes.	Do not use the terminal. Contact your distributor.
0800D	Antenna Overvoltage protection is activated	Overvoltage is detected in the antenna. The terminal will be shut down in 10 minutes.	Do not use the terminal. Contact your distributor.
08010	Undervoltage has been detected	The input voltage has dropped below an acceptable level. The terminal will be shut down in 10 seconds if the situation persists.	Ensure a stable power supply to the terminal.
0801B	Lost connection to the GPS receiver	Communication with the GNSS receiver in the antenna is lost.	Contact your distributor if the warning persists.
0801D	Uploading firmware to antenna	New firmware is being uploaded to the antenna. The Event will be cleared when upload has finished.	Contact your distributor if the Event is not cleared within 5 minutes.

ID	Event Text	Explanation	Remedy
0802C	Firmware update still fails after several retries	The terminal was unable to upload new firmware to the antenna.	Contact your distributor.
0802D	Firmware update failed	The terminal was unable to upload new firmware to the antenna.	Reboot the terminal. Contact your distributor if the problem persists.
0802E	Firmware is older than current antenna version	The firmware in the antenna is newer than expected by the terminal.	Update the terminal software.
0802F	Antenna main image could not be loaded	Antenna failed to start up normally.	Reboot the terminal. Contact your distributor if the problem persists.
08030	Antenna could not enter main application mode	Antenna failed to start up normally.	Reboot the terminal. Contact your distributor if the problem persists.
08031	Failed to enter normal operation	Antenna failed to start up normally.	Reboot the terminal. Contact your distributor if the problem persists.
08032	Firmware image version lower than active antenna version	The firmware in the antenna is newer than expected by the terminal.	Update the terminal software.

ID	Event Text	Explanation	Remedy
08033	Firmware image doesn't support antenna hardware	The antenna hardware version is not supported by the terminal.	Contact your distributor.
08034	Antenna failed to exit Flash Manager. Power cycle needed	New firmware was successfully uploaded to the antenna but the antenna failed to start normally with the new firmware.	Reboot the terminal. Contact your distributor if the problem persists.
08035	Unable to open port for HPA burst monitoring	There was an error communicating with the antenna.	Reboot the terminal. Contact your distributor if the problem persists.
08036	Radio silence is activated	The Radio silence function is activated. No transmission is allowed.	If the Radio silence function should not be active, enter the web interface and select SETTINGS > Discrete I/O . Then uncheck the Enabled box for Radio silence .
08040	Excessive writes to the flash memory	Wrong APN name or username/ password for a profile which is set to auto-activate.	Check that the APN name, username and password are set up correctly for your profiles.

ID	Event Text	Explanation	Remedy
08045	Antenna - Startup temperature too low	The temperature in the antenna is too low for the system to start up	None. If the ambient temperature is outside the specified limits, the antenna may not be able to start up properly. Refer to the installation manual for temperature specifications.
08046	Timeout of startup sequence - No antenna or antenna temperature too low	<p>The start-up sequence of the terminal has timed out because:</p> <ul style="list-style-type: none"> • the antenna is not properly connected, or • the antenna temperature is too low to start up. 	Check that the antenna cable is properly connected at both ends.
08048	All PoE ports except port 1 are shut down due to high temperature	The temperature in the terminal is too high. All PoE ports except port 1 are shut down to reduce the temperature.	Move the terminal to a cooler location, or avoid using PoE on port 2-4.

ID	Event Text	Explanation	Remedy
08049	Data rate reduction due to high temperature	The bit rate of the data channel is reduced because the temperature is too high.	Move the terminal to a cooler location
0804B	Illegal combination of antenna and terminal	You are not using the right combination of antenna and terminal.	Only use the antenna(s) intended for use with your terminal.
0804C	The chosen satellite is not visible at current GPS position	The terminal is set up to use a satellite that is not visible at the current GNSS position.	<p>Enter the web interface and select SETTINGS > Satellite selection.</p> <p>Then select Auto to let the terminal automatically find the satellite with the best signal, or select a satellite visible from your current position.</p>
0804D	Antenna firmware image is missing in terminal	The software is corrupt	Upload new software to the terminal. Refer to <i>To upload software</i> on page 158.

ID	Event Text	Explanation	Remedy
08054	Transmission aborted due to extreme temperature	The system stops all transmission due to: <ul style="list-style-type: none"> • critically high temperature in the HPA or ACM module of the antenna, or • too low temperature in the ACM module. 	None. The system must operate within the allowed temperature range to work properly. For information on ambient temperature limits, see the installation manual.
08056	USIM rejected	The type of USIM card inserted in the terminal is not correct for your terminal.	Make sure you have the correct type of USIM card. For example, an USIM card for a land-mobile system will not work for a maritime system and vice versa.
08062	No connection to network. Voice Distress unavailable.	The FleetBroadband terminal has lost contact with the satellite.	Wait until the system is registered on the network again.

ID	Event Text	Explanation	Remedy
08063	No connection to Voice Distress handset	<p>The system is configured for Voice Distress but there is no connection between the terminal and the Distress IP handset.</p> <p>or</p> <p>The software in the IP Handset is older than version 1.12</p>	<p>Check: Distress IP handset connected correctly to the LAN (PoE) interface.</p> <p>Local number and password, see <i>To connect and configure IP handsets</i> on page 128.</p> <p>Correct local number selected in Voice Distress page in web interface.</p> <p>SW version in IP Handset is 1.12 or newer.</p>
08064	No connection to FleetBroadband Alarm Panel	The system is configured for Voice Distress but there is no connection between the terminal and the SAILOR 3771 Alarm Panel	Check that the alarm panel is connected correctly to the terminal. See the installation manual for the Voice Distress (Non-SOLAS) system.
08065	Voice Distress Supplementary Service (eMLPP) subscription failure	Voice Distress registration fails. The service has not been enabled on your SIM card.	Contact your service provider and request that Voice Distress is enabled in your SIM card.

ID	Event Text	Explanation	Remedy
08066	Voice Distress Supplementary Service (Call Waiting) subscription failure	The FleetBroadband terminal is not able to activate the Call Waiting service in the network.	Check with your service provider that the Call Waiting service is commissioned.
0806E	Voice Distress is disabled	Voice Distress has been disabled - the Voice Distress service will not work.	The service can be reenabled in the web interface of the FleetBroadband terminal.
08079	Multi-voice control connection error	Not possible to establish connection to Multi-voice server	<p>Check that Multi-voice is included in your subscription.</p> <p>Check that the Multi-voice APN entered in the web interface under ADMINISTRATIO N > Multi-voice matches the Multi-voice APN from your airtime subscription</p>
0807C	Multi-voice register failed	Not possible to register on the Multi-voice server	Check that Multi-voice is included in your airtime subscription.

ID	Event Text	Explanation	Remedy
0900A	Antenna - Write verification fault in EEPROM	An EEPROM is defective or the EEPROM communication fails. The antenna is unable to save the last known frequency and elevation after entering track state. If the EEPROM is defective, data may be lost or inaccessible.	Power cycle the system. If the fault persists, contact your distributor.
0900C	Antenna - temperature too low	The temperature is too low for the antenna to work properly.	Leave the antenna on and wait for it to warm up.
0900D	Antenna - temperature too high	The temperature is too high for the antenna to work properly.	Switch off the system and let the antenna cool
09010	Antenna - Low RSSI level	If this fault occurs, the antenna is most likely unable to acquire a signal.	Ensure that the antenna is able to locate a satellite. If not, contact your distributor
0912A	Motor stopped	The motors in the antenna have stopped because the temperature is critically high or critically low.	When the temperature is normalized the motors automatically start up again.

Logging of events

Diagnostic report

When you contact your distributor for support, please include a diagnostic report.

The diagnostic report contains information relevant for the service personnel during troubleshooting.

To generate the diagnostic report, access the web interface and select **HELPDESK**. Then click **Generate report**.

Event log

The event log holds information of events registered in the terminal or antenna. The same events, when active, are also indicated in the Antenna and Terminal LEDs on the terminal LED panel.

The log includes the time of the occurrence, a short description, location of the error etc. This information can help troubleshooting errors in the system. You can see the event log in the web interface. For further information, see *To view the Event list or the Event log* on page 198.

Reset button

How to access the Reset button

The terminal has a Reset button placed next to the SIM slot behind the SIM cover. The functions of this button is described in the next section.

To push the Reset button, use a pointed device.



Function of the Reset button

The Reset button on the terminal has the following functions:

Action	Function
With the terminal running, press the Reset button normally.	The terminal IP address and IP netmask are temporarily set to the default value (default IP address: 192.168.0.1). With this function, even if the IP address has been changed and you do not remember the new IP address, you can still access the web interface and see your current configuration. The default value is not saved in the configuration, but is only valid until next reboot.
With the terminal running, press and hold the Reset button for 30 seconds, until the Power indicator on the terminal is flashing orange.	The terminal restores factory settings and reboots the system.
While the terminal is booting, press and hold the Reset button.	For service use only! The bootloader initiates software upload. Refer to the installation manual for details.

List of reserved IP subnets

Some IP subnets are reserved for internal use in the terminal. If any of these addresses are assigned to external equipment connected to the terminal, the terminal and connected equipment will not be able to communicate.

The following local IP subnets are reserved for internal use in the terminal. The netmask for all of these subnets is **255.255.255.0**.

192.168.2.0	192.168.17.0
192.168.3.0	192.168.18.0
192.168.4.0	192.168.19.0
192.168.5.0	192.168.20.0
192.168.6.0	192.168.21.0
192.168.7.0	192.168.22.0
192.168.8.0	192.168.23.0
192.168.9.0	192.168.24.0
192.168.10.0	192.168.25.0
192.168.11.0	192.168.26.0
192.168.16.0	

Supported AT commands for PPPoE

Overview of supported AT commands

You can use PPPoE to issue AT commands to the terminal, for example to specify the Quality of Service parameters or which APN to use.

The following AT commands are supported:

- AT+CGDCONT
- AT+CGEQREQ
- AT+CGEQMIN
- AT+CGTFT
- AT+CGDSCONT

Functions of the supported AT commands

AT+CGDCONT

Usage:

AT+CGDCONT is used to specify the Context parameters such as which APN the context must use.

This can be used to specify a specific APN different from the one on the SIM card.

Syntax:

AT+CGDCONT=<cid>,<protocol>,<APN>

- <cid> is the Context Identifier (1 – 11)
- <Protocol> is the transport protocol (IP or PPP)
- <APN> is the Access Point Name
- <PDP Addr> is the static IP address from APN (NOT USED!)

Example: AT+CGDCONT=1,ip,"bgan.inmarsat.com"

AT+CGEQREQ

Usage:

AT+CGEQREQ is the requested Quality of Service (QoS). This is used to specify the QoS for the connection. With this command you can start a Streaming context.

Syntax:

AT+CGEQREQ=<cid>,<Traffic Class>,<Max bitrate UL>,<Max bitrate DL>,<Guaranteed bitrate UL>,<Guaranteed bitrate DL>

- <cid> is the Context Identifier (1 – 11)
- <Traffic Class> is the traffic class (1 – Streaming, 3 – Background)
- <Max bitrate UL> is the maximum bit rate up link (0, 8, 16, 32, 64, 128, 256)
- <Max bitrate DL> is the maximum bit rate down link (0, 8, 16, 32, 64, 128, 256)
- <Guaranteed bitrate UL> is the guaranteed bit rate up link (0, 8, 16, 32, 64, 128, 256)
- <Guaranteed bitrate DL> is the guaranteed bit rate down link (0, 8, 16, 32, 64, 128, 256)

Example: AT+CGEQREQ=1,1,64,64,64,64

AT+CGEQMIN

Usage:

AT+CGEQMIN is the requested minimum acceptable Quality of Service (QoS). If the requested Quality of Service can not be offered by the Core Network, the data connection will not be established, not even with a lower QoS.

Syntax:

AT+CGEQMIN=<cid>,<Traffic Class>,<Max bitrate UL>,<Max bitrate DL>,<Guaranteed bitrate UL>,<Guaranteed bitrate DL>

- <cid> is the Context Identifier (1 – 11)
- <Traffic Class> is the traffic class (1 – Streaming, 3 – Background)
- <Max bitrate UL> is the maximum bit rate up link (8, 16, 32, 64, 128, 256)

- <Max bitrate DL> is the maximum bit rate down link (8, 16, 32, 64, 128, 256)
- <Guaranteed bitrate UL> is the guaranteed bit rate up link (8, 16, 32, 64, 128, 256)
- <Guaranteed bitrate DL> is the guaranteed bit rate down link (8, 16, 32, 64, 128, 256)

Example: AT+CGEQMIN=1,1,64,64,64,64

AT+CGTFT

Usage:

AT+CGTFT is the Traffic Flow Template (TFT). This command is needed if a secondary PDP context needs to be opened. The TFT specifies which IP traffic should run through which PDP context.

Syntax:

AT+CGTFT=<cid>,<packet filter identifier>,<evaluation precedence index>,<source address and subnet mask>,<protocol number>,<destination port range>,<source port range>

- <cid> is the Context Identifier (1 – 11)
- <packet filter identifier> is the packet filter identifier (1 – 8)
- <evaluation precedence index> This filter's Evaluation Precedence Index (0-255)
- <source addr & subnet> is (0.0.0.0.0.0.0-255.255.255.255.255.255.255.255)
- <protocol number> is the protocol number (0-255)
- <destination port range> is Destination Port From.To (0.0-65535.65535)
- <source port range> is Source Port From.To (0.0-65535.65535)

Example: AT+CGTFT=1,1,0,87.48.134.251.255.255.255.0,6,20.21,1024.65535

AT+CGDSCONT

Usage:

AT+CGDSCONT is used to specify the Secondary Contexts relation to a Primary Context. The Secondary Context's cid must be different from the Primary Context's cid. The Secondary Context's QoS must be set using the AT+CGEQREQ command explained above.

Syntax:

AT+CGDSCONT=<cid>,<p_cid>

- <cid> is the cid for the Secondary Context
- <p_cid> is the Primary Context at which the Secondary is related to.

Example: AT+CGDSCONT=1,11

Application example

This example shows the commands needed in order to establish a Primary Standard Data Context with a Secondary Streaming 256K Context where all UDP traffic goes through the Streaming 256K Data connection and all other traffic goes through the Standard Data connection.

- AT+CGDCONT=1,ip,bgan.inmarsat.com
(Specifies the APN)
- AT+CGEQREQ=1,3
(Sets cid 1 = Standard data)
- AT+CGTFT=11,1,0,,17
(Sets UDP TFT filter for cid 11)
- AT+CGEQREQ=11,1,256,256,256,256
(Sets cid 11 = Streaming 256K QoS)
- AT+CGEQMIN=11,1,256,256,256,256
(Specifies min. acceptable QoS to Streaming 256K)
- AT+CGDSCONT=11,1
(Defines Secondary cid 11 on Primary cid 1)

If you have any technical questions about the PPPoE feature please refer to your local distributor, who can assist you with the configuration.

Conformity

SAILOR 500 FleetBroadband

CE

The SAILOR 500 FleetBroadband is CE certified as stated in the simplified EU Declaration of Conformity, enclosed in copy on the next page.

Note

The simplified EU Declaration of Conformity covers all variants of the terminal, but the full version of the EU Declaration of Conformity is available on the Cobham SATCOM web site in separate versions for each variant.

EU Declaration of Conformity

Hereby **Thrane & Thrane A/S trading as Cobham SATCOM** declares that the following equipment complies with the specifications of:

RED directive 2014/53/EU concerning Radio Equipment

Equipment included in this declaration

Model	Description	Part no.
TT-3740A	SAILOR 500 Fleet Broadband System	403740A

The full text of the EU declaration of conformity is available at the following internet address:

<http://sync.cobham.com/satcom/support/downloads>

RED

Document no.: 99-157455-A

SAILOR 250 FleetBroadband

CE

The SAILOR 250 FleetBroadband is CE certified as stated in the simplified EU Declaration of Conformity, enclosed in copy on the next page.

Note

The simplified EU Declaration of Conformity covers all variants of the terminal, but the full version of the EU Declaration of Conformity is available on the Cobham SATCOM web site in separate versions for each variant.

EU Declaration of Conformity

Hereby **Thrane & Thrane A/S trading as Cobham SATCOM** declares that the following equipment complies with the specifications of:

RED directive 2014/53/EU concerning Radio Equipment

Equipment included in this declaration

Model	Description	Part no.
TT-3742A	SAILOR 250 Fleet Broadband System	403742A

The full text of the EU declaration of conformity is available at the following internet address:

<http://sync.cobham.com/satcom/support/downloads>

RED

Document no.: 99-157454-A

A

APN Access Point Name. The Access Point Name is used by the terminal operator to establish the connection to the required destination network.

B

BGAN Broadband Global Area Network. A satellite network based on geostationary satellites, delivering broadband data to virtually any part of the earth, with full UMTS (3G) compatibility.

C

CE Conformité Européenne. This term signifies that a CE certified product conforms to European health, environmental, and safety regulations. In short, it makes the product legal to be sold in the European Union.

CID Context Identifier

CM Continuous Monitoring

CS Circuit-Switched. Circuit-switched networks require dedicated point-to-point connections during calls.

D

DHCP Dynamic Host Configuration Protocol. A protocol for assigning dynamic IP addresses to devices on a network. With dynamic addressing, a device can have a different IP address every time it connects to the network.

DNS Domain Name System. A system translating server names (URLs) to server addresses.

E

- ECEF** The Earth-Centred Earth-Fixed or conventional terrestrial coordinate system rotates with the Earth and has its origin at the centre of the Earth. The X axis passes through the equator at the prime meridian. The Z axis passes through the north pole but it does not exactly coincide with the instantaneous Earth rotational axis. The Y axis can be determined by the right-hand rule to be passing through the equator at 90 degrees longitude.
- EMEA** Europe, Middle-East and Africa

G

- G.3 fax** Group 3 fax. A digital format for transmitting fax messages over a traditional phone line. Conforms to the ITU-T Recommendations T.30 and T.4.
- Geostationary** Placed in a fixed position relative to a point on the surface of the earth.
- GNSS** Global Navigation Satellite System. A satellite navigation system with global coverage. Examples are GPS, GLONASS or Beidou.
- GPS** Global Positioning System. A system of satellites, computers, and receivers that is able to determine the latitude and longitude of a receiver on Earth by calculating the time difference for signals from different satellites to reach the receiver.

I

- I/O** Input/Output
- IAI-2** Inmarsat Air Interface-2. The air interface used for BGAN. IAI-2 is an evolution of MPDS with new bearer types, which give a wide range of data rates from 16 kbps up to 492 kbps. By

utilizing different modulation schemes, variable coding rate and power adjustment, it is possible to change the bearer type to give optimum throughput with efficient use of the satellite resources.

ICMP Internet Control Message Protocol. An Internet protocol mostly used for diagnostics.

IMEI International Mobile Equipment Identity. A unique number identifying your terminal

IMSO International Maritime Satellite Organisation. An intergovernmental body established to ensure that Inmarsat continues to meet its public service obligations, including obligations relating to the GMDSS.

IP Internet Protocol

ISDN Integrated Services Digital Network. A circuit-switched telephone network system, designed to allow digital transmission of voice and data over ordinary telephone copper wires.

K

kbps kilobits per second

L

LAN Local Area Network

LED Light Emitting Diode

M

MAC Media Access Control

MB Mega Bytes

MRCC	Maritime Rescue Coordination Centre
MSN	Multiple Subscriber Numbering. In most pieces of ISDN equipment you can program multiple subscriber numbers. The number programmed into the equipment should be the dial-in number that you wish that piece of equipment to answer.
N	
NAT	Network Address Translation. An Internet standard that enables a local-area network to use one set of IP addresses for internal traffic and a second set of addresses for external traffic. A NAT module makes all necessary address translations.
P	
PDP	Packet Data Protocol. A network protocol used by external packet data networks that communicate with a GPRS network.
PIN	Personal Identification Number. A code number used to provide access to a system that has restricted access.
PoE	Power over Ethernet
POST	Power On Self Test. A test sequence that runs every time the system is powered up or reset.
PPPoE	Point-to-Point Protocol over Ethernet. A network protocol for encapsulating Point-to-Point Protocol (PPP) frames inside Ethernet frames. By using PPPoE, users can virtually "dial" from one machine to another over an Ethernet network, establish a point to point connection between them and then securely transport data packets over the connection.
PS	Packet-Switched. Packet-switched networks move data in separate, small blocks (packets) based on the destination address in each packet.

PUK PIN Unlocking Key. An eight-digit code used to unblock a SIM card after three incorrect PINs have been entered. The PUK code is supplied with the SIM card.

Q

QoS Quality of Service

R

RDI Restricted Digital Information

RF Radio Frequency. Electromagnetic wave frequencies between about 3 kilohertz and about 300 gigahertz including the frequencies used for communications signals (radio, television, cell-phone and satellite transmissions) or radar signals.

S

SAS Satellite Access Station. The gateway between the satellites and the worldwide networks such as Internet, telephone network, cellular network etc.

SDU Service Data Unit. Also known as a data packet.

SIM Subscriber Identity Module. The SIM provides secure storing of the key identifying a mobile phone service subscriber but also subscription information, preferences and storage of text messages.

SIP Session Initiation Protocol. An application-layer control (signalling) protocol for creating, modifying, and terminating sessions with one or more participants. Used e.g. for Internet telephony.

SMS Short Messaging Service

Streaming A technique for transferring data - such as audio or video - as a

continuous stream. With a Streaming connection you are charged by the minute, like for a telephone connection.

T

TCP Transmission Control Protocol. One of the core protocols of the Internet protocol suite. TCP provides reliable, in-order delivery of a stream of bytes, making it suitable for applications like file transfer and e-mail.

U

UDI Unrestricted Digital Information

UTC Coordinated Universal Time. The International Atomic Time (TAI) with leap seconds added at irregular intervals to compensate for the Earth's slowing rotation. Leap seconds are used to allow UTC to closely track UT1, which is mean solar time at the Royal Observatory, Greenwich.

V

VoIP Voice over IP. The routing of voice conversations over the Internet or through an IP-based network.

VPN Virtual Private Network. A network that is constructed by using public wires to connect nodes. You can create networks using the Internet for transporting data, using security mechanisms so that only authorized users can access the network.

Numerics

- 2-wire interface
 - local numbers, 51
 - setting call type, 112

A

- access to settings
 - limit in web interface, 182
- activation
 - remote, 186
- additional numbers
 - description, 61
 - enable, 191
 - IP Handsets, 130
 - ISDN interface, 114
 - Phone interface, 112
- administration settings, 164
- administration, remote, 184
- allowed numbers
 - restricted dialing, 189
- analogue phone
 - local numbers, 51
- antenna
 - serial number, 103
 - viewing properties, 103
 - viewing status, 84
 - viewing type, 84, 200
- antenna RF noise filter, 195
- APN, common setting, 117
- assigned numbers, 61
- ATC resilience, 195
- Audio echo canceller
 - ISDN, 116
- audio quality, 43

- automatic shut down
 - connection, 170

B

- barring calls, 121
- BGAN
 - connecting to, 30
 - coverage, 12
 - services, 14
 - system overview, 13
- Bridge mode, 147
- browser settings
 - for web interface, 78

C

- call
 - barring, 121
 - closed user group, 124
 - Distress, 63
 - forwarding, 119
 - holding, 54
 - line identification, 123
 - local, 50
 - making or receiving, 46
 - missed, received, outgoing, 95
 - redial, 51
 - to specific handset, 125
 - to the terminal, 48
 - transferring, 55
 - waiting indication, 53, 122
- call limiting, 189
- call log, 93

- call type, 43
 - setting for IP handsets, 130
 - setting for ISDN, 115
 - setting for Phone/Fax interface, 112
- calls
 - simultaneous (Multi-voice), 15
 - viewing ongoing, 86
- CE compliance, 243
- clearing logs, 169, 170
- clearing usage counter, 169
- closed user group, 124
- common network settings, 117
- compression, header, 155
- computer, connecting to LAN, 26
- configuration
 - exporting to file, 167
 - importing from file, 167
 - ISDN, 114
 - LAN, 104
- conformity, 243
- connecting to the BGAN network, 30
- connection
 - automatic shut down, 170
- connector panel, 20
- contact information, 201
- coverage
 - Inmarsat BGAN system, 12

D

- dashboard, 83
- data
 - limit, 170
 - profiles, 171
 - traffic flow filters, 176
- data limit
 - automatic shutdown, 171
- data limits, setting, 170

- data sessions
 - viewing ongoing, 86
- Declaration of Conformity, 244, 246
- default
 - IP address, 79
 - network setup, 66
- dialing prefixes, 52
- dialing restrictions, 189
- document number
 - installation manual, vii
 - IP handset manual, vii
 - this manual, i

E

- echo canceller
 - ISDN, 116
- Ethernet interface
 - setting up, 104
- events
 - in LED panel, 217
 - list of active, 198
- exporting configuration, 167
- extended status, 200
- external access, 184
- external IP address, viewing, 86

F

- fax, sending or receiving, 56
- features overview, 3
- filter for ATC, 195
- forwarding calls, 119

H

- handset
 - call specific, 125

handset contexts for Multi-voice, 59
Header compression, 155
help desk number, 197
 changing in web interface, 197
holding a call, 54

I

ignition function, 23
IMEI number, 84
importing configuration, 167
Inbox for SMS messages
 replying, forwarding or deleting, 100
indicator functions, 213
installation manual
 document number, vii
interfaces and services
 combinations, 17
internal calls, 50
Internet connection, 26
IP address
 external, setting up, 147
 external, viewing, 86
 for connected device, 150
 for web interface, 79
 local, setting up, 106
 local, viewing, 84
 reserved, 237
IP connection
 monitoring, 187

IP handset
 BGAN features, 38
 connecting, 25
 entering PIN, 28
 local numbers, 51
 manual, vii
 power supply, 25
 setting call type, 130
 setting up, 127
 starting up, 25
IP Handsets
 assigning additional numbers, 130
IP subnet
 reserved, 237
ISDN interface
 assigning additional numbers, 114
 Audio echo canceller, 116
 local numbers, 51
 setting up, 114

L

LAN
 connecting a computer, 26
 managing network users, 142
 setting up interface, 104
L-Band interface
 enabling or disabling, 104
LED functions, 213
light indicator functions, 213
limit
 allowed MB, 171
 data, 170
limit calls, 189
limitations in services, 16
limiting user access, 182
line identification, 123
link monitoring, 187

- local exchange, 125
- local numbers assigned, 51
- local phone call, 50
- logs, clearing, 169, 170

M

- MAC address, 84
- manual
 - document number, i
- matrix of services and interfaces, 17
- maximum for data, 170
- messages
 - configuring outgoing, 101
 - forwarding, 100
 - opening in web interface, 100
 - receiving in web interface, 99
 - replying, 100
 - sending, 98
- microwave radiation, iii
- mobile numbers
 - viewing and editing, 91
- monitoring the external IP connection, 187
- Multi-voice
 - additional numbers, 61
 - description, 58
 - enabling, 191
 - handset contexts, 59
 - short description, 15

N

- navigation in web interface, 81
- network classification table, 152
- network devices, 150
- network management, 142
- network setup, default, 66

- network terms
 - definitions, 155

O

- Outbox for SMS messages
 - resending or deleting messages, 97

P

- permissions
 - setting for users, 182
- phone
 - local call, 50
 - making calls, 46
- phone book, 87
 - adding number, 90
 - deleting all entries, 90
 - deleting an entry, 90
 - limited numbers, 189
 - modifying an entry, 90
- Phone interface
 - assigning additional numbers, 112
- phone numbers for terminal, 91
- Phone/Fax interface
 - local numbers, 51
 - setting call type, 112
- PIN
 - administration PIN, 164
 - changing, 181
 - enabling or disabling, 180
 - entering, 27
 - entering in web interface, 29
 - entering with a phone, 27
 - entering with IP handset, 28
- ping command from the terminal, 187
- PoE, 25
- port forwarding, 107

Power over Ethernet, 25
power supply for IP handset, 25
powering the terminal, 21
PPPoE
 enabling, 109
 using, 72
prefixes, special-purpose, 52
profiles for data transmission, 171
properties
 antenna, 103
 system, 84
Proxy server, disabling, 78
PUK code, 28, 30

Q

quality of voice, 43
Quick dial, 46

R

radiation, iii
redial, 51
registering on the BGAN network, 30
remote activation
 by SMS, 187
 trusted mobile number, 187
remote control, 186
remote management, 184
remote on/off, 23
restricted dialing, 189
rights for users
 in web interface, 182
router function, 64
Router mode, 147

S

safety
 Voice Distress, 63
safety summary, iii
satellite
 selecting, 162
 view selected, 85
sent messages
 resending, forwarding or deleting, 98
 viewing status, 98
serial number, 84
 antenna, 103
services
 limitations, 16
 Multi-voice, 15
 supplementary, 114
 supported by BGAN, 14
 Voice Distress, 15
services and interfaces
 combinations, 17
settings
 limit access, 182
Short dial, 46
show number, 123
SIM lock, 16
site map of web interface, 200
SMS activation, 187
SMS in web interface
 forwarding, 100
 opening, 100
 receiving, 99
 replying to, 100
 sending, 98
SMS service number, 102
software
 uploading with TMA, 202
 uploading with web interface, 158
 viewing version, 84

Standard IP, 64
 activating, 65, 67
 definition, 64
status
 air interface, 200
 connection, 200
 extended, 200
 methods for signalling, 213
 ongoing calls and data sessions, 86
 viewing, 83
streaming class
 time limit, 170
Streaming IP, 64
 activating, 67
 definition, 64
subnet
 IP, reserved, 237
supplementary services
 setting up, 114
 supported, 16
 using, 53
support
 contact information, 201

T

telephone interface
 local numbers, 51
 setting call type, 112
tools for setting up the terminal, 37
total usage
 viewing, 86, 93
tracking, 138
traffic flow filters, 176
transferring a call, 55
troubleshooting guide, 206
trusted mobile number, 187
typography used in this manual, viii

U

uploading software
 with TMA, 202
 with web interface, 158
usage counter, 86, 93
 clearing, 169
user interfaces, 37
user permissions
 setting up in web interface, 182

V

version of software, 84
Voice Distress
 description, 63
 service, 15
voice mail number
 viewing, 102
voice quality, 43
 setting for IP handsets, 130
 setting for ISDN, 115
 setting for Phone/Fax interface, 112

W

waiting calls, 53, 122
warranty, 201
web interface
 accessing, 77
 browser settings, 78
 definition, 77
 navigation, 81
 site map, 200

