



 **UNITECK**

**FRENCH MANUFACTURER
OF OFF-GRID SMALL POWER
SOLAR EQUIPMENT**



**A FRENCH INDUSTRIAL
DESIGNING, MANUFACTURING AND MARKETING
INNOVATIVE AND HIGH QUALITY PRODUCTS**

Uniteck is an innovative French industrial company specialized in small power solar energy, whose headquarters are located in Béziers (34). Based on their 10 years of experience in the professional charger field, the founders have created a tailor made range of products for the following target markets:
campervan, boating, road signs and small domestic applications.

Uniteck markets all the products required for a complete and efficient solar installation, including :

- solar charge controllers, designed and made in France
- high efficiency solar panels
- advanced inverters
- many mountings brackets and high quality accessories

Uniteck stands as the reference supplier of solar solutions thanks to their products :

- which are easy to use and reliable
- with ergonomic and discreet design
- totally safe for the user..



Vendres (Béziers-France) :
Headquarters and sales management/
mechanical, plastic and electronic
design department

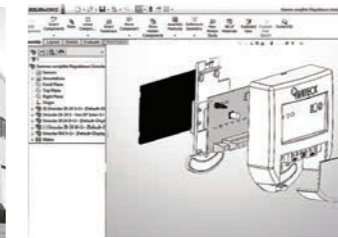

Logistics/
production department



Shanghai-China :
Sourcing/quality control department

THE SMALL OFF-GRID SOLAR POWER SOLUTIONS EXPERT



Campervan



Boating

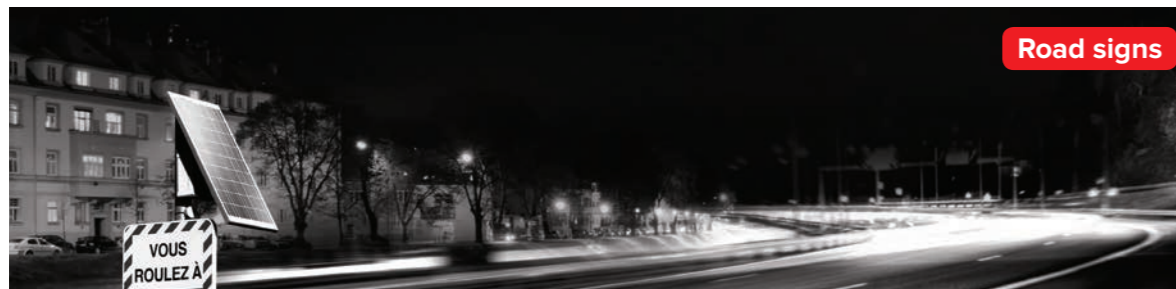

Road signs



Domestic applications



Leisure

A "MADE IN FRANCE" BRAND



Aesthetic and didactic products



A multilingual website (with user manuals, datasheets, pictures for download...)



A detailed product documentation



A full range of high-quality products

Documents and tools to guide the user, dedicated to every application



PRODUCT



p.8

**Rigid solar panels
UNISUN M & BC**



Quality guaranteed by Uniteck



p.12

**Flexible solar panels
UNISUN MF**



Quality guaranteed by Uniteck



p.14

**Mounting brackets
UNIFIX**



Designed, made in France

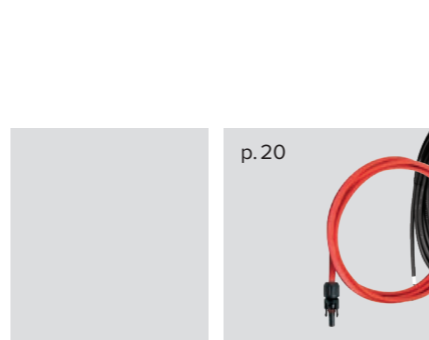

p.20

**Wiring
Panel(s) > Charge controller > Battery(ies)**



Designed, made in France



p.22

**PWM solar charge controller
UNISOLAR**



Designed, made in France



p.26

**MPPT solar charge controller
UNIMPPT**



Designed, made in France



p.32

**AGM batteries
UNIBAT**



Quality guaranteed by Uniteck



p.34

**GEL batteries
UNIBAT**



Quality guaranteed by Uniteck



p.36

**Inverters
UNIPOWER**



Quality guaranteed by Uniteck

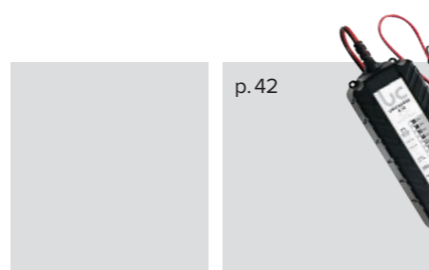

p.42

**Battery chargers
UNICHARGE**



Quality guaranteed by Uniteck



p.44

**Battery isolators
UNIMOS**



Designed, made in France



p.46

12 V accessories



Quality guaranteed by Uniteck

GUIDE



p.49

Road signs



p.50

Campervan



p.52

Leisure



p.54

Boating

UNISUN M



Monocrystalline module:
series connections on the front face
of the cells



10% of the surface is hidden by the
electrical connections

ex. panels with 125 x 125 cells

intensity (Imp)	2,5-2,8 A
voltage (Vmp)	0,5-0,52 V
electrical contact	front contact
cell efficiency	15-20%
number of cells necessary for battery charging	36 cells (36 × 0,5 V) = 18 V
compactness of panel	++
saving money	+++

UNISUN BC

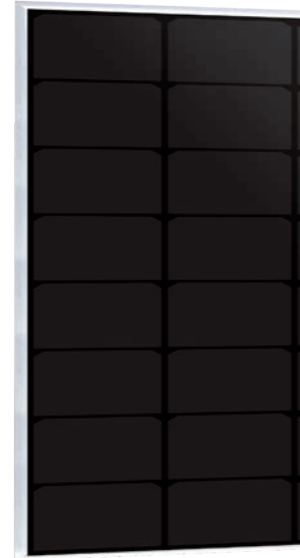

Back contact module:
series connections on the back
of the cells



No areas covered on the front face

ex. panels with 125 x 125 cells

intensity (Imp)	3,2-3,3 A
voltage (Vmp)	0,56-0,57 V
electrical contact	back contact
cell efficiency	23-24%
number of cells necessary for battery charging	32 cells (32 × 0,57 V) = 18 V
panel compactness	+++
saving money	++



HIGH QUALITY STRUCTURE

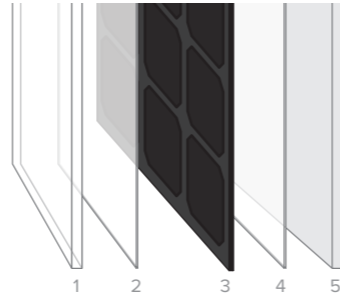

1. Tempered glass 3.2mm, high transmissibility (low iron content)
2. EVA Resin 0,45mm
3. Highly efficient cells
4. EVA Resin 0,45mm
5. Frame (anodised aluminium)

QUICK CONNECTORS

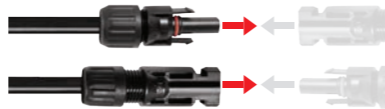

ANTI HOT-SPOT



Protection against Hot-spots
and surges

Rigid solar panels UNISUN M & BC

HIGH EFFICIENCY

UNISUN is the high performance monocrystalline panel range for leisure (boating and campervan) or off-grid activities and road signs.

Their multi-layer structure ensures exceptional output, even under weak light or extreme heat.

Their highly transmissible tempered glass and their anodized aluminium frame preserve them from external damage (impacts, oxidation, corrosion).

Upgradable for more power, connecting them in series or in parallel is facilitated thanks to their quick solar connectors.

The UNISUN range is available with standard monocrystalline cells and back contact monocrystalline cells. UNISUN Back Contact (electrical contact at the back) disposes of all the cells' surface to capture light energy.

At equal power, thanks to their higher efficiency (power / surface ratio), the back contact panels offer the advantage of being more compact and are therefore ideal for uses where space and weight are important.

UNITECK

Highly efficient cells

Excellent impact and weight resistance (tempered glass 3.2 + aluminium frame)

TÜV certified water-proof junction box with hot-spot protection

Exceptional output even under weak light

Quality guaranteed
by Uniteck
Made in P.R.C.

EN61215
et EN61730

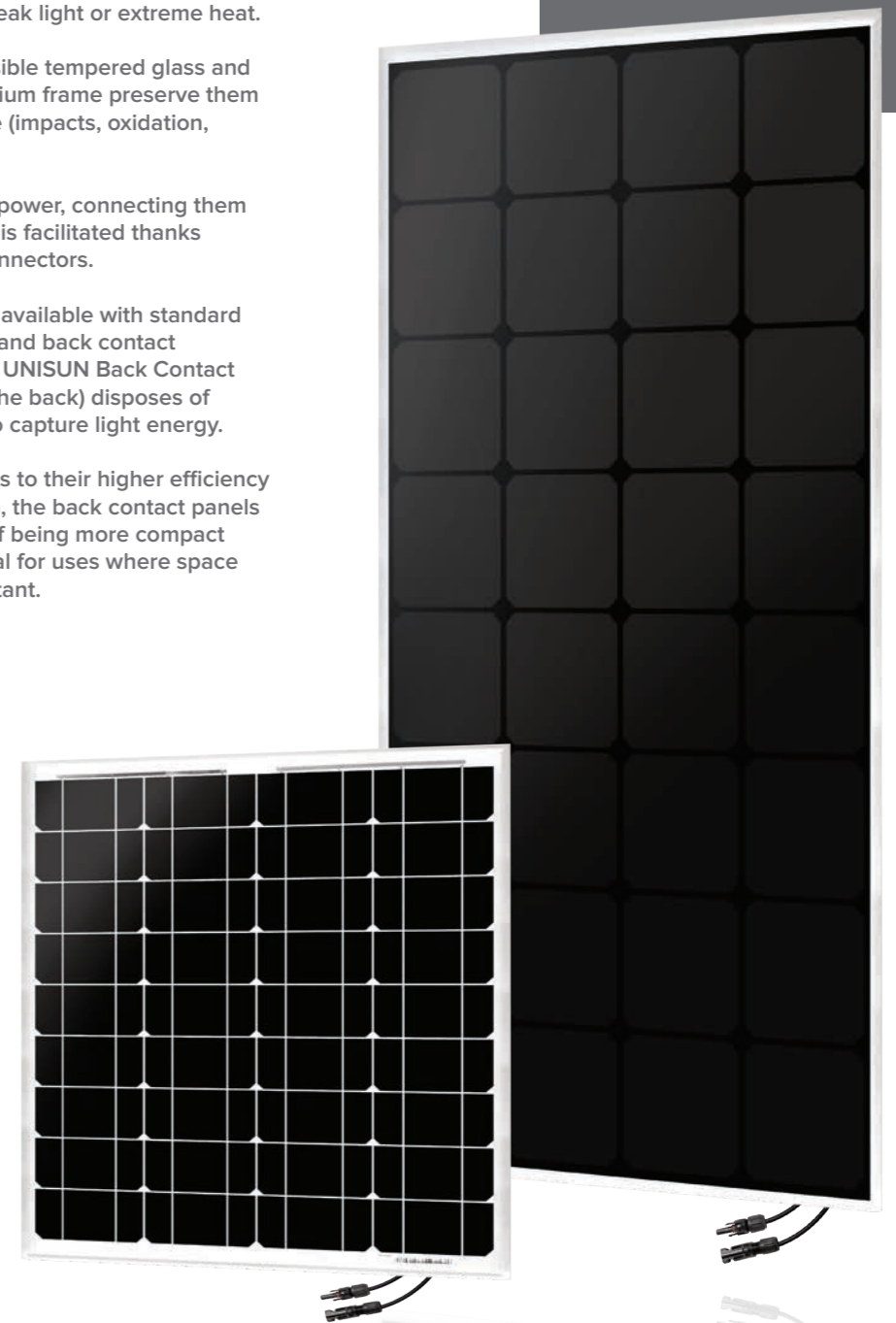

UNISUN M & BC rigid solar panels

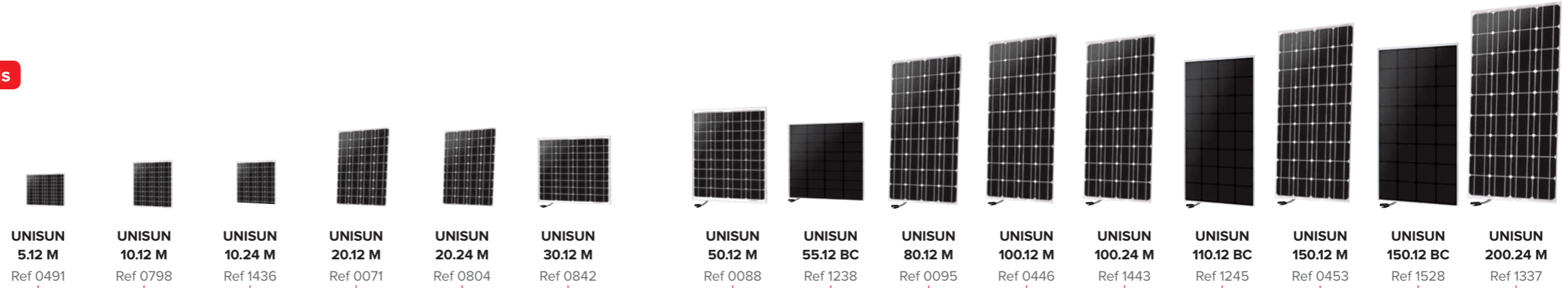

Electrical Performance

	UNISUN 5.12 M Ref 0491	UNISUN 10.12 M Ref 0798	UNISUN 10.24 M Ref 1436	UNISUN 20.12 M Ref 0071	UNISUN 20.24 M Ref 0804	UNISUN 30.12 M Ref 0842	UNISUN 50.12 M Ref 0088	UNISUN 55.12 BC Ref 1238	UNISUN 80.12 M Ref 0095	UNISUN 100.12 M Ref 0446	UNISUN 100.24 M Ref 1443	UNISUN 110.12 BC Ref 1245	UNISUN 150.12 M Ref 0453	UNISUN 150.12 BC Ref 1528	UNISUN 200.24 M Ref 1337
Max. power (Pm)*	5 W	10 W	10 W	20 W	20 W	30 W	50 W	55 W	80 W	100 W	100 W	110 W	150 W	150 W	200 W
Power tolerance*	0/+3 %	0/+3 %	0/+3 %	0/+3 %	0/+3 %	0/+3 %	0/+3 %	0/+3 %	0/+3 %	0/+3 %	0/+3 %	0/+3 %	0/+3 %	0/+3 %	0/+3 %
Operating voltage	12 V	12 V	24 V	12 V	24 V	12 V	12 V	12 V	12 V	12 V	24 V	12 V	12 V	12 V	24 V
Technology	mono	mono	mono	mono	mono	mono	mono	back contact	mono	mono	mono	back contact	mono	back contact	mono
Voltage at max. power (Vmp)*	17,4 V	17,6 V	35,2 V	17,8 V	35,2 V	17,8 V	17,8 V	18,6 V	17,8 V	17,8 V	36,6 V	18,6 V	17,8 V	27 V	35,6 V
Intensity at max. power (Imp)*	0,29 A	0,57 A	0,29 A	1,12 A	0,57 A	1,69 A	2,81 A	2,96 A	4,49 A	5,62 A	2,81 A	5,91 A	8,43 A	5,67 A	5,62 A
Voltage in open circuit (Voc)*	21,6 V	21,77 V	43,54 V	22,3 V	43,54 V	22,3 V	22,3 V	21,8 V	22,3 V	22,3 V	42,7 V	21,9 V	21,3 V	32,4 V	42,7 V
Intensity in short circuit (Isc/ ISC)*	0,32 A	0,65 A	0,33 A	1,21 A	0,65 A	1,82 A	3,03 A	3,13 A	4,85 A	6,07 A	3,04 A	6,39 A	9,10 A	6,12 A	6,07 A
Min. Intensity IMR Controller (=Imp +25%)	0,40 A	0,81 A	0,36 A	1,51 A	0,81 A	2,28 A	3,79 A	3,91 A	6,06 A	7,59 A	3,80 A	7,99 A	11,38 A	7,08 A	7,59 A
Cell efficiency	20,60%	20,60%	18,4 %	20,60%	20,60%	20,60%	20,60%	23,80%	20,60%	20,60%	20,60%	23,80%	20,60%	23,80%	20,60%
Module efficiency*	7,56%	11,52%	11,52 %	12,65%	12,65%	11,86%	14,20%	18,18%	15,15%	15,15%	15,15%	19,05%	16,58%	18,67%	15,67%

Temperature characteristics

	UNISUN 5.12 M	UNISUN 10.12 M	UNISUN 10.24 M	UNISUN 20.12 M	UNISUN 20.24 M	UNISUN 30.12 M	UNISUN 50.12 M	UNISUN 55.12 BC	UNISUN 80.12 M	UNISUN 100.12 M	UNISUN 100.24 M	UNISUN 110.12 BC	UNISUN 150.12 M	UNISUN 150.12 BC	UNISUN 200.24 M
Operating temperature	-40 > +85°C	-40 > +85°C	-40 > +85°C	-40 > +85°C	-40 > +85°C	-40 > +85°C	-40 > +85°C	-40 > +85°C	-40 > +85°C	-40 > +85°C	-40 > +85°C	-40 > +85°C	-40 > +85°C	-40 > +85°C	-40 > +85°C
NOCT / TUC**	45 ±2°C	45 ±2°C	45 ±2°C	45 ±2°C	45 ±2°C	45 ±2°C	45 ±2°C	45 ±2°C	45 ±2°C	45 ±2°C	45 ±2°C	45 ±2°C	45 ±2°C	45 ±2°C	45 ±2°C
Temperature coefficient	Pm	-0,43%/°C	-0,48%/°C	-0,48 %/°C	-0,48%/°C	-0,48%/°C	-0,43%/°C	-0,3%/°C	-0,43%/°C	-0,43%/°C	-0,43%/°C	-0,3%/°C	-0,43%/°C	-0,3%/°C	-0,43%/°C
	Voc	-0,34%/°C	-0,34%/°C	-0,34 %/°C	-0,34%/°C	-0,34%/°C	-0,34%/°C	-0,28%/°C	-0,34%/°C	-0,28%/°C	-0,34%/°C	-0,28%/°C	-0,34%/°C	-0,28%/°C	-0,34%/°C
	Isc	0,05%/°C	0,037%/°C	0,037 %/°C	0,037%/°C	0,037%/°C	0,05%/°C	0,05%/°C	0,05%/°C	0,05%/°C	0,05%/°C	0,05%/°C	0,05%/°C	0,05%/°C	0,05%/°C

Mechanical characteristics

	UNISUN 5.12 M	UNISUN 10.12 M	UNISUN 10.24 M	UNISUN 20.12 M	UNISUN 20.24 M	UNISUN 30.12 M	UNISUN 50.12 M	UNISUN 55.12 BC	UNISUN 80.12 M	UNISUN 100.12 M	UNISUN 100.24 M	UNISUN 110.12 BC	UNISUN 150.12 M	UNISUN 150.12 BC	UNISUN 200.24 M
Anodised aluminium frame	yes	yes	yes	yes	yes	yes	yes	yes	yes	yes	yes	yes	yes	yes	yes
Cell dimensions (mm)	52 × 14,82	78 × 19,5	78×9,75	156 × 19,5	156 × 9,75	156 × 26	125 × 62,5	125 × 62,5	156 × 78	125 × 125	125 × 62,5	125 × 125	156×156	125 × 125	125×62,5
Number of cells	36 (18×2)	36 (12×3)	72 (24×3)	36 (12×3)	72 (24×3)	36 (18×2)	36 (12×3)	32 (8×4)	36 (9×4)	36 (9×4)	72 (18×4)	32 (8×4)	36 (9×4)	45 (9×5)	72 (12×6)
Module dimensions (mm)	216×306×18	310×280×35	310×280×35	510×310×35	510×310×35	460×550×35	640×550×35	550×550×35	960×550×35	1200×550×35	1200×550×35	1050×550×35	1340×675×35	1190×675×35	1580×808×40
Cable length (with connectors)	-	-	-	-	-	900 mm	900 mm	900 mm	900 mm	900 mm	900 mm	900 mm	900 mm	900 mm	900 mm
Module weight	0,8 kg	1,3 kg	1,3 kg	2 kg	2 kg	3,1 kg	4,1 kg	3,8 kg	6,3 kg	7,5 kg	7,5 kg	7,0 kg	9,8 kg	9,3 kg	13,6 kg

* According to standard test conditions (STC): irradiance 1000 W/m², AM= 1,5, cell temperature 25°C
 ** Nominal Operating Cell Temperature: Irradiance 800 W/m², wind speed 1 m/s, ambient temperature 25°C

i Intensity/voltage curve depending on the solar radiation

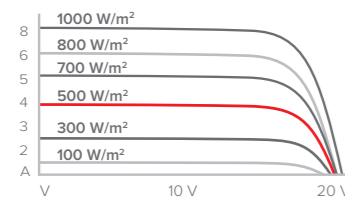

Example of 150W panel
 • in Lille :
 winter= 200W/m²
 summer= 700W/m²
 • in Marseille :
 winter= 500 W/m²
 summer= 850 W/m²

UPGRADABLE SETTINGS

Series connection: for your 24V batteries

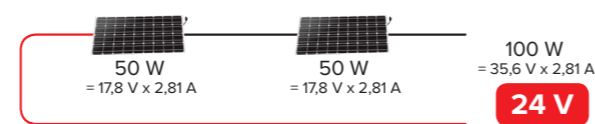

Parallel connection: For more power (Watt)

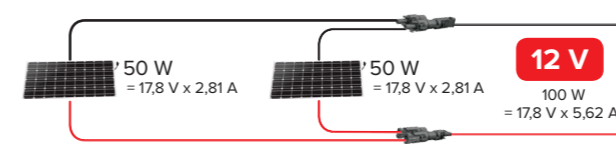

	20 W	40 W	100 W	150 W	300 W
UNISUN 20.12M	×1	×2	-	-	-
UNISUN 50.12M	-	-	×2	×3	-
UNISUN 150.12M	-	-	-	-	×2
UNICONNECT 1.6	×1	×1	×1	×1	×1
Parallel connectors kit	-	2 pan.	2 pan.	3 pan.	2 pan.



Electrical Performance

	50 W	100 W	150 W
Max. power (Pm)*	50 W	100 W	150 W
Power tolerance*	0/+3%	0/+3%	0/+3%
Operating voltage	12 V	12 V	12 V

Technology

	mono/flexible	mono/flexible	mono/flexible
Voltage at max. power (Vmp)*	18,5 V	18,7 V	18,7 V
Intensity at max. power (Imp)*	2,7 A	5,43 A	8 A
Voltage in open circuit (Voc)*	22,7 V	22,4 V	22,4 V
Intensity in short circuit (Icc/ ISC)*	2,84 A	5,66 A	8,41 A
Min. Intensity IMR Controller (=Imp +25%)	3,37 A	6,79 A	10 A
Cell efficiency	21%	21%	21%
Module efficiency*	13,23%	14,49%	14,02%

Temperature characteristics

Operating temperature	-40/+85°C	-40/+85°C	-40/+85°C
NOCT / TUC**	45 ±2°C	45 ±2°C	45 ±2°C
Temperature coefficient	Pm	-0,48%/°C	-0,48%/°C
	Voc	-0,34%/°C	-0,34%/°C
	Icc	0,037%/°C	0,037%/°C

Mechanical characteristics

Front structure	ETFE	ETFE	ETFE
Back structure	fiberglass	fiberglass	fiberglass
Cell dimensions	125×62,5 mm	125×125 mm	156×156 mm
Number of cells	36 (4×9)	36 (4×9)	36 (4×9)
Module dimensions (cm)	71,2×56×2	127,5×56×2	158×69,5×2
Cable length (with connectors)	900 mm	900 mm	900 mm
Fixing eyelet (marine bronze)	×4	×8	×8
Module weight	1,5 kg	2,5 kg	3,8 kg

* According to standard test conditions (STC): irradiance 1000 W/m², AM=1,5, cell temperature 25C
 ** Nominal operating Cell Temperature: Irradiance 800 W/m², wind speed 1m/s, ambient temperature 25C



Deck-pass/ bulkhead pass resistant to UV with quick solar connectors
Ref. 1481



Caps for solar connectors kit
1 male + 1 female
Ref 0170

HIGH QUALITY COATING

Entry-level price range	UNISUN MF
Light transmission	90-93%
Antireflexion properties	+
Self-cleaning properties	+
Corrosion resistant	+
Resistant to a saline environment	+

HIGH QUALITY JUNCTION BOX

Entry-level price range	UNISUN MF
TÜV Certification	rare
Cell protection from surges (hot-spots)	no
Mechanical resistance	+
Waterproof	+
Shape	not streamlined

HIGH QUALITY STRUCTURE

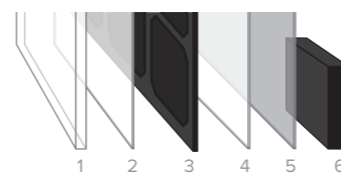

1. High quality ETFE plastic
2. EVA Resin
3. Highly efficient cells
4. EVA resin
5. PET + fiberglass
6. TÜV certified junction box



- High efficiency cells
- High resistance plastic, anti-corrosion, high transmissibility of light
- TÜV certified waterproof junction box with hot-spot protection
- Exceptional output even under weak light

Flexible solar panels UNSIUN MF

LIGHT AND MOBILE

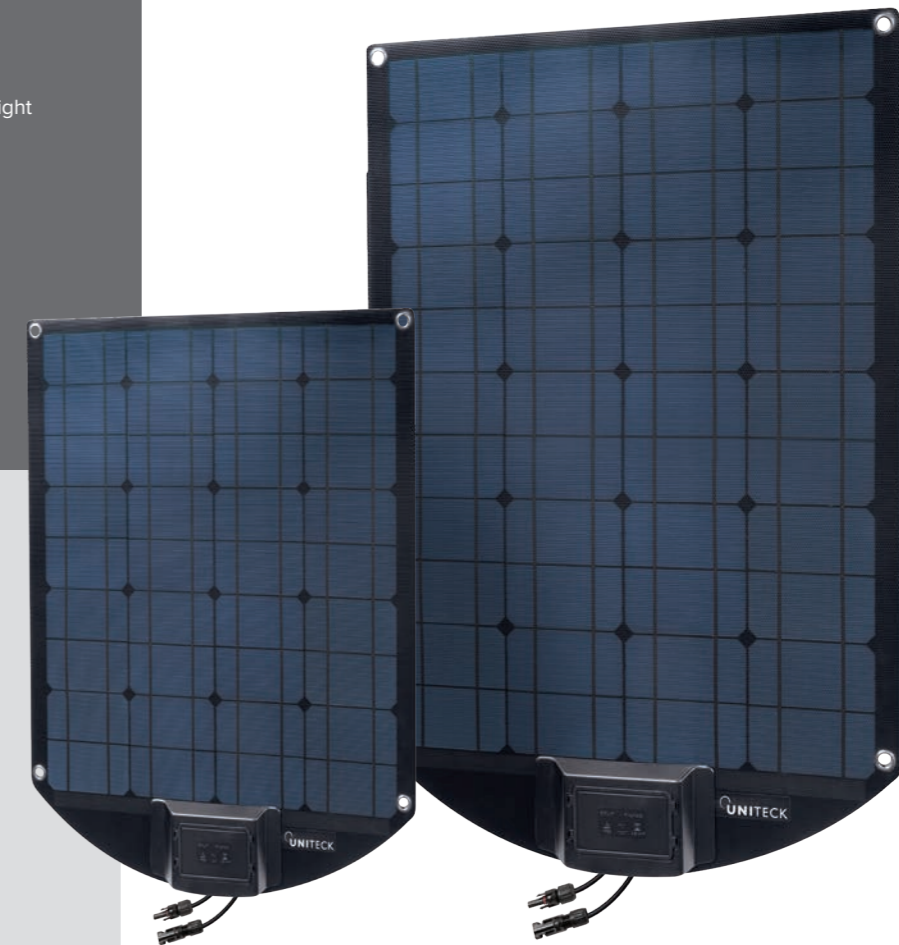

QUICK CONNECTORS

with built-in anti-reverse current diode, to facilitate the connection while protecting your installation (waterproof, reverse current).

UNISUN MF it's the high performance monocrystalline flexible panel range ideal for leisure (boating, campervan), off-grid or nomad activities

Their highly efficient monocrystalline cells guarantee exceptional output even under weak light or extreme heat. Their multi-layer structure with a high-quality coating on the front (ETFE), and fiberglass on the back, provides the best performance on the market regard to electrical performance (high transmissibility plastic with self-cleaning properties), mechanical resistance and corrosion resistance (ideal for boating).

With a TÜV certified junction box, UNISUN MF is protected against all cell overvoltage or hot spots(anti-spot protection) due to grey areas or cells getting masked, very common in boating (sailing boots etc...). Its streamlined shape minimises wind resistance and avoids ropes from getting stuck making it ideal for boating use.

Light and space-saving, UNISUN MF can be placed or fixed with rigging or bungee cords thanks to its integrated eyelets (diam.10).

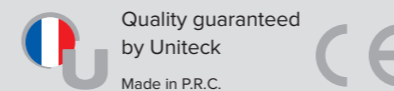

A MOUNTING BRACKET FOR EVERY USE

ADAPTED TO CAMPERVANS

The panel mounting bracket which simplifies mounting and maintenance

UNIFIX 1C is the innovative mounting bracket for fixing your panels on a flat surface. It sticks to the roof of your vehicle. To place it, UNIFIX 1C only requires 2 steps (clean and stick) instead of the usual 3 (clean, prepare and stick). Its compact design enables you to mount several panels, even on a surface filled with other components.

With its Easy Change system, you can easily replace or remove your panel for maintenance or cleaning.

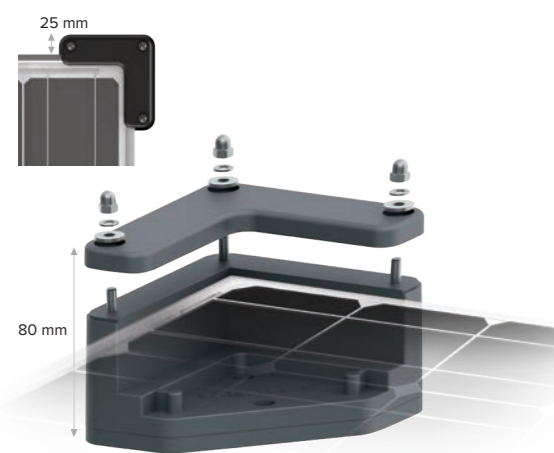

UNIFIX 1C
Included: 4 panel mounting brackets for 35 mm frame + sika degreaser + sika glue
Ref 0255



ADAPTED TO LEISURE

Basic range

Robust and simple to install, the basic UNIFIX is the economic mounting bracket, ideal to fix your panels on all flat surfaces (wall, concrete floor, timber frame.) Its tilting system allows for an optimized angle to have the best electrical performances. The 250B model can also be weighted to the ground, on a lawn or on sand.

UNIFIX 100B
560 mm panels max
for Unisun 20.12M(x2)/
20.24M(x2)/30.12M/50.12M/
55.12BC/80.12M/100.12M/
100.24M/110.12BC
Ref 0644

UNIFIX 150B
700 mm panels max
for Unisun 150.12M/BC
Ref 0545

UNIFIX 250B
1100 mm panels max
(=250 W)
can be weighted to the
ground
for Unisun 100.12M(x2)/
100.24M(x2)/110.12BC(x2)/
150.12M/150.12BC/200.24M
Ref 1092

can be weighted down



ADAPTED TO LEISURE

Universal range

Robust and easy to install, the universal UNIFIX is the ideal mounting bracket to fix your panels on all flat surfaces (wall, concrete floor, timber frame) or on round masts (diam. 40 to 60 mm).

Its tilting system enables an optimized angle for the best electrical production.

Universal, with its innovative design, the UNIFIX can be used on certain panels from other brands with different dimensions

UNIFIX 20
for Unisun 10.12M/10.24M/
20.12M/20.24M
Ref 0262

UNIFIX 50
for Unisun 30.12M/
50.12M/55.12BC
Ref 0279

UNIFIX 100
for Unisun 80.12M/
100.12M/110.12BC/100.24M
Ref 0316



UNIFIX 200
for Unisun 80.12M(x2)/100.
12M(x2)/100.24M(x2)/110.
12BC(x2)/150.12M(x1)/150.
12BC(x1)
Ref 0361

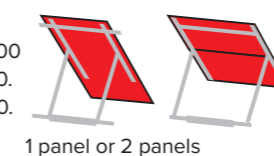

UNIFIX 300
for Unisun 80.12M(x3)/
100.12M(x3)/110.12BC(x3)/
100.24M(x3)/150.12M(x2)/
150.12BC(x2)
1 x 1200 mm
panel max (= 300W)
Ref 0378



UNITECK

- Easy Change system for maintenance or cleaning
- UV and corrosion resistant PA66 plastic+ fiberglass + stainless steel screws
- Compact
- Easy to install

UNITECK

- Corrosion resistant galvanised steel + stainless steel screws
- Easy to install
- Reclinable from 0 to 90° (except 250B: 30 to 60°)
- Wall mounting
- Floor mounting

UNITECK

- Corrosion resistant galvanised steel frame and screws
- Easy to install
- Reclinable from 0 to 90°
- Wall mounting
- Floor mounting
- Fixation on round masts Ø 40 to 60 mm (flanges included)

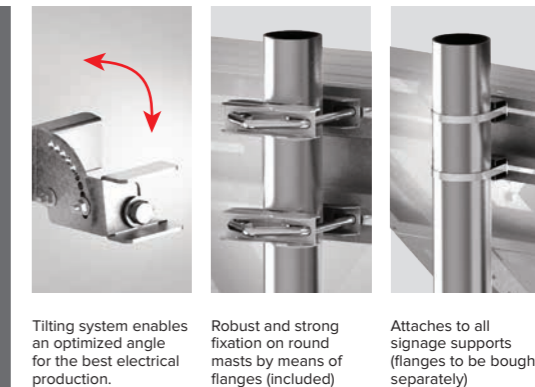



Designed made in France

Thanks to their universal fastening system, UNIFIX supports adapt to all signal masts. Simply slide your flanges with the M8 or M10 screws onto the rear rail and then tighten.

The SF range has a fixed 35° panel inclination, optimum for an all year round use. As for the S standard range, it offers the possibility to choose the inclination. The tilting system enables you to optimize the electrical production according to the area and the period of use.

With their Easy Install system (S range only) and their light aluminium structure, their mounting can easily be done alone, without extra assistance.

+ UNITECK



Adaptable on all signal masts



Corrosion resistant aluminium + A4 stainless steel screws



Easy to install



Can be fixed on any support



With flanges or U clamps (flanges and M8 or M10 screws not included)

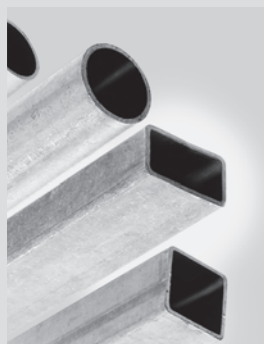

Can be fixed on any signal mast (flanges not included)



Can be fixed on the masthead or the middle of the mast (except UNIFIX 100SF, masthead only)

ADAPTED TO SIGNAGE

Fixed range



UNIFIX 20SF
for Unisun 10.12M/10.24M/20.12M/20.24M
Portrait orientation
Masthead and middle of the mast
Ref 1139



UNIFIX 100SF
for Unisun 30.12M/50.12M/55.12BC/80.12M/
100.12M/100.24M/110.12BC
Portrait orientation
Masthead
Ref 1146

ADAPTED TO SIGNAGE

Reclinable range

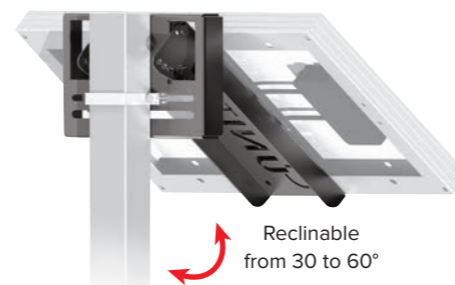

UNIFIX 20S
for Unisun 10.12M/10.24M/20.12M/20.24M
Landscape orientation
Masthead or middle of the mast
Ref 0286



UNIFIX 50S
for Unisun 30.12M/50.12M/55.12BC
Landscape orientation
Masthead or middle of the mast
Ref 0293

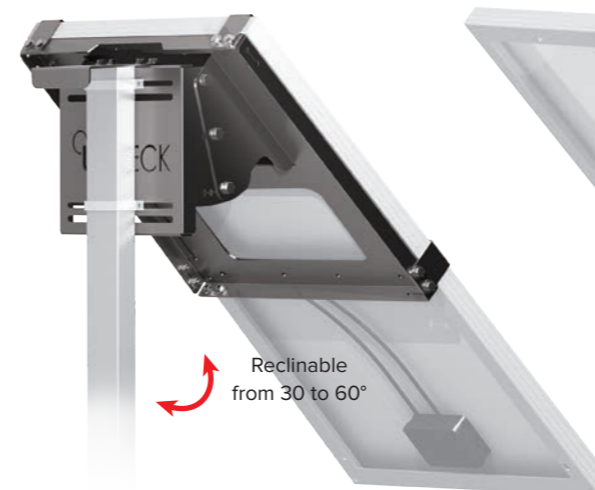

UNIFIX 100S
for Unisun 80.12M/100.12M/110.12BC
Landscape or portrait orientation
Masthead or middle of the mast
Ref 0323



UNIFIX 150S
for Unisun 150.12M/150.12BC
Landscape or portrait orientation
Masthead or middle of the mast
Ref 0866



Easy installation system

Its upper cap relieves the weight of the installation so that their mounting can easily be done alone, without extra assistance. This cap can be removed afterwards for a fixation on the middle of the mast (S versions only).

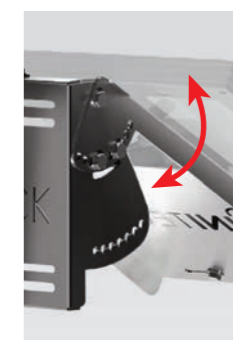

Light, innovative

Titling multi-position system to optimize your electrical performances



Designed made in France

ADAPTED TO BOATING

Pushpit mounting

The UNIFIX WB mounting brackets range is ideal to fix your rigid solar panels on your pushpit. Made of 316L polished stainless steel, they are robust and entirely protected against corrosion.

Thanks to their universal fixation system, the UNIFIX WB models can be fixed on all pushpits.

With an adjustable tilt for the 20.1WB and the 100.1WB, with adjustable tilt and steerable for the 50.2WB, the UNIFIX WB optimizes your electrical performance and thus increases your production up to 50% compared to an identical fixed installation.

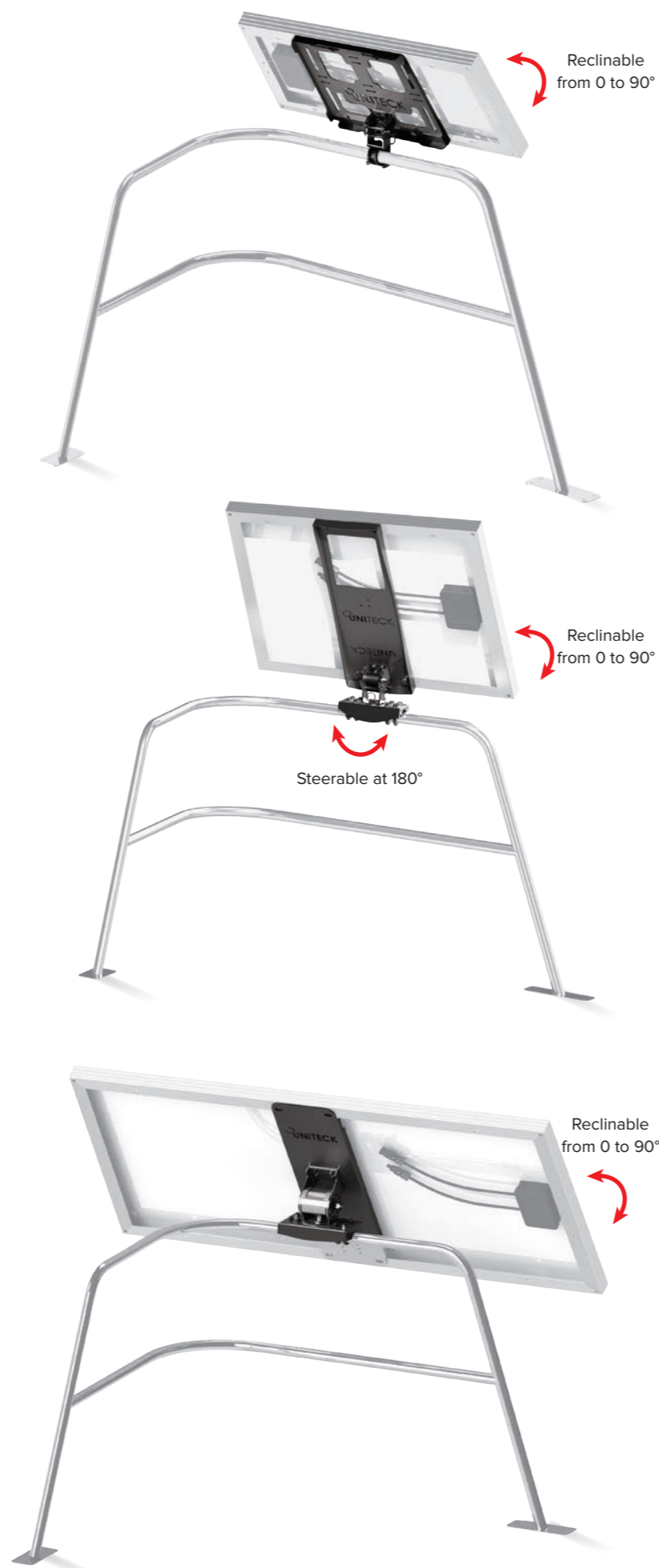

UNIFIX 20.1 WB
for Unisun
10.12M/10.24M/20.12M/20.24M
Ref 1009



UNIFIX 50.2 WB
for Unisun 30.12M/50.12M/55.12BC
Ref 1016



UNIFIX 100.1 WB
for Unisun 80.12M/100.12M/
100.24M/110.12BC
Ref 1153



Designed made in France

ADAPTED TO BOATING

arch mounting

The UNIFIX WP mounting brackets are ideal to fix your rigid solar panels on your arch. Made of SAE 316L polished stainless steel, they are robust and entirely protected against corrosion

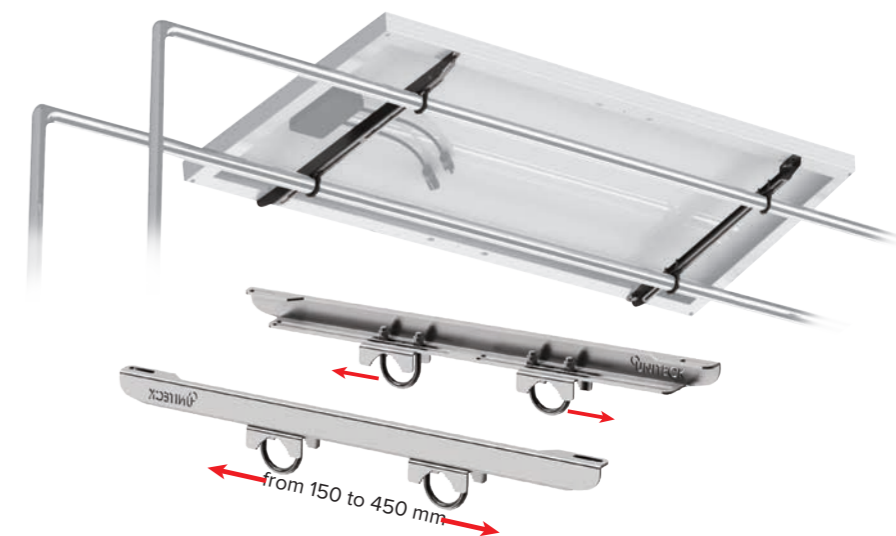

UNIFIX 100 WP
for Unisun 50.12M/55.12BC/80.12M/100.12M/100.24M/110.12BC
Ref 0859

UNIFIX 150 WP
for Unisun 150.12M/150.12BC
Ref 0514

UNIFIX 200 WP
for Unisun 200.24M
Ref 1450

UNITECK

Adaptable on all pushpits from Ø 22 to 28 mm

Corrosion resistant marine stainless steel

Easy to install

Reclinable from 0 to 90°

Steerable at 180°

UNITECK

Adaptable on all arches Ø 20 to 40 mm

Corrosion resistant marine stainless steel

Easy to install



Solar cables

Panel(s) > Charge controller



Unicable 651 BR - 5 m
2 × 5 m, 6 mm², black + red
Ref 1023

Unicable 681 BR - 8 m
2 × 8 m, 6 mm², black + red
Ref 0880

Unicable 6101 BR - 10 m
2 × 10 m, 6 mm², black + red
Ref 0897

Unicable 6151 BR - 15 m
2 × 15 m, 6 mm², black + red
Ref 0903

Parallel multi-panel option

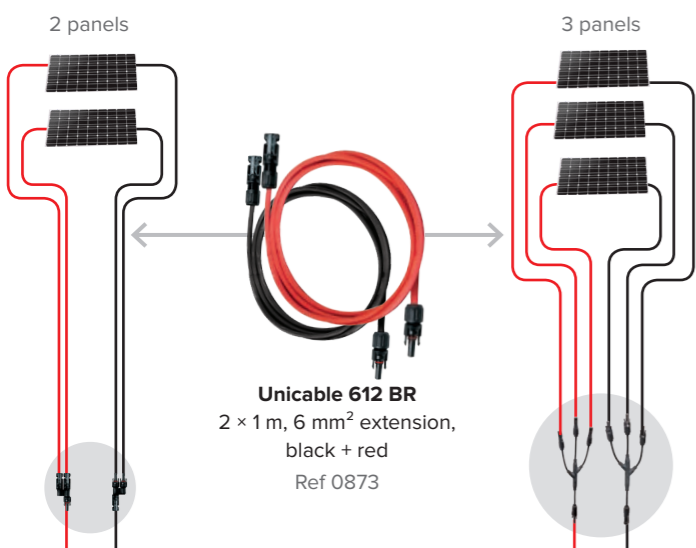

Unicable 612 BR
2 × 1 m, 6 mm² extension,
black + red
Ref 0873



**Parallel connectors kit
2 panels**
Ref 0231



**Parallel connectors kit
3 panels**
Ref 0163



Waterproof Roof-pass
Resistant to UV
(for 4-6 mm² cable)
Ref 0248



**Deck-pass/
bulkhead-pass**
resistant to UV with
quick solar connectors
Ref 1481



Sika Flex glue
professional multi-material
(aluminium, steel, plastic)
high performance. Ideal for
attaching camper supports,
deck-pass / roof-pass ...
300 ml, x1
Ref 1177



Degreaser/ activator
Sika to prepare
the surface before the glue
(metal, plastic, painted
surfaces). 1,5 ml x2
Ref 1184



Fast solar connectors kit
1 male + 1 female
(for 4-6 mm² cable)
Ref 0712



Reverse current protection
15 A anti-reverse current
diode inside. Connects on
the + connector of the panel
Ref 1702



**Caps for solar
connectors kit**
1 male + 1 female
Ref 0170



Solar cables

Charge controller > Battery/ Batteries



6.2M Battery connection kit
2 × 2 m of 6 mm² cables
+ 2 battery terminals
+ 1 fuse protection kit
Ref 0347

6.4M Battery connection kit
2 × 4 m of 6 mm² cable
+ 2 battery terminals
+ 1 fuse protection kit
Ref 0354

16.2 M Battery connection kit
2 × 2 m 16 mm² cable
+ 2 battery terminals
+ 1 fuse protection kit
Ref 1535



Unicable 6B100, black
6 mm², 100m coil
Ref 0774



Unicable 6R100, red
6 mm², 100m coil
Ref 0781



Battery terminals (+ and -)
Ref 1122



**Fuse protection kit
(fuse holder + fuse)**

	Max. power			Ref
	12V battery	24V battery	extra fuses (x3)	
Ref 0330	60 A/32 V	700 W	1400 W	Ref 1160
Ref 0217	80 A/32 V	950 W	1900 W	Ref 0187
Ref 0224	100 A/32 V	1200 W	2400 W	Ref 0194



	Max. power			Ref
	12V battery	24V battery	Extra fuses (x3)	
Ref 0385	125 A/32 V	1500 W	3000 W	Ref 1344
Ref 0392	150 A/32 V	1800 W	3600 W	Ref 1351
Ref 0439	200 A/32 V	2400 W	4800 W	Ref 1368
Ref 0606	250 A/32 V	3000 W	6000 W	Ref 1375

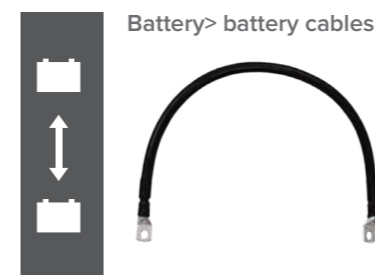

Battery > battery cables

	cross section	length	12V battery fleet		24V battery fleet	
			max. current/ max. power	voltage drop/loss of electrical power	max. current/ max. power	voltage drop/loss of electrical power
Ref 1658	25 mm ²	40 cm	80 A/1000 W	0,06 V/5 W	160 A/4000 W	0,12 V/20 W
Ref 1665	35 mm ²	40 cm	124 A/1500 W	0,06 V/8 W	250 A/6000 W	0,12 V/30 W
Ref 1672	50 mm ²	40 cm	160 A/2000 W	0,06 V/10 W	320 A/8000 W	0,12 V/40 W
Ref 1689	70 mm ²	40 cm	250 A/3000 W	0,06 V/15 W	500 A/12000 W	0,12 V/60 W
Ref 1696	95 mm ²	40 cm	340 A/4000 W	0,06 V/20 W	680 A/16000 W	0,12 V/80 W

Section = copper resistivity (= 0.21) × back and forth length × max current × current × acceptable voltage drop (0.5% for optimum load)

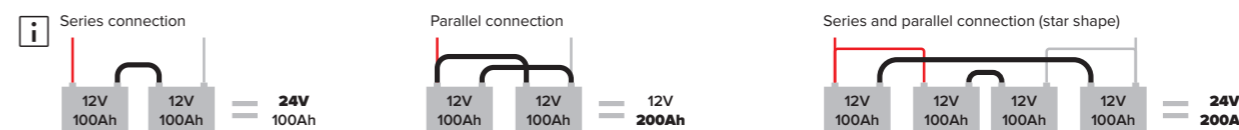

ONE PANEL CONNECTION KIT

Ready to use connection kits.

They are easily and quickly connected to the panels and the regulator via their quick solar connectors. With a 6 mm² section, they optimize your electrical performance.

They are equipped with a fuse kit to protect your installation and your battery, a UV-resistant waterproof roof-pass (Uniconnect 1.6) or cable glands (Uniconnect Signs) and battery terminals

Leisure/ boating/ campervans



UNICONNECT 1.6

Included:
• Panel > regulator connection: 2 × 8 m cable, 6 mm² with connectors + waterproof roof-pass
• Regulator > Battery connection: 2 × 2 m cable + battery terminals + fuse protection kit

Ref 0200

Signage



UNICONNECT SIGNS

Included:
• Panel > regulator connection: 2 × 3 m cable, 6 mm² with connectors + cable glands
• Regulator > battery connexion: 2 × 1 m cable + battery terminals + fuse protection kit

Ref 0811

PMW CHARGING TECHNOLOGY

* Pulse Width Modulation

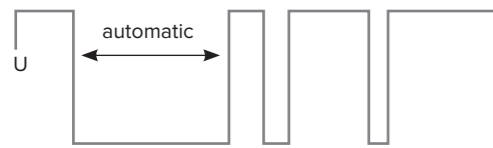

- Charges by modulating current pulses.
- Recharges faster (than an ON/OFF charge controller).
- Reduces internal battery heating.
- Lowers the panel voltage to the charging voltage of the battery

EASIER CABLING AND MOUNTING

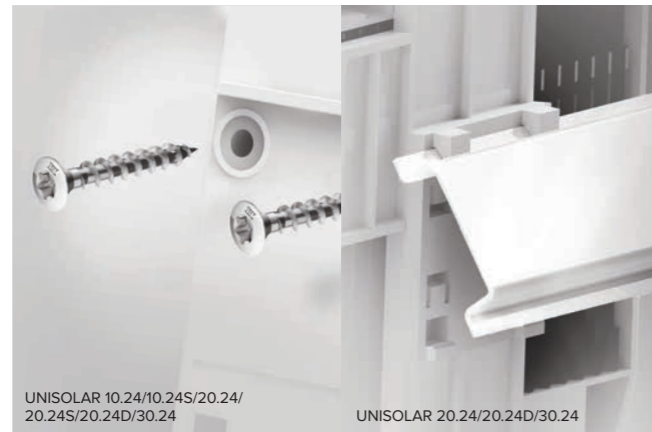

UNISOLAR 10.24/10.24S/20.24/
20.24S/20.24D/30.24

UNISOLAR 20.24/20.24D/30.24

Wall and/or DIN rail mount

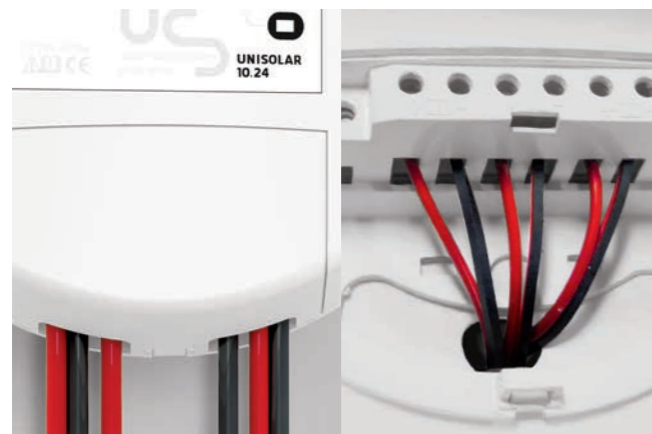

Normal wiring or through a partition wall



CHARGING CURVE UNIQUE ON THE MARKET

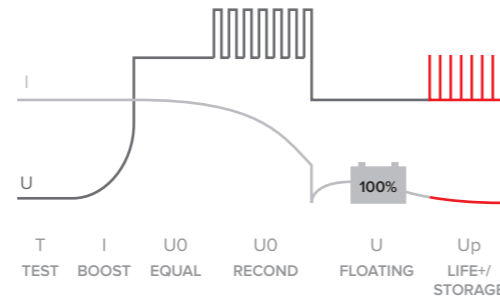

1 Test



Analysis of the battery's status.

2 Boost charge



Fast charge at maximum power

3 Equalisation



Equalization of the charge to 100% on all the elements of the battery.

4 Recondition



Battery stirring to prevent stratification. Electrolyte mixing of the battery to avoid all sulfation and stratification

5 100%



Maintaining the charge at 100% (floating).

6 Life+/Storage



Compensation of the natural self-discharge of the battery, with pulse charge for more battery life.

The chemical properties of the battery change according to the ambient temperature. With its external incorporated temperature sensor, UNISOLAR regulates its end of-charge voltage, related to a reference temperature of 25°C, with +/- 30mV per °C. Without any regulation, the battery is either under loaded, limiting the electrical autonomy, or overloaded, irreversibly damaging its lifespan.



Tests, charges at 100%, avoids sulfation and stratification, maintains the charge and improves the battery life.



Charges all lead-acid batteries thanks to its regulation adapted to every type of battery.



Regulates the voltage according to the ambient temperature, to avoid over- or under-charging.



Protects against surges, overconsumption, short circuits, polarity reversals, low battery



100% made in France (design, electronic card, mechanics...)

PWM UNISOLAR: Solar Charge controllers

A CONCENTRATE OF TECHNOLOGY

The Unisolar range revolutionizes the charge controller market.

UNISOLAR controllers incorporate a unique 6-step charging algorithm, Algotek 6, which tests your battery, charges it at 100%, desulfates it, delaminates it, maintains its charge and improves its lifetime while taking into account the ambient temperature to adjust its voltage thresholds according to the recommendations of the battery manufacturers (integrated temperature sensor).

With its unique and innovative design, and its possible wiring through walls, UNISOLAR perfectly integrates into the passenger compartment of your vehicle or in your residence.

Its intuitive interface enables an easy access to necessary information in order to optimize the charge and your power consumption.

Its mechanical conception provides a high level of protection, preserving the electronics against dust.



Designed,
made
in France

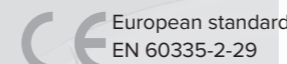

European standard
EN 60335-2-29

	UNISOLAR 10.24 & 10.24S	UNISOLAR 20.24 & 20.24S	UNISOLAR 20.24D	UNISOLAR 30.24
	Ref 0002 & 0958	Ref 0019 & 0576	Ref 0026	Ref 0965
System				
Battery voltage	12/24 V	12/24 V	12/24 V	12/24 V
Max. charging current	10 A	20 A	20 A	30 A
Self-consumption	4 mA	4 mA	4 mA (RM=20mA)	4 mA
Compatible panel				
Recommended voltage (for 12V Battery) - Vmp	17-19 V	17-19 V	17-19 V	17-19 V
Recommended voltage (for 24V Battery) - Vmp	34-38 V	34-38 V	34-38 V	34-38 V
Max. power (for 12V Battery)	150 W	300 W	300 W	450 W
Max. power (for 24V Battery)	300 W	600 W	600 W	900 W
Technology	PWM	PWM	PWM	PWM
Battery charge controller				
Algorithm	Algoteck 6	Algoteck 6	Algoteck 6	Algoteck 6
Voltage selection	auto	auto	auto	auto
Battery type selection	yes	yes	yes	yes
Recommended battery capacity	10 > 150 Ah	10 > 300 Ah	10 > 300 Ah	10 > 450 Ah
Temperature compensation	yes	yes	yes	yes
Panel surge protection	yes	yes	yes	yes
Output controller 12/24V*	Model 10,24 only	Model 20,24 Only		
Output current	1-10 A	1-20 A		1-30 A
Output voltage 12 or 24V (depending on battery)	yes	yes		yes
Overconsumption protection	yes	yes		yes
Low battery protection	yes	yes		yes
Mechanical characteristics				
Max. cable cross section	6 mm ²	6 mm ²	6 mm ²	10 mm ²
International Protection rating	IP43	IP43	IP43	IP43
Operating temperature	-35 °C > +55 °C	-35 °C > +55 °C	-35 °C > +55 °C	-35 °C > +55 °C
Storage temperature	-35 °C > +80 °C	-35 °C > +80 °C	-35 °C > +80 °C	-35 °C > +80 °C
Dimensions (w x h x d) without DIN rail (mm)	120 × 110 × 42	20.24 : 127×150×55 20.24S : 120×110×42	137 × 150 × 46,5	127 × 150 × 55
Weight	200 g	20.24 : 350 g 20.24S : 200 g	350 g	400 g

* Equipped with an output controller, UNISOLAR directly supplies your 12 or 24 V electrical devices (depending on the connected battery). UNISOLAR protects your battery against deep discharges of the battery thanks to a low battery voltage cut, with automatic recovery of the power supply when the battery charge level is sufficient.

PWM UNISOLAR CHARGE CONTROLLER

ONE BATTERY



UNISOLAR 10.24



One battery
10 A - 12/24 V
12/24 V output controller
Max Panel power:
150 W (☐ 12 V)
300 W (☐ 24 V)
Ref 0002



UNISOLAR 10.24S



One battery
10 A - 12/24 V
Max Panel power:
150 W (☐ 12 V)
300 W (☐ 24 V)
Ref 0958



UNISOLAR 20.24



One battery
20 A - 12/24 V
12/24 V output controller
Max Panel power:
300 W (☐ 12 V)
600 W (☐ 24 V)
Ref 0019



UNISOLAR 20.24S



One battery
20 A - 12/24 V
Max Panel power:
300 W (☐ 12 V)
600 W (☐ 24 V)
Ref 0576



UNISOLAR 30.24



One battery
30 A - 12/24 V
12/24 V output controller
Max Panel power:
450 W (☐ 12 V)
900 W (☐ 24 V)
Ref 0965

TWO BATTERIES



UNISOLAR 20.24 D



Two batteries
20 A - 12/24 V
12/24 V output controller
Max Panel power:
300 W (☐ 12 V)
600 W (☐ 24 V)
Ref 0026



UNISOLAR RM
Remote display
for Unisolar 20.24D

Wall mounted or embedded
into wall

Enables complete control
and configuration:
• Batteries 1 and 2 : current
voltage, min., max., injected
capacity
• Panel: voltage, instant
current, max. current,
injected capacity in Ah,
frequency, priority (battery 1,
battery 2)
• Temperature/time



W x H x D =
110 × 120 × 53 mm
300g
RJ45 - 8 m cable
Ref 0033

**UNISOLAR 20.24D + RM =
UNISOLAR 20.24 DR**
Ref 0040

CHARGING CURVE UNIQUE ON THE MARKET

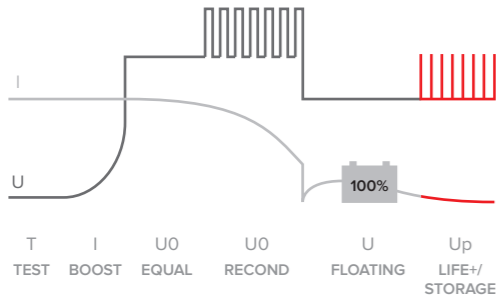

- 1 Test**
Analysis of the battery's status.
- 2 Boost charge**
Fast charge at maximum power
- 3 Equalisation**
Equalization of the charge to 100% on all the elements of the battery.
- 4 Recondition**
Battery stirring to prevent stratification. Electrolyte mixing of the battery to avoid all sulfation and stratification
- 5 100%**
Maintaining the charge at 100% (floating).
- 6 Life+/Storage**
Compensation of the natural self-discharge of the battery, with pulse charge for more battery life.

Designed, made in France

European standard EN 60335-2-29

PERFECT CHARGE ADAPTED TO BATTERY'S TECHNOLOGY

Voltage thresholds

Gel battery	AGM battery	Flooded battery
Boost		
14,2 V	14,4 V	14,5 V
Absorption		
-	14,4 V	14,5 V
Leveling		
-	-	14,8 V
Floating		
13,9 V	13,9 V	13,9 V

Algoteck adjusts the levels according to the internal analysis of the battery and the ambient temperature.

PERFECT CHARGE ADAPTED TO AMBIENT TEMPERATURE

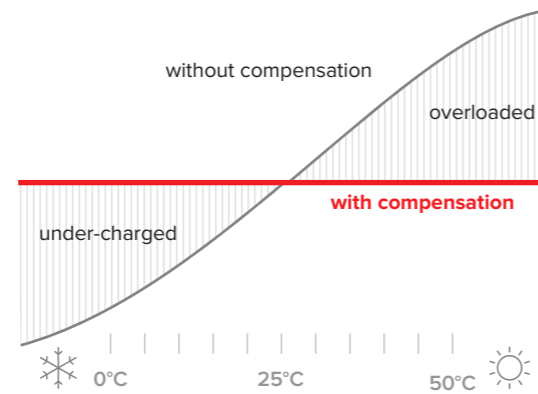

The chemical characteristics of the battery vary according to the ambient temperature. Thanks to its temperature sensor, UNIMPPT regulates all its voltage thresholds, compared to a reference temperature of 25 °C of +/- 30mV per °C. Without regulation, the battery is either under-charged, limiting the electric autonomy, or overloaded, irreversibly degrading its life.

UNIMPPT SOLAR CHARGE CONTROLLER

EVOLVED ELECTRONICS



- Evolved MPPT Technology
- Tests, charges at 100%, avoids sulfation and stratification, maintains the charge and improves the battery life.
- Charges all batteries thanks to its regulation adapted to every type of battery.
- Regulates the voltage according to the ambient temperature, to avoid over- or under-charging.
- Protects against surges, overconsumption, short circuits, polarity reversals, low battery
- 100% made in France (design, electronic card, mechanics...)

The MPPT range is revolutionizing the charge controllers market.

Its ALGOTECK 6 charging curve, the only one of its kind on the market, tests your battery, recharges it a 100%, desulfates it, delaminates it, maintains its charge and improves its lifespan, while taking into consideration the technology and the ambient temperature of your battery to adjust its voltage levels according to the recommendations of the battery manufacturers.

With its MPPT technology (inverter solar charge controllers), UNIMPPT uses all the panel voltage by reconverting the surplus of panel/battery voltage, not used with a standard charge controller, in charge intensity for the battery.

Its optimized MPPT program, paired up with one of the fastest microprocessors on the market, searches in real-time (every 100ms), the maximum power point of the panel.

UNIMPPT guarantees up to 40% more energy in the winter and 15% more energy in the summer compared to a PWM charge controller, even under charging weather conditions.

Its unique and innovative design with wiring through partition walls enables a perfect and discreet integration into your home or the passenger compartment of your car.

EASIER CABLING AND MOUNTING

UNIMPPT 30/10.12S, 60/15.24, 60/15.24S, 60/20.24S, 60/30.24S, 60/40.24 S, 100/60.24S



Wall mount

UNIMPPT 30/10.12S, 60/15.24, 60/15.24S, 60/20.24S

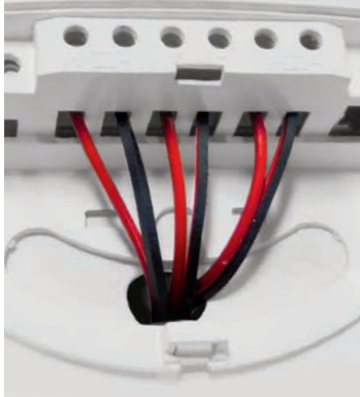

Wiring through a partition wall

UNIMPPT 30/10.12S, 60/15.24, 60/15.24S, 60/20.24S



UNIMPPT 60/30.24S, 60/40.24 S, 100/60.24S



Normal wiring

ADVANCED CONCEPTION

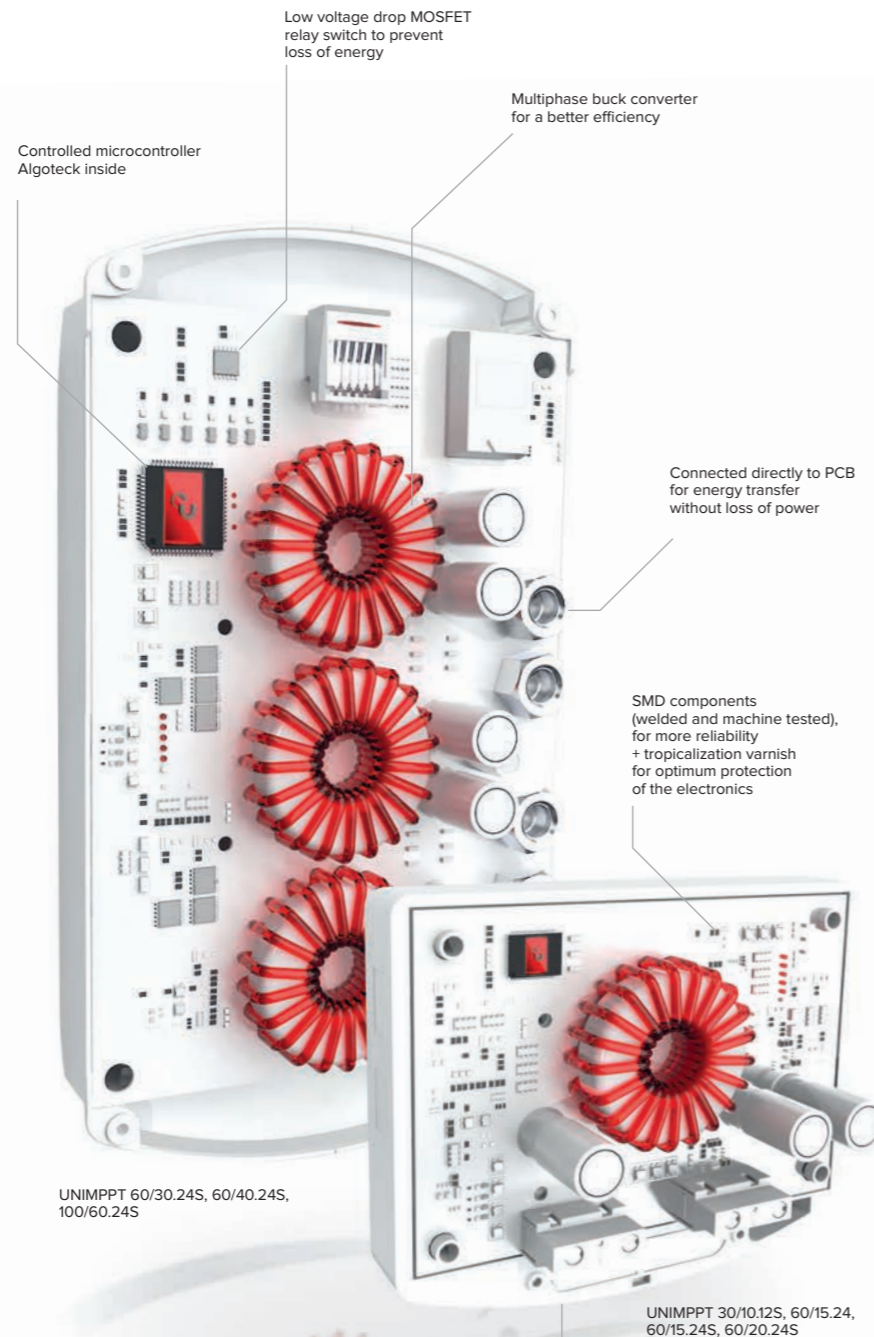

designed, made in France

Entry-level price range	UNIMPPT
Output at 20W	95% 98%
Output at 50W	90-95% 98%
Output at max. capacity	< 90% 98%

mppt
TECHNOLOGY

Maximum Power Point Tracking

MPPT VS PWM 20 TO 40% MORE ENERGY

Unlike a PWM regulator, that lowers the panel's voltage to the battery's voltage, an MPPT (inverter charge controller) uses all of the panel's voltage by reconvertng the voltage surplus of panel/battery voltage not used by the battery into charging current (amperes).

Winter simulation	
Solar panel 100 W	
Panel voltage : 19 V	
Panel current : 5 A	
Controller	
PWM	MPPT
Output voltage	
↘ 12.5 V	↘ 12.5 V
Output current	
→ 5 A	↗ 8 A
Battery	
67 W	95 W (+ 40%)

In summer, the panel voltage decreases with the ambient temperature (average V: 16-17 V), the average gain of a MPPT compared to a PWM is 20%.

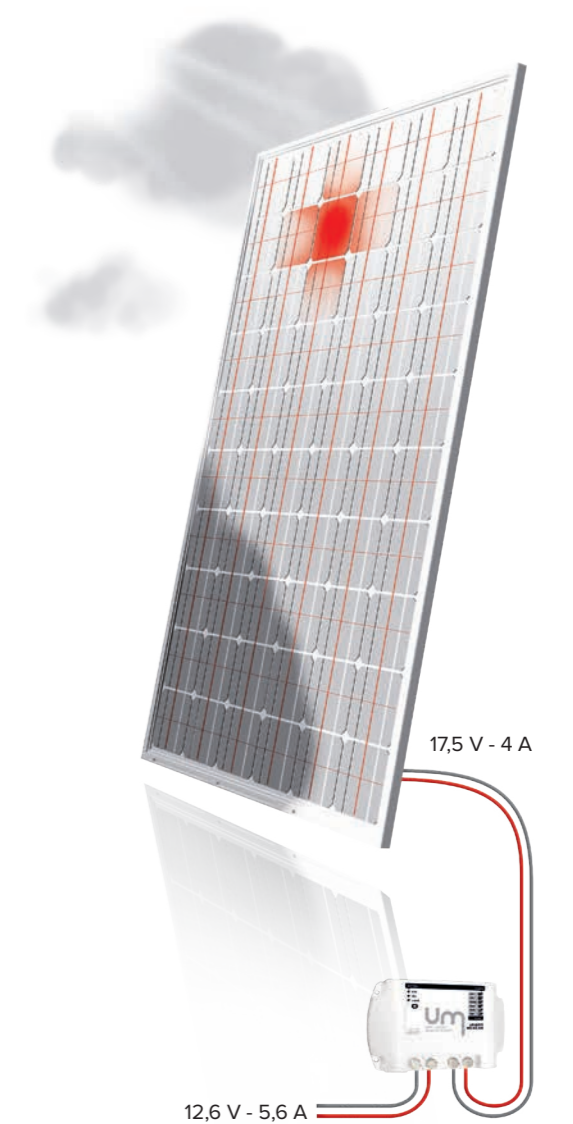

UNIMPPT FAST TRACK

Due to clouds and shadows, the light intensity changes rapidly. Thanks to its Fast Track MPPT program and its ultra fast microprocessor, UNIMPPT searches for the maximum power point of the solar panel and then modifies in real time its conversion parameters (input / output) for maximum power.

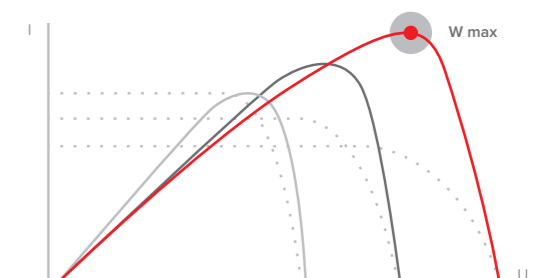

		UNIMPPT 30/10.12S	UNIMPPT 60/15.24 & 60/15.24S	UNIMPPT 60/20.24S	UNIMPPT 60/30.24S	UNIMPPT 60/40.24 S	UNIMPPT 100/60.24S
		Ref 0989	Ref 0934 & 0972	Ref 1726	Ref 1733	Ref 1467	Ref 1474
System							
Battery voltage		12 V	12/24 V	12/24 V	12/24 V	12/24 V	12/24 V
Max. charging current		10 A	15 A	20 A	30 A	40 A	60 A
Self-consumption		10 mA	10 mA	10 mA	10 mA	10 mA	10 mA
Compatible panel							
Min-max intensity (Voc)	with 12V battery	17-30 V	17-60 V	17-60 V	17-60V	17-60V	17-100V
	with 24V battery	N/A	34-60 V	34-60 V	34-60 V	34-60 V	34-100 V
Max. power	with 12V battery	150 W	250 W	300 W	450 W	600 W	900 W
	with 24V battery	N/A	500 W	600 W	900 W	1200 W	1800 W
Technology							
		MPPT	MPPT	MPPT	MPPT	MPPT	MPPT
Efficiency		98,00%	98,00%	98,00%	98,00%	98,00%	98,00%
Battery charge controller							
Algorithm		Algoteck 6	Algoteck 6	Algoteck 6	Algoteck 6	Algoteck 6	Algoteck 6
Voltage selection		N/A	auto	auto	auto	auto	auto
Battery type selection (Gel/ Agm/ Liquid)		yes	yes	yes	yes	yes	yes
Recommended battery capacity		10 > 200 Ah	10 > 300 Ah	10 > 300 Ah	10 > 300 Ah	50 > 800 Ah	50 > 1200 Ah
Temperature compensation							
via integrated sensor (temperature)		yes	yes	yes	no	no	no
via remote sensor (voltage + temperature)/ optional		no	no	no	optional	optional	optional
Panel surge protection		yes	yes	yes	yes	yes	yes
Output controller 12/24V**							
Output current			model 60/15.24 Only 15 A DC, 40 A max				
Output voltage 12 or 24V (depending on battery)			yes				
Overconsumption protection			yes				
Low battery protection			yes				
Mechanical characteristics							
Max. cable cross section		6 mm ²	6 mm ²	6 mm ²	35 mm ²	35 mm ²	35 mm ²
International Protection rating		IP32	IP32	IP32	IP32	IP32	IP32
Operating temperature		-20° > +60°C	-20° > +60°C	-20° > +60°C	-20° > +60°C	-20° > +60°C	-20° > +60°C
Storage temperature		-35°C > +80°C	-35°C > +80°C	-35°C > +80°C	-35°C > +80°C	-35°C > +80°C	-35°C > +80°C
Dimensions (w x h x d) without DIN rail (mm)		120 x 110x45	137 x 150 x 47	137 x 150 x 47	127 x 150x55	127 x 86 x 53	127 x 86 x 53
Weight		300 g	350 g	350 g	1 kg	1,1 kg	1,3 kg

* Equipped with an output controller, UNIMPPT directly supplies your 12 or 24 V electrical devices (depending on the connected battery). UNIMPPT protects your battery against deep discharges of the battery thanks to a low battery voltage cut, with automatic recovery of the power supply when the battery charge level is sufficient.

Charge controller MPPT UNIMPPT



UNIMPPT 30/10.12S

 10 A-12 V
 Max. panel power
 150 W - 30 Voc (☑ 12 V)
 Ref 0989



UNIMPPT 60/30.24S

 30 A-12/24 V
 Max. panel power
 450 W - 60 Voc (☑ 12 V)
 900 W - 60 Voc (☑ 24 V)
 Ref 1733



UNIMPPT 60/15.24

 15 A-12/24 V
 12/24 V output controller
 Max. panel power
 250 W - 60 Voc (☑ 12 V)
 500 W - 60 Voc (☑ 24 V)
 Ref 0934



UNIMPPT 60/40.24S

 40 A-12/24 V
 Max. panel power
 600 W - 60 Voc (☑ 12 V)
 1200 W - 60 Voc (☑ 24 V)
 Ref 1467



UNIMPPT 60/15.24S

 15 A-12/24 V
 Max. panel power
 250 W - 60 Voc (☑ 12 V)
 500 W - 60 Voc (☑ 24 V)
 Ref 0972



UNIMPPT 100/60.24S

 60 A-12/24 V
 Max. panel power
 900 W - 100 Voc (☑ 12 V)
 1800 W - 100 Voc (☑ 24 V)
 Ref 1474



UNIMPPT 60/20.24S

 20 A-12/24 V
 Max. panel power
 300 W - 60 Voc (☑ 12 V)
 600 W - 60 Voc (☑ 24 V)
 Ref 1726



UNISENSOR
 Remote sensor: measures voltage and temperature directly at the battery's terminal for a more accurate charge.
 RJ45 cable (3m). W x H x D = 55 x 40 x 30 mm. 30g.
 For UNIMPPT 60/30.24S, 60/40.24S, 100/60.24S.
 Ref 0408



	UNIBAT 80.12 AGM	UNIBAT 100.12 AGM	UNIBAT 150.12 AGM	UNIBAT 220.12 AGM
Ref 1573	Ref 1580	Ref 1597	Ref 1603	

System

	UNIBAT 80.12 AGM	UNIBAT 100.12 AGM	UNIBAT 150.12 AGM	UNIBAT 220.12 AGM
Battery voltage	12 V	12 V	12 V	12 V
Nominal capacity 20 h (C20)	80 Ah	100 Ah	150 Ah	220 Ah
Temperature characteristics		30°C : 105% 25°C : 103% 10°C : 95% -10°C : 78%		
Self-discharge (25°)		1 month : 3% 3 months : 8% 6 months : 15 %		
Internal resistance (25°C)	< 5,8 mΩ	< 5 mΩ	< 3,1 mΩ	< 2,5 mΩ

Performances

	UNIBAT 80.12 AGM	UNIBAT 100.12 AGM	UNIBAT 150.12 AGM	UNIBAT 220.12 AGM
Nominal capacity	20 h (C20) 80 Ah	100 Ah	150 Ah	220 Ah
	10 h (C10) 74 Ah	95 Ah	143 Ah	205 Ah
	5 h (C5) 67 Ah	87 Ah	131 Ah	194 Ah
	1 h (C1) 43 Ah	64 Ah	98 Ah	144 Ah
Cycles (% of discharge)	20%	2000 > 2500		
	50%	900 > 1000		
	80%	600 > 650		
	100%	350 > 400		
Maximum charging current	32 A	40 A	57 A	82 A
Maximum discharge current	0,1 s 1600 A	1900 A	2860 A	4100 A
	5 s 640 A	760 A	1144 A	1640 A
	continuous 240 A	285 A	430 A	615 A

Mechanical characteristics

Connector technology	M8 copper nickel-silver plated brass insert
Shape of plates	flat
Plate material	pure lead at 99,9%
Separator	AGM (Absorptive Glass Mat)
Electrolyte	absorbed
Case Material	high-strength polypropylene
Operating temperature	-15 > +40°C

Dimensions (w x h x d)	368 x 219 x 172 mm	368 x 219 x 172 mm	522 x 221 x 240 mm	522 x 221 x 240 mm
Weight	27 kg	29,5 kg	43,5 kg	58,5 kg



1,5 TO 2 X MORE CYCLES*

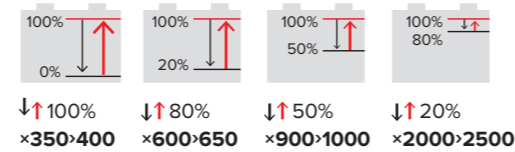

UP TO 2 X LONGER LIFETIME*

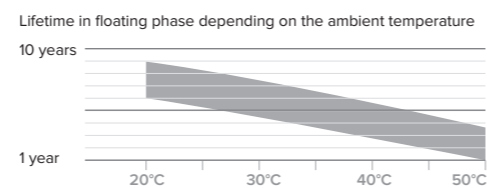

FLOODED BATTERY VS AGM

Flooded battery	AGM Battery
Strength	
-	+++ better circulations of the ions/ less internal resistance
Charging/discharging speed	
-	+++ better circulations of the ions/ less internal resistance
Load resistance	
- higher self-discharge	+++ lower self-discharge
Deep discharge	
---	++ possible up to 80% with imperative charging afterwards
Heath emission	
strong	weak less internal resistance
Storing	
- needs a well ventilated area (Hydrogen release)	+++ very weak hydrogen release
Transportation	
--- risky (risk of leaks)	++ electrolyte absorbed by the glass mat
Resistance to shocks and vibrations	
- more fragile	+++ tightly fixed compressed sheets
Resistance to cold	
- risk of freezing	+++ no liquids

* compared to most AGM batteries on the market



AGM Sealed battery for maximum security

Higher charge/ discharge cycling capacity compared to other AGM batteries on the market x 2

High discharge rates (imperative recharging afterwards)

Longer lifespan than other AGM batteries x 2

Low self-discharge

Advanced technological design (pure lead, carbon additive, machine pressed high density grid)

AGM batteries UNIBAT

HIGH EFFICIENCY

Equipped with an advanced technological design (compressed high density pure lead grid, highly absorbent glass mat, carbon additive ...) UNIBAT AGM batteries perform up to 2 times better in cycling and lifespan than most batteries of the same category on the market.

Thanks to their unique internal design, UNIBAT AGM batteries can accept discharge rates of up to 80% to make the most of the available energy. Their weak self-discharge guarantees a good stability over time.

Its AGM technology guarantees safe use without leaks or gas release.

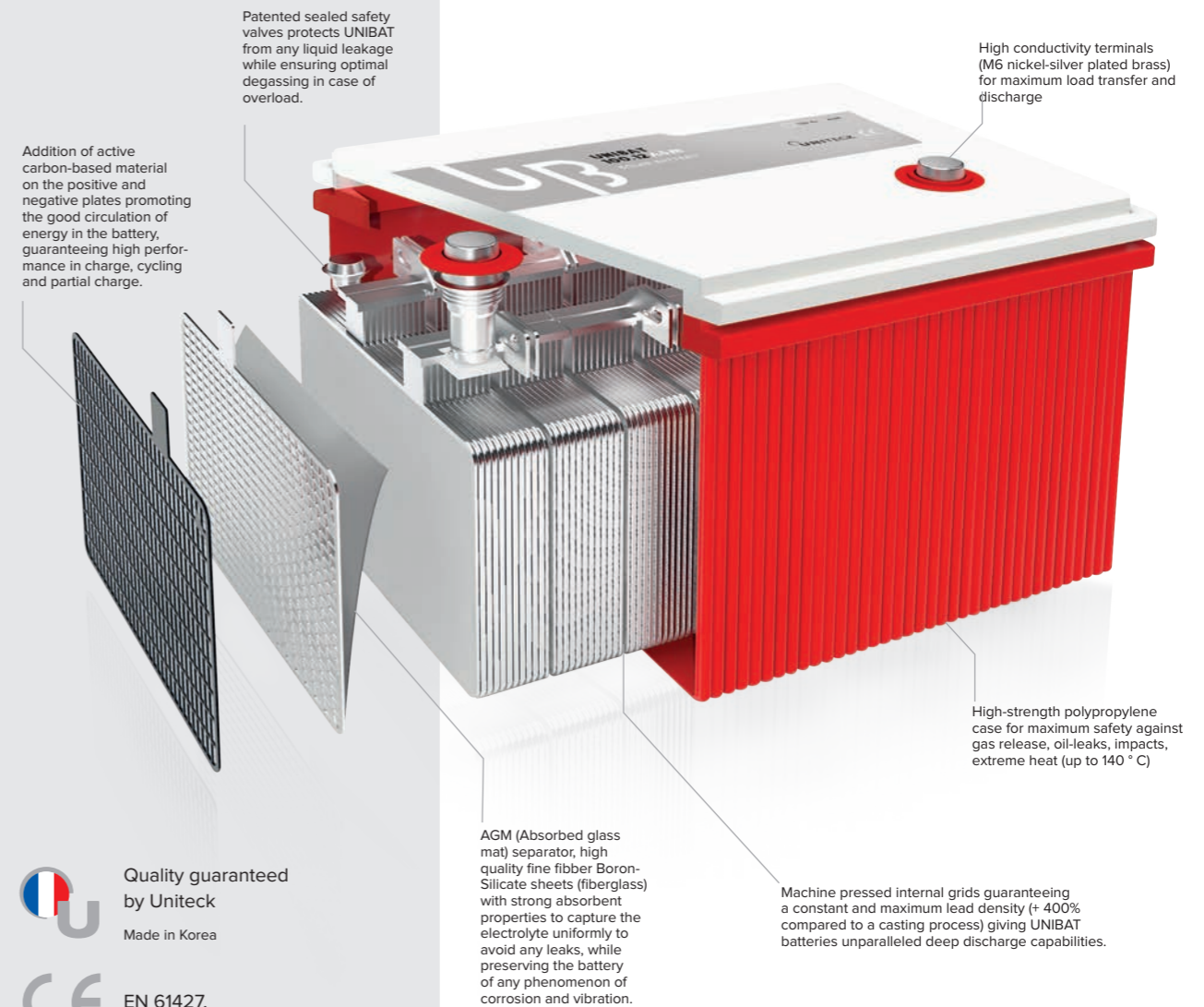

Quality guaranteed by Uniteck
Made in Korea

CE EN 61427, EN 60896-21, EN 60896-22



	UNIBAT 80.12 GEL	UNIBAT 100.12 GEL	UNIBAT 150.12 GEL	UNIBAT 220.12 GEL
	Ref 1610	Ref 1627	Ref 1634	Ref 1641

System

	UNIBAT 80.12 GEL	UNIBAT 100.12 GEL	UNIBAT 150.12 GEL	UNIBAT 220.12 GEL
Battery voltage	12 V	12 V	12 V	12 V
Nominal capacity 20 h (C20)	80 Ah	100 Ah	150 Ah	220 Ah
Temperature characteristics		30°C : 105% 25°C : 103% 10°C : 95% -10°C : 78%		
Self-discharge (25°)		1 month : 3% 3 months : 8% 6 months : 15%		
Internal resistance (25°C)	< 5,8 mΩ	< 5 mΩ	< 3,1 mΩ	< 2,5 mΩ

Performances

	20 h (C20)	80 Ah	100 Ah	150 Ah	220 Ah
Nominal capacity	10 h (C10)	74 Ah	95 Ah	143 Ah	200 Ah
	5 h (C5)	70 Ah	87 Ah	131 Ah	191 Ah
	1 h (C1)	56 Ah	64 Ah	99 Ah	135 Ah
	Cycles (% of discharge)		3000 > 3500	1500 > 1750	800 > 900
Maximum charging current	20 A	25 A	37,5 A	55 A	
	0,1 s	1600 A	1900 A	2860 A	4000 A
Maximum discharge current	5 s	640 A	760 A	1140 A	1600 A
	continuous	240 A	285 A	430 A	600 A

Mechanical characteristics

Connector technology	M8 copper nickel-silver plated brass insert			
Shape of plates	flat			
Case material	high-strength polypropylene plastic			
Electrolyte	jellified			
Material of plates	pure lead at 99,9%			
Operating temperature	-20 > +50°C			
Dimensions (w x h x d)	368 x 219 x 172 mm	368 x 219 x 172 mm	522 x 221 x 240 mm	522 x 221 x 240 mm
Weight	27,5 kg	30 kg	45 kg	59 kg



1,5 TO 2 X MORE CYCLES*

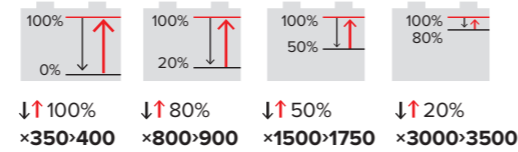

UP TO 2 X LONGER LIFETIME*

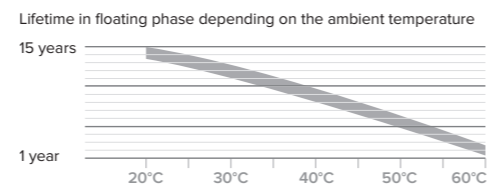

FLOODED BATTERY VS GEL

Flooded battery	UNIBAT GEL Battery
Strength	
-	++ better circulations of the ions/ less internal resistance
Charging/ discharging speed	
-	++ better circulations of the ions/ less internal resistance
Load resistance	
higher self- discharge	+++ weak self-discharge
Deep Discharge	
---	+++ can handle very deep discharges 100% with imperative charging afterwards
Maintenance	
water level to be checked and refilled regularly	+++ recombining gas technology that avoids any loss of water
Heat emission	
Strong	Weak less internal resistance
Storing	
needs a well ventilated area (Hydrogen release)	+++ very weak hydrogen release
Gas release	
high	weak in case of overload.
Transportation	
risky (risk of leaks)	+++ jellified Electrolyte
resistance to shocks and vibrations	
more fragile	+++ tightly fixed compressed sheets
Resistance to cold	
risk of freezing	+++ no liquids

* compared to most GEL batteries on the market



GEL Sealed battery for maximum security

Higher charge/ discharge cycling capacity compared to other GEL batteries on the market
x 2

High discharge rates (imperative recharging afterwards)

Longer lifespan than other GEL batteries
x 2

Low self-discharge

Advanced technological design (pure lead, carbon additive, machine pressed high density grid)

GEL batteries UNIBAT

HIGH EFFICIENCY

Equipped with an advanced technological design (compressed high density pure lead grid, pure silica jellified, carbon additive ...) UNIBAT GEL batteries perform up to 2 times better in cycling and lifespan than most batteries of the same category on the market.

Thanks to their unique internal design, UNIBAT GEL batteries can accept discharge rates of up to 100% to make the most of the available energy. Their weak self-discharge guarantees a stability over time.

Its GEL technology guarantees safe use without leaks or gas release.

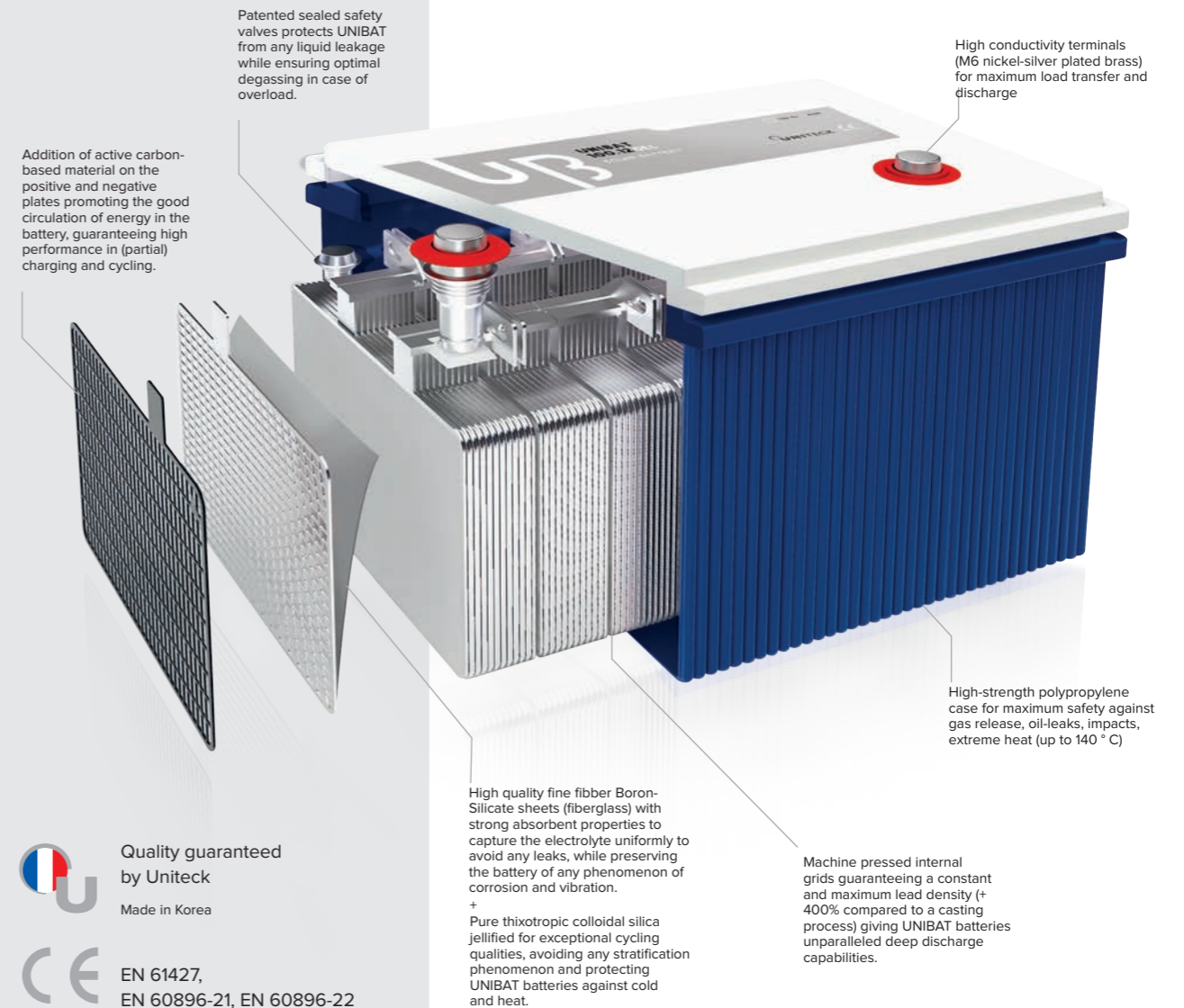

Quality guaranteed by Uniteck

Made in Korea

CE EN 61427, EN 60896-21, EN 60896-22



ADVANCED ELECTRONIC ARCHITECTURE

+ efficiency
- selfconsumption
= more energy

ex: of a quasi sinus	Other (entry level price range)	UNIPOWER
conversion rate	80-85%	87%
self-consumption/ hour	0,4-0,5 Ah	0,25 Ah

Simulation of a 100 Ah battery		
Converted energy	85 Ah	87 Ah
self-consumption over 24h	10 Ah	5 Ah
restored energy	75 Ah	82 Ah

10% to 20%*

more energy

*If maximum discharge is set at 50%



Advanced electronic architecture

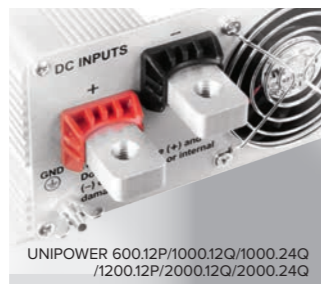

Robust mechanics



Powerful USB Socket



Remote display and control

THE 12 V>230 V/24 V>230 V RANGE



To supply your 230V electrical devices with your 12V or 24V battery.

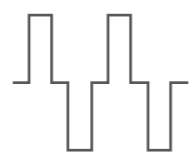

The Quasi sinus models create a modified AC wave. They are suitable for recharging most electric and electronic devices such as mobile phones, cameras, laptops, lighting (except neon)...

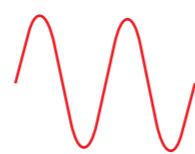

The Pure sinus models create a stable voltage of the same quality as the electrical grid. They can supply all devices even the most sensitive ones (neon, plasma screen, PC, microwave, etc.).

THE DC>DC RANGE



To supply your 12V electrical devices with your 24V battery. Ideal for lighting applications or for supplying 12V electrical devices.



High-end electronic and mechanical design

High conversion rate

Low self-consumption

Broad operating temperature range (-10°C to 45°C)

Protected against overloads, overconsumption, short circuits, reverse polarity, low battery

Inverters UNIPOWER

TRANSFORMS YOUR BATTERY INTO A POWER SUPPLY

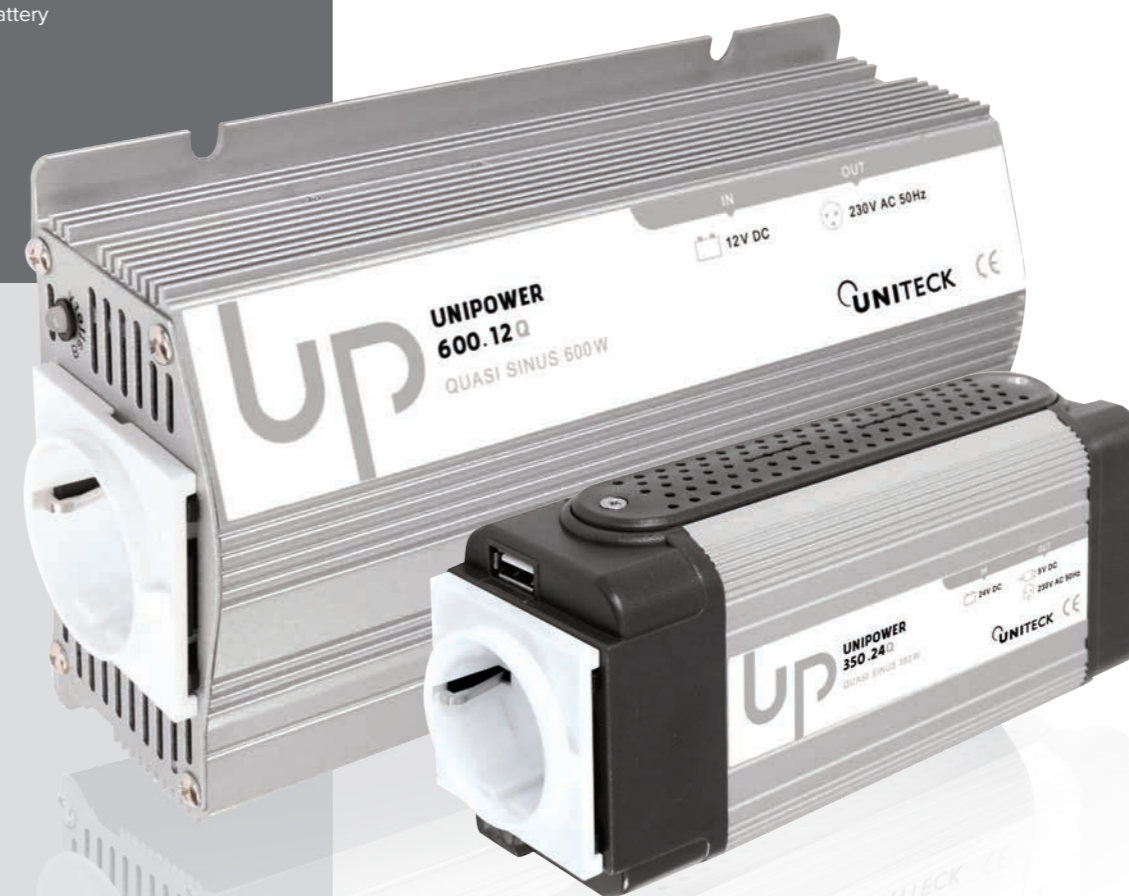

With an advanced electronic architecture coupled with robust mechanics (fans, connectors, wiring...), UNIPOWER has been developed for all uses, even the most intensive.

Their broad range of operating temperature (-10°C to 45°C) guarantees an optimum functioning in any situation (hold of a boat, under vehicle seats...).

Thanks to their high conversion rate and their low self-consumption, the UNIPOWER convert up to 20% more energy than a standard inverter.



Quality guaranteed by Uniteck

Made in Taiwan, packaged in France



Emission EMC : EN 55022 class B
Susceptibility EMC : EN 55024,
EN 61000-4-2, EN 61000-4-3, EN 61000-4-8
LVD : EN 60950-1

Inverters UNIPOWER 12 V > 230 V

QUASI SINUS



12 V > 230 V

PURE SINUS

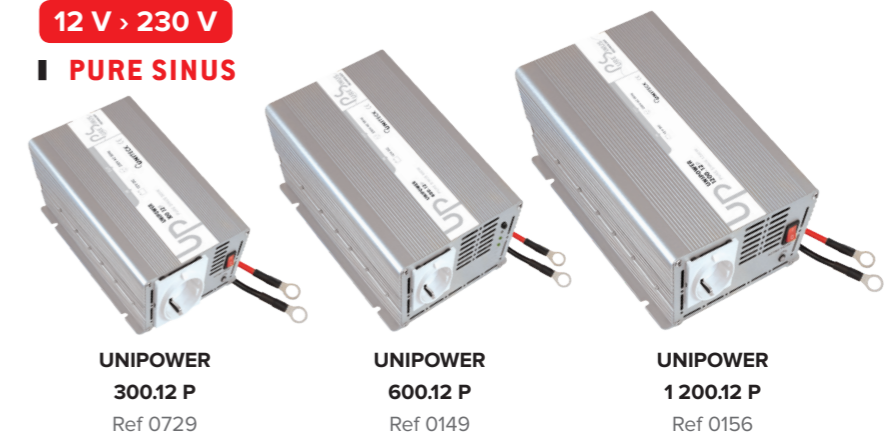

System	UNIPOWER 150.12 Q Ref 0101	UNIPOWER 350.12 Q Ref 0118	UNIPOWER 600.12 Q Ref 0125	UNIPOWER 1000.12 Q Ref 0132	UNIPOWER 2000.12 Q Ref 0613	UNIPOWER 300.12 P Ref 0729	UNIPOWER 600.12 P Ref 0149	UNIPOWER 1200.12 P Ref 0156
Conversion	12 VDC/230 VAC	12 VDC/230 VAC	12 VDC/230 VAC	12 VDC/230 VAC	12 VDC/230 VAC	12 VDC/230 VAC	12 VDC/230 VAC	12 VDC/230 VAC
Continuous/ peak power	150/300 W	350/700W	600/1 200W	1000/2 000W	2 000/4 000W	300/600W	600/1 200W	1200/2 400W
Technology	Quasi sinus	Quasi sinus	Quasi sinus	Quasi sinus	Quasi sinus	Pure sinus	Pure sinus	Pure sinus
self-consumption	0,2 A	0,25 A	0,5 A	0,6 A	0,4 A	0,3 A	0,9 A	1,1 A
max. efficiency	87%	87%	87%	87%	87%	90%	90%	90%
Remote display/ control	no	no	no	no	yes	no	no	no
Input	0,7 m	0,85 m	0,95 m	1 m	1 m	1 m	1 m	1 m
input voltage range	9,5 - 16 V	9,5 - 16 V	9,5 - 16 V	9,5 - 16 V	9,5 - 16 V	9,5 - 16 V	9,5 - 16 V	9,5 - 16 V
Surge protection	yes	yes	yes	yes	yes	yes	yes	yes
Low battery protection	yes	yes	yes	yes	yes	yes	yes	yes
Short circuit protection	yes	yes	yes	yes	yes	yes	yes	yes
Output								
Output voltage	230 V AC + USB 5V-1A DC	230 V AC + USB 5V-3A DC	230 V AC + USB 5V-3A DC	230 V AC	230 V AC	230 V AC	230 V AC	230 V AC
Frequency	50 Hz	50 Hz	50 Hz	50 Hz	50 Hz	50 Hz	50 Hz	50 Hz
Overconsumption protection	yes	yes	yes	yes	yes	yes	yes	yes
Polarity reversal protection	yes	yes	yes	yes	yes	yes	yes	yes
Mechanical characteristics								
International Protection rating	IP10	IP10	IP10	IP10	IP10	IP 10	IP 10	IP 10
Operating temperature	-15 > +45 °C	-15 > +45 °C	-15 > +45 °C	-15 > +45 °C	-15 > +45 °C	-15 > +45 °C	-15 > +45 °C	-15 > +45 °C
Humidity (without condensation)	90 % max.	90% max.	90% max.	90% max.	90% max.	90% max.	90% max.	90% max.
Storage temperature	-30° > 70°C	-30° > 70°C	-30° > 70°C	-30° > 70°C	-30° > 70°C	-30° > 70°C	-30° > 70°C	-30° > 70°C
Dimensions (mm)	155 × 85 × 55	180 × 85 × 55	220 × 123 × 65	195 × 179 × 82,5	425 × 179 × 82,5	260 × 129 × 82,5	195 × 179 × 82,5	435 × 179 × 82,5
Net weight without accessories	0,46 kg	0,56 kg	1,4 kg	2,4 kg	3,7 kg	2 kg	2,8 kg	4,4 kg
Net weight with accessories	0,49 kg	0,59 kg	1,8 kg	2,7 kg	4,3 kg	2,2 kg	3,0 kg	5 kg

200 W +
 40 W +
 100 W +
 90 W = 430 W

40 W +
 550 W +
 500 W = 1 090 W

QUASI SINUS

Start up coef.	1x	1x	1x	1x	1x	1x	3x	1x	1x	1x	1,5x	2x	3x	1x	1x/2
Continuous power	5 W	20 W		50 W	100 W	200 W				600 W				1000 W	1300 W

PURE SINUS

	5x/10	20 W	1,5x	5x/10	1x	1,5x
	50 W	100 W	200 W	500 W		

- UNIPOWER 150.12 Q
- UNIPOWER 350.12 Q
- UNIPOWER 600.12 Q
- UNIPOWER 1000.12 Q
- UNIPOWER 2000.12 Q
- UNIPOWER 300.12 P
- UNIPOWER 600.12 P
- UNIPOWER 1200.12 P

- UNIPOWER 300.12 P
- UNIPOWER 600.12 P
- UNIPOWER 1200.12 P

N.B.: Powers and start-up ratios are given on an indicative basis. For more information, refer to the values indicated on the identification plate or in the user manual of the device that needs to be supplied.

Inverters UNIPOWER 24 V > 230 V

QUASI SINUS

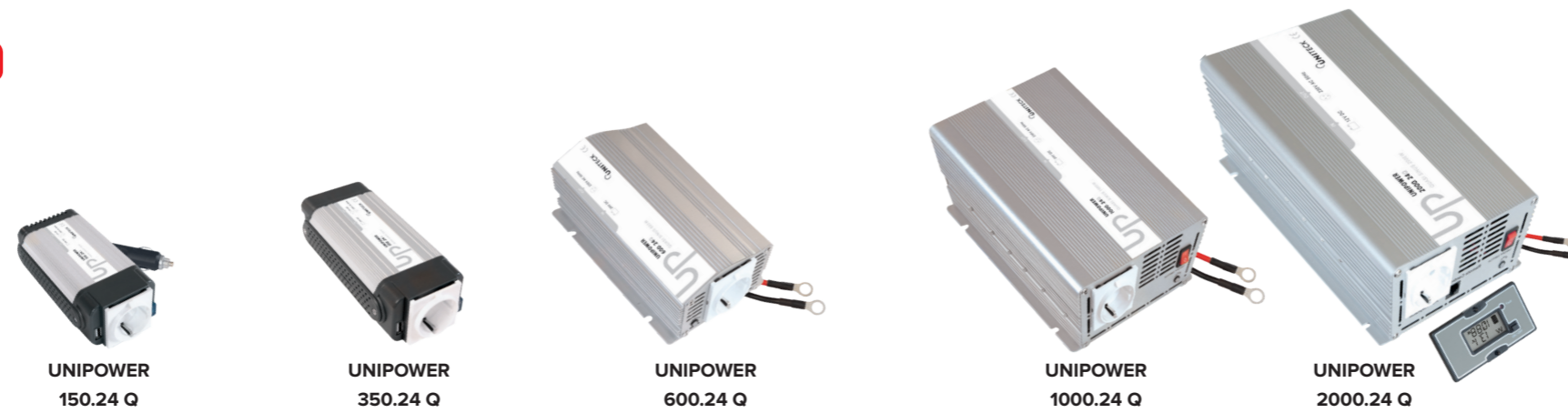

UNIPOWER
150.24 Q

UNIPOWER
350.24 Q

UNIPOWER
600.24 Q

UNIPOWER
1000.24 Q

UNIPOWER
2000.24 Q

UNIPOWER
200.12 DC

Ref 1030

Ref 1047

Ref 0736

Ref 0743

Ref 0750

Ref 0651

System

Conversion	24 VDC/230 VAC	24 VDC/230 VAC	24 VDC/230 VAC	24 VDC/230 VAC	24 VDC/230 VAC	24 V DC/12 V DC
Continuous/ peak power	150/300 W	350/700W	600/1 200W	1000/2 000W	2 000/4 000W	200/300W
Technology	Quasi sinus	Quasi sinus	Quasi sinus	Quasi sinus	Quasi sinus	Inverter
Self-consumption	0,1 A	0,2 A	0,3 A	0,3 A	0,2 A	0,3 A
Max. efficiency	87%	87%	87%	87%	87%	87%
Remote display/ control	no	no	no	no	yes	no

Input

	0,7 m	0,85 m	0,95 m	1 m	1 m	in
Input voltage range	20 - 32 V	20 - 32 V	20 - 32 V	20 - 32 V	20 - 32 V	18 - 30 V DC
Surge protection	yes	yes	yes	yes	yes	yes
Low battery protection	yes	yes	yes	yes	yes	yes
Short circuit protection	yes	yes	yes	yes	yes	yes

Output

						out
Output voltage	230 V AC+USB 5V-1A DC	230 V AC+USB 5V-3A DC	230 V AC+USB 5V-3A DC	230 V AC	230 V AC	12-13 V DC
Frequency	50 Hz	50 Hz	50 Hz	50 Hz	50 Hz	-
Overconsumption protection	yes	yes	yes	yes	yes	yes
Polarity reversal protection	yes	yes	yes	yes	yes	yes

Mechanical characteristics

International Protection rating	IP10	IP10	IP10	IP10	IP10	IP 10
Operating temperature	-15 > 45°C	-15 > 45 °C	-15 > 45°C	-15 > 45°C	-15 > 45°C	-15 > 45°C
Humidity (without condensation)	90% max.	90 % max.	90% max.	90% max.	90% max.	90% max.
Storage temperature	-30 > 70°C	-30 > 70 °C	-30 > 70°C	-30 > 70°C	-30 > 70°C	-30 > 70 °C
Dimensions	155 × 85 × 55 mm	180 × 85 × 55 mm	220 × 123 × 65 mm	195 × 179 × 82,5 mm	425 × 179 × 82,5 mm	178 × 89 × 50 mm
Net weight without accessories	0,46 kg	0,56 kg	1,4 kg	2,4 kg	3,7 kg	0,6 kg
Net weight with accessories	0,49 kg	0,59 kg	1,8 kg	2,7 kg	4,3 kg	0,6 kg

200 W + 40 W + 100 W + 90 W = 430 W

40 W + 550 W + 500 W = 1090 W

Start up coef.	1x	1x	1x	1x	1x	1x	1x	3x	1x	1x	1x	1,5x	2x	3x	1x	1x/2
Continuous power	5 W	20 W			50 W	100 W	200 W		600 W						1000 W	1300 W

24 V > 230 V

- UNIPOWER 150.24 Q
- UNIPOWER 350.24 Q
- UNIPOWER 600.24 Q
- UNIPOWER 1000.24 Q
- UNIPOWER 2000.24 Q

24 V > 12 V DC

- UNIPOWER 200.12 DC

N.B.: Powers and start-up ratios are given on an indicative basis. For more information, refer to the values indicated on the identification plate or in the user manual of the device that needs to be supplied.



LIGHT, MOBILE AND POWERFUL

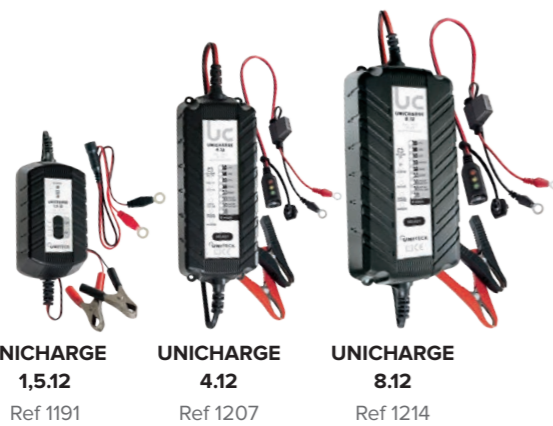

System

	UNICHARGE 1.5.12 Ref 1191	UNICHARGE 4.12 Ref 1207	UNICHARGE 8.12 Ref 1214
AC input voltage	230 V AC ±10% 50Hz	230 V AC ±10% 50Hz	230 V AC ±10% 50Hz
DC output voltage	6 V-12 V	6 V-12 V	12 V
Maximum power	28 W	75 W	150 W
Charging technology	automatic, multi-stage	automatic, multi-stage	automatic, multi-stage

Battery

	UNICHARGE 1.5.12	UNICHARGE 4.12	UNICHARGE 8.12
Battery types	lead-acid liquid, AGM, gel	lead-acid liquid, AGM, gel	lead-acid liquid, AGM, gel
Accepted battery voltage	6 V-12 V	6 V-12 V	12 V
Battery capacity	8-40 Ah	2-120 Ah	10-250 Ah

Charge

	UNICHARGE 1.5.12	UNICHARGE 4.12	UNICHARGE 8.12
Charging intensity	1,5 A	1/4 A	2/8 A
Charging stages	4	8	9
Minimum battery voltage	3,5 V	0V (manual) 5 V (automatic)	0V (manual) 5 V (automatic)

Connections

	UNICHARGE 1.5.12	UNICHARGE 4.12	UNICHARGE 8.12
Clamps	yes	yes	yes
Eyelets	yes	yes, with Charge control	yes, with Charge control

Mechanical characteristics

	UNICHARGE 1.5.12	UNICHARGE 4.12	UNICHARGE 8.12
Protection rating	IP65	IP65	IP65
Operating temperature	-10° > +50°C	-10° > +50°C	-10° > +50°C
Storage temperature	-20° > +70°C	-20° > +70°C	-20° > +70°C
Dimensions in mm (wxhxd)	109x47x85	176,6x72,4x48,9	202,6x92,5x59,1
Weight	250 g	530 g	740 g



Standard eyelet connection

(for Unicharge 1.5.12 only - included with charger)
Ref 0583



Eyelet connection with Charge control technology

(for Unicharge 4.12/8.12 only -included with charger)
Ref 0590

PROLONGED BATTERY LIFESPAN

- 1 Test**
Analysis of the battery's condition.
- 2 Repair sulfated battery***
Recovery of sulfated batteries (extended deep discharge).
- 3 Repair low battery***
Recovery of deeply discharged batteries.
- 4 Boost charge**
Fast charge at maximum power.
- 5 Equalisation**
Equalisation of the charge at 100% on all battery elements.
- 6 Recondition**
Mixing of the battery in order to avoid all stratification phenomenon.
- 7 Charge Diagnostic**
Verification of the battery's ability to hold the charge.
- 8 100%**
Keeping the battery's charge at 100% (floating).
- 9 Life+/Storage**
Compensation of the natural selfdischarge of the battery, with pulse charge for more battery lifespan.

*UNICHARGE 4.12 and 8.12 only
**UNICHARGE 8.12 only

Quality guaranteed by Uniteck
Made in P.R.C., packaged in France

EN 60335-1, EN 60335-2-29 & EN 55014-1 / EN 55014-2, EN 61000-3-2 - EN61000-3-3 - EN 62233

Battery chargers UNICHARGE

REPAIRS, RECHARGES AND PRESERVES YOUR BATTERIES

With a last generation multi-stage charging algorithm, UNICHARGE perfectly recharges all the way to 100% and without supervision all lead-acid batteries : liquid electrolyte, flooded and AGM (maintenance-free).

Designed and developed for all uses, UNICHARGE is the ideal charger to recharge solar batteries, vehicles batteries (car, motorcycle, scooter, snow scooter, tractor, agricultural machines), boat batteries, alarm batteries, fence batteries...

UNICHARGE 4.12 and 8.12 are much more than simple standard chargers, they :

- repair and recharge deeply discharged batteries (>0V),
- repair batteries which could have started a stratification process,
- preserve batteries from all stratification phenomenon (recondition mode, 8.12 model),
- avoid self-discharge of the batteries during long winters or storage periods while improving their lifespan.

UNICHARGE is fitted as standard with a clamp connection kit, but also with an eyelet connection kit, ideal for regular charges or for hard to access batteries. Moreover, the 4.12 and 8.12 models dispose of charge control technology on their eyelet connection, which allows to visually and simply check the level of charge of your battery.

	UNICHARGE		
	1.5.12	4.12	8.12
150-200 Ah	80-107 h	30-40 h	15-20 h
60-150 Ah	32-80 h	12-30 h	8-15 h
80-150 Ah	43-80 h	16-30 h	8-15 h
45-120 Ah	24-64 h	9-24 h	4.5-12 h
10-30 Ah	5-16 h	2-6 h	1-3 h
10-30 Ah	5-16 h	2-6 h	1-3 h
5-20 Ah	3-11 h	1-4 h	0.5-2 h

Indicative duration for a 80% charge

x-x h recommended
x-x h adapted but the charge may be longer or too fast compared to a recommended charger

+ UNITECK

Tests, charges at 100%, avoids sulphation and stratification, maintains the charge and improves the battery's lifespan.

automatically memorizes and restarts with the last mode in use in case of power failure

Polarity reversals, short circuits, thermal, sparks protection

Protected against dust and water projections (IP65)

Controlled by a microprocessor





UNIMOS 80.24/2 Ref 1399
 UNIMOS 120.24/2 Ref 1511
 UNIMOS 160.24/3 Ref 1405
 UNIMOS 200.24/3 Ref 1412

System

Technology	MOS	MOS	MOS	MOS
Operating voltage	12/24 V	12/24 V	12/24 V	12/24 V
max. intensity	80 A	120 A	160 A	200 A

Battery

Accepted battery voltage	12/24 V	12/24 V	12/24 V	12/24 V
number of outputs	2	2	3	3

Charge

max. current	80 A	120 A	160 A	200 A
voltage drop at end of charging cycle	10 A 20 A 50 A	0 V 0,01 V 0,05 V	0 V 0,01 V 0,05 V	0 V 0,01 V 0,05 V

Alternator

with excitation current (IG terminal)	yes	yes	yes	yes
without excitation current	yes	yes	yes	yes
max. current	80 A	120 A	160 A	200 A

Mechanical characteristics

Operating temperature	-20°+60°C	-20°+60°C	-20°+60°C	-20°+60°C
Storage temperature	-30°+80°C	-30°+80°C	-30°+80°C	-30°+80°C
Dimensions in mm (wxhxd)	110x70x35	110x70x35	145x85x35	145x85x35
Weight	125 g	135 g	300 g	300 g



CENTRALISED CHARGING MANAGEMENT

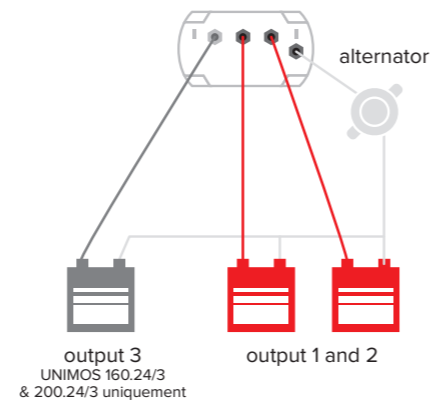

OPTIMISED RESTITUTION

Load distributor		
with a diode	with a standard MOS system	UNIMOS
compactness		
--	+	+++
restituted charging power		
- loss 3 > 6%	+ loss 0,5 > 4%	+++ loss 0,01 > 0,5%
restituted charging voltage		
- loss 0,7 V	+ loss 0,1 > 0,2 V	+++ loss 0,01 V

PERFECT CHARGE

UNIMOS Guarantees a 100% charge of your battery

Load distributor		
with a diode	with a standard MOS system	UNIMOS
alternator charging power		
14,2 V	14,2 V	14,2 V
voltage drop due to cable (2%)		
-0,3 V	-0,3 V	-0,3 V
voltage drop due to distributor		
-0,7 V	-0,2 V	-0,01 V
output voltage from distributor		
13,2 V	13,7 V	13,9 V
Battery's charging level (end of charge 13,9V floating)		
80% -0,7 V	90% -0,2 V	100% 0 V

Battery isolators UNIMOS

COMPACTNESS AND PERFORMANCE



Designed, made in France

MOS LOW VOLTAGE DROP TECHNOLOGY

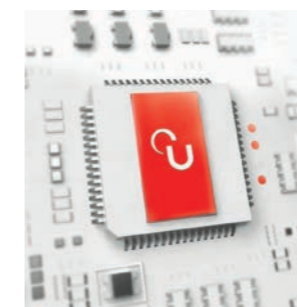

The UNIMOS range is revolutionizing the market of battery isolators. UNIMOS distributes the charge of your alternator on each of your batteries without loss of power while isolating each battery to prevent them from unloading each other.

Thanks to its latest generation electronics (Low Voltage Drop MOSFET) combined with its power connectors directly soldered on the electronic board, UNIMOS offers:

- exceptional compactness (up to x5 smaller),
- Up to x10 less power loss compared to other MOSFET battery Isolators on the market,
- a faster charge,
- a gain in energy and / or fuel.

+ UNITECK

- Exceptional efficiency
- Direct to PCB power connector for faster energy transfer without loss of power
- Low voltage drop MOS technology for communication without voltage drop
- Exceptional compactness
- 100% made in France (design, build, electronic card, mechanics...)

12V accessories



UNIDETECT 5.12
5 A-12 V
Ref 1719
UNIDETECT 10.12
10 A-12 V
Ref 0668

UNIDETECT, the twilight motion sensor

Ideal for use in combination with lights, alarms or video surveillance. The Passive infrared (PIR) technology automatically switches your 12V electrical device (eg alarm, spot ...) on, day and night, as soon as it detects a moving heat source within its range. Protected against rain (IP44), UNIDETECT is suitable for indoor and outdoor use. It can be wall mounted or ceiling mounted. Its high-end sensor guarantees a wide area and detection range (120° / up to 10 meters).
Adjustable for more precision:

- it operates either 24H / 24 or according to a predetermined brightness level,
- the switching on time is also adjustable.



UNITIMER 16.12
16 A-12 V
Ref 1221
UNITIMER 16.24
16 A-24 V
Ref 1382

UNITIMER to switch your 12 or 24V devices on and off automatically and with precision

UNITIMER is the ideal electronic programmer for your network, or photovoltaic installations or 12 or 24 V network. UNITIMER turns your 12V electrical devices automatically and accurately on and off. Its applications are many: lighting, watering, fountains, preheating, light display, alarm, video surveillance... This way UNITIMER saves your energy for more amplitude of operation. UNITIMER has many advantages:

- more than 17 different ignition and extinction programs available (weekend, everyday choice, multi-day ...),
- LCD display with transparent protective cover,
- NO or NC connection (NO = normally opened, NF = normally closed) for more security depending on your uses,
- Built-in lithium battery to preserve your programs in case of power failure.



UNISPLIT 160.12
160 A-12 V
Ref 0927

UNISPLIT, to couple and recharge your batteries in complete safety

UNISPLIT is the ideal isolator/ combiner for a variety of uses in vehicles, boats or isolated sites. Equipped with a high power monoblock relay (160A), UNISPLIT 160.12 has been developed to ensure optimum operation on most alternators, even those of the latest generation vehicles with a charging current greater than 120A.

UNISPLIT can:

- Charge a whole fleet of batteries as soon as a charge (alternator, charger ...) is detected on the main battery by coupling the batteries together,
- Prevent them from self-unloading, disconnecting when the load stops.

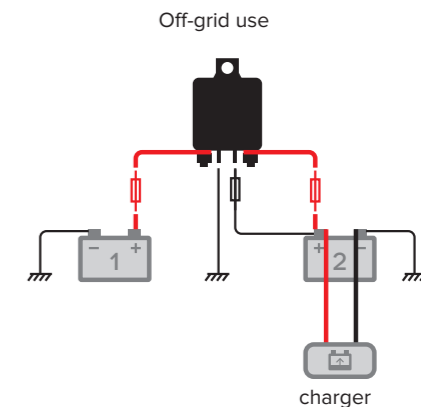

Use with vehicle with alternator

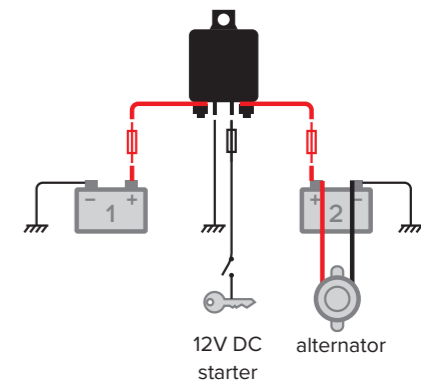

- wide detection angle (120°)
- high detection range (10m)
- Adjustable detection period (day and/or night)
- Adjustable switching on time
- Protected against rain
- broad range of operating temperature (-20/+45°C)

System
Input/output voltage : 12-30 V DC
Max. intensity : 10A
Self-consumption : 2 mA
Protection rating : IP44
Operating temperature : -20°C to +45°C

Sensor
Detection zone : 120°
Detection range : about 1 to 10 m
Adjusting switching on time: 5 s to 15 min (continuous)
Adjusting the brightness sensitivity: 5 to 1000 Lux (continuous)

Mechanical characteristics
Dimensions (w x h x d) : 100 x 80 x 17 mm
Weight : 150 g



Quality guaranteed by Uniteck
Made in Taiwan,
packaged in France

- up to 17 programs
- low self-consumption
- Back up on Lithium battery
- Protected against rain
- broad range of operating temperature (-10/+40°C)

System
Input current: 12 or 24V (depending on model)
Max. DC current : 16 A
Self-consumption : 0,35A max.
Protection rating : IP44
Operating temperature : -10°C to +40°C
Max. cable section : 6 mm²

Timer
Number of programs : 17 ON/OFFs
Interval between 2 programs : 1 min
Program backup : lithium battery (3 years)

Mechanical characteristics
Dimensions (w x h x d) : 86,5 x 36 x 65 mm
Weight : 110 g



Quality guaranteed by Uniteck
Made in P.R.C.,
packaged in France

- Controlled by microprocessor
- High power monoblock relay
Resin electronic board
- Broad range of operating temperature (-40/+85°C)

System
Battery voltage : 12 V DC
Operating voltage : 9-15 V DC
Technology: single high power relay, microprocessor controlled International
Protection rating : IP53
Operating temperature : -40°C to +85°C

Isolator/combiner
Disconnection voltage : 12,8 V
Re-connection voltage : 13,4 V
Connection delay : 10s +/- 5%
Nominal current : 160 A
Peak current : 500 A during 1s at 23°C

Mechanical characteristics
Dimension (w x h x d) : 77 x 46 x 166 mm
Weight : 300 g



Quality guaranteed by Uniteck,
Made in Germany,
packaged in France



Isolator/ combiner fuse protection kit
Protects your installation and your battery against malfunctions (short circuit, battery fault, overcurrent ...).
Included: fuse and fuse holder (150A x2 + 5A x1)
Ref 1313

UNITECK SIMPLIFIES YOUR CHOICE



ROAD SIGNS GUIDE



BOATING GUIDE



CAMPERVAN GUIDE



LEISURE GUIDE

i Battery connection

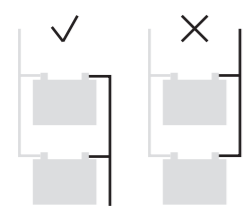

Prefer a diagonal wiring for a uniform charge and discharge.

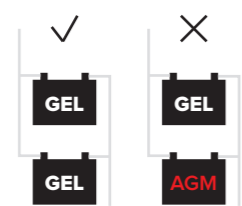

Do not pair batteries with different capacities, different ages or different technologies.

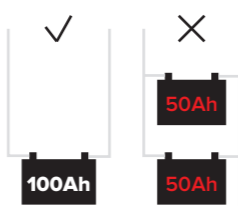

At equal capacity, prefer a big battery instead of two small ones connected in parallel.

i Panel orientation and inclination

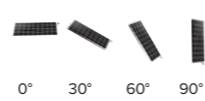

	0°	30°	60°	90°
E	93 %	90 %	78 %	55 %
SE	93 %	96 %	88 %	66 %
S	93 %	100 %	91 %	68 %
SW	93 %	96 %	88 %	66 %
W	93 %	90 %	78 %	55 %

Guide

ROAD SIGNS

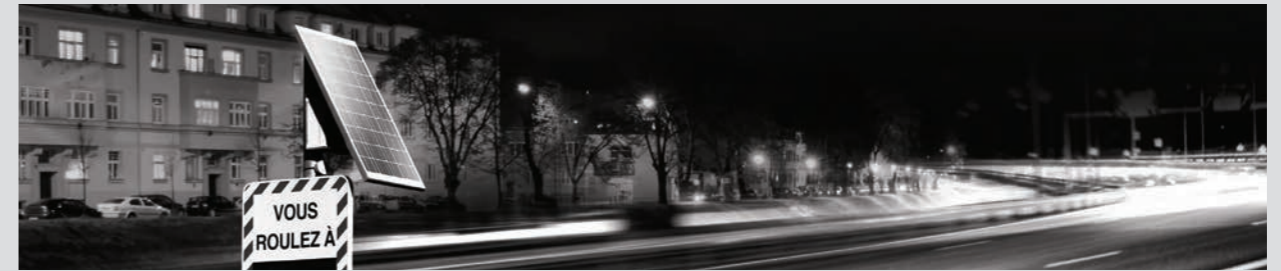

SET UP YOUR SOLAR KIT

		Fixed 20 W	Adjustable 20 W	Fixed 50 W	Adjustable 50 W	Fixed 80 W	Adjustable 80 W	Fixed 100 W	Adjustable 100 W	Adjustable 150 W	
Solar panel											
	UNISUN 20.12M ref. 0071	x1	x1								
	UNISUN 50.12M ref. 0088			x1	x1						
				or	or						
	UNISUN 55.12BC ref. 1238			x1	x1						
	UNISUN 80.12M ref. 0095					x1	x1				
	UNISUN 100.12M ref. 0446							x1	x1		
								or	or		
	UNISUN 110.12BC ref. 1245							x1	x1		
	UNISUN 150.12M ref. 0453									x1	
	Mounting bracket										
	UNIFIX 20SF ref. 1139	x1									
	UNIFIX 20S ref. 0286		x1								
	UNIFIX 50S ref. 0293				x1						
	UNIFIX 100SF ref. 1146			x1		x1		x1			
	UNIFIX 100S ref. 0323						x1		x1		
	UNIFIX 150S ref. 0866									x1	
Wiring											
	UNICONNECT ref. 0811	x1	x1	x1	x1	x1	x1	x1	x1	x1	
	Road signs										
Charge controller											
	UNISOLAR 10.24 ref. 0002	x1	x1	x1	x1	x1	x1	x1	x1	x1	
	Produced power Wh/d (north-south of France)										
	January/February	15-25	15-25	40-60	40-60	65-95	65-95	80-120	80-120	120-180	
	March/October	60-80	60-80	150-200	150-200	180-320	180-320	300-400	300-400	450-600	
July/August	100-140	100-140	230-350	230-350	400-560	400-560	500-700	500-700	750-1050		

GUIDE

CAMPERVAN



ENSURE YOUR ELECTRICAL AUTONOMY

The Uniteck Camping-Car kits guarantee the best electrical autonomy on the market while preserving the lifespan of your battery.

The latest-generation MPPT controllers, manufactured in France, test your battery, recharge it to 100%, desulfate it, delaminate it, maintain its charge and improve its service life.

The optimized MPPT program, coupled with the fastest micro-processor on the market, checks in real time (every 100 ms), the maximum power point of the panel. This guarantees up to 40% more energy in the winter and 15% more energy in the summer compared to a PWM controller, even in changing weather conditions.

Thanks to its Back Contact technology, the UNITECK BC solar panels have the best performance on the market. Equipped with 6mm² cables with quick solar connectors fitted as standard, Uniteck kits are easily upgradable for more power.

Your electrical devices	Voltage (V)	Average current (A)	Efficiency	Power (Watt)	Time of use (h/day)	Consumption/d (Wh/day)	Battery capacity (Ah/day)
Lighting							
Square	12	1	1	12	3	35	6
Bunk	12	1	1	12	3	35	6
Bathroom	12	1	1	12	1	12	2
Kitchen	12	1	1	12	1	12	2
Chart table	12	1	1	12	2	25	4
Comfort							
Fan	12	5	1	60	1	60	10
Air conditioning	230	3	0,8	830	3	2500	417
Water pump (WC/freshwater)	12	6	1	70	0,25	20	3
Kettle	230	6,5	0,8	1900	0,1	190	30
Hairdryer	230	2,8	0,8	800	0,1	80	13
Refrigerator (40W/60W with gas-electric timer)	12	3,4	1	40	8	320	55
Electronics							
LCD Tv (55cm)/turned on	12	2,5	1	30	6	180	30
LCD Tv (55cm)/ on standby	12	1	1	12	18	215	36
Mobile phone	230	0,1	0,8	30	1	30	5
Radio/CD player	12	1	1	12	3	35	6
Microcomputer turned on	230	0,3	0,8	90	3	270	45
Microcomputer on standby	230	0,02	0,8	5	21	105	17

Calculation explanation $(V) \times (A) \div (Efficiency) = (W) \times (h/d) = (Wh/d) \div 12 V \div 50\% = (Ah)$

*Recommended self-discharge battery ratio

i Cost of an electrical connection in a resting area or camping plot : 4€/day, or 120€ for 30 days per year.

SET UP YOUR SOLAR KIT

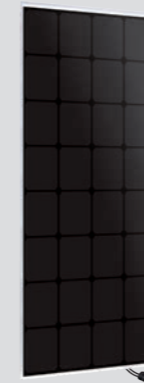

100 W 150 W 200 W 300 W

Solar panel

UNISUN 80.12M	ref. 0095				
UNISUN 100.12M	ref. 0446	x1		x2	
		or		or	
UNISUN 110.12BC	ref. 1245	x1		x2	
UNISUN 150.12M	ref. 0453		x1		x2
				or	
UNISUN 150.12BC	ref. 1528				x2

Mounting bracket

UNIFIX 1.C	ref. 0255	x1	x1	x2	x2
------------	-----------	----	----	----	----

Wiring

UNICABLE 651 BR	ref. 1023	x1	x1	x1	x1
Parallel connectors kit	ref. 0231			x1	x1
Waterproof Roof-pass	ref. 0248	x1	x1	x1	x1

Charge controller

UNIMPPT 30/10.12S	ref. 0989	x1	x1		
UNIMPPT 60/20.24S	ref. 1726			x1	x1

Produced power Wh/d (north-south of France)

January/February	80-120	120-180	160-240	240-360
March/October	300-400	450-600	600-800	900-1200
July/August	500-700	750-1050	1000-1400	1500-2100

Injected capacity Ah/d (north-south of France)

January/February	6-10	10-15	13-20	20-30
March/October	25-33	38-50	50-65	76-100
July/August	40-58	62-87	80-155	124-174

LEISURE



ENSURE YOUR AUTONOMY FOR LEISURE

The Uniteck Leisure Kits guarantee the best electrical autonomy on the market while preserving the lifespan of your battery.

The latest-generation MPPT controllers, manufactured in France, test your battery, recharge it 100%, desulfate it, delaminate it, maintain its charge and improve its service life. The optimized MPPT program coupled with the fastest microprocessor on the market checks in real time (every 100 ms), the maximum power point of the panel. This way it guarantees up to 40% more energy in the winter and 15% more energy in the summer compared to a PWM controller, even in changing weather conditions.

The UNITECK solar panels guarantee exceptional efficiency, even in very low sun or extreme heat. Equipped with 6mm² cables with quick solar connectors fitted as standard, Uniteck kits are easily upgradable for more power.

The mounting brackets with a multi-position tilt system optimize the electrical performance of your installation.

Your electrical devices

	Voltage (V)	Average current (A)	Efficiency	Power (Watt)	Time of use (h/day)	Daily consumption (Wh/day)	Battery capacity (Ah/day)
Lighting	Led (6W)	230	0,02	6	4	25	4
	lamp post with energy saving bulb (25W)	230	0,1	30	4	120	19
	Incandescent lamp (70W)	230	0,3	85	4	340	58
	Halogen lamp (300W)	230	1,3	375	4	1500	249
Comfort	Refrigerator (100 l - 120 kW/year)	230	0,05	14	24	335	55
	Fan	230	70	40	4	160	27
Electronics	Mobile phone	230	0,1	30	1	30	5
	Camera	230	0,1	30	1	30	5
	Radio/CD player	12	1	12	4	48	8
	Microcomputer on standby	230	0,02	5	23	115	20
	Active microcomputer	230	0,3	90	1	90	15
	Lcd TV (55cm) turned on	230	0,2	45	2	90	15
Lcd TV (55 cm) on standby 1A	230	0,003	1	1	22	4	
handiwork	Hedge trimmer	230	2,1	600	1	600	100
	Drilling machine	230	2,1	600	1	600	100

Calculation explanation $V \times A \div (\%) = (W) \times (h/d) = (Wh/d) \div 12 V \div 50\% = (Ah)$

*Recommended self-discharge battery ratio

i Cost of a traditional electrical connection (ex. : garden shed located at 30m of the house) : circuit breaker 40€, cable 2,5€/m or 75€ total length, trench 15€/m or 450€ total length. Total : 565€

CONFIGURE YOUR SOLAR KIT

	20 W	50 W	100 W	150 W	200 W	300 W	450 W	600 W
Solar panel								
UNISUN 20.12M ref. 0071	x1							
UNISUN 50.12M ref. 0088		x1						
		or						
UNISUN 55.12BC ref. 1238		x1						
UNISUN 100.12M ref. 0446			x1		x2			
		or			or			
UNISUN 110.12BC ref. 1245			x1		x2			
UNISUN 150.12M ref. 0453				x1		x2	x3	
UNISUN 200.24M ref. 1337								x3
Mounting bracket								
UNIFIX 20 ref. 0262	x1							
UNIFIX 50 ref. 0279		x1						
UNIFIX 100 ref. 0316			x1					
		or						
UNIFIX 100B ref. 0644			x1		x2			
UNIFIX 150B ref. 0545				x1		x2	x3	
		or			or			
UNIFIX 200 ref. 0361				x1	x1	or		
UNIFIX 300 ref. 0378						x1		x3
Wiring								
UNICONNECT 1.6 ref. 0200	x1	x1	x1	x1	x1	x1	x1	x1
Connectors kit	2 panels ref. 0231					x1	x1	
	3 panels ref. 0163						x1	x1
Charge controller								
UNIMPPT 30/10.12S ref. 0989	x1	x1	x1	x1				
UNIMPPT 60/20.24 ref. 1726					x1	x1		
UNIMPPT 60/40.12S ref. 1467							x1	
UNIMPPT 100/60.24S ref. 1474								x1
Produced power Wh/d (north-south of France)								
January/February	15-25	40-60	80-120	120-180	160-240	240-360	360-540	480-720
March/October	60-80	150-200	300-400	450-600	600-800	900-1200	1350-1800	1800-2400
July/August	100-150	230-350	500-700	750-1050	1000-1400	1500-2100	2250-3150	3000-4200
Injected capacity Ah/d (north-south of France)								
January/February	1-2	3-5	6-10	10-15	13-20	20-30	30-45	40-60
March/October	5-7	12-17	25-33	38-50	50-65	76-100	112-150	150-200
July/August	8-12	20-29	40-58	62-87	80-155	124-174	187-262	250-350
Recommended battery Ah								
min	20	60	80	150	170	190	220	300
max	50	90	120	200	300	350	500	700



French manufacturer
of off-grid small power
solar equipment

Uniteck Sarl
8 avenue de Rome
Immeuble Le Cassis
34350 Vendres

Tel. : +33(0)4.99.41.06.88
Fax : +33(0)4.88.04.72.20
E-mail : contact@uniteck.fr

Siren : 789 348 711
Siret : 789 348 711 00019
RCS Béziers
APE : 2790Z
Intra-community VAT : FR 83 789 348 711
Capital 100 000 €

www.uniteck.fr

