



875-0387-0

**Vector V123_V133
GNSS Compass**

User Guide
Revision: A3
August 31, 2022

Table of Contents

Device Compliance, License and Patents.....	4
Terms and Definitions	6
Chapter 1: Introduction.....	8
Overview	8
Product Overview.....	9
Key Features.....	13
What’s Included in Your Kit	14
Using PocketMax4 to Communicate with the V123_V133	16
Firmware Upgrades	20
Chapter 2: Installing the V123_V133.....	25
Overview	25
Mounting the V123_V133	26
Ports	43
Selecting Baud Rates and Message Types	45
Connecting the V123_V133 to External Devices	46
Chapter 3: Understanding the V123_V133	49
Overview	49
Differential Operation	50
SBAS Tracking.....	50
GNSS Overview.....	51
Atlas L-band.....	52
Supplemental Sensors	53
Time Constants.....	56
Chapter 4: Operating the V123_V133	58
Overview	58
Powering the V123_V133.....	59
Beacon Operation	60
Alarm Functionality	61

Appendix A: Troubleshooting.....	62
Overview	62
Troubleshooting	63
Appendix B: Technical Specifications	67
Technical Specifications	67
V123_V133 Technical Specifications	68
Appendix C: Commands and Messages.....	71
Overview	71
Commands	72
Binary Messages.....	74
NMEA Messages.....	76
Index	93
End User License Agreement.....	94
Warranty Notice.....	98

Device Compliance, License and Patents

Device Compliance

This device complies with part 15 of the FCC Rules. Operation is subject to the following two conditions:

1. This device may not cause harmful interference, and
2. this device must accept any interference received, including interference that may cause undesired operation.

This product complies with the essential requirements and other relevant provisions of Directive 2014/53/EU. The declaration of conformity may be consulted at [HTTPS://HEMISPHEREGNSS.COM/ABOUT-US/QUALITY-COMMITMENT](https://hemispheregnss.com/about-us/quality-commitment).

Copyright Notice

Copyright Hemisphere GNSS, Inc. (2018). All rights reserved.

No part of this manual may be reproduced, transmitted, transcribed, stored in a retrieval system or translated into any language or computer language, in any form or by any means, electronic, mechanical, magnetic, optical, chemical, manual or otherwise, without the prior written permission of Hemisphere GNSS.

Trademarks

Hemisphere GNSS®, the Hemisphere GNSS logo, TRACER™, Crescent®, Eclipse™, e-Dif®, L-Dif™, PocketMax4™, S320™, SBX-4™, Vector™, XF1™, and XF2™ are proprietary trademarks of Hemisphere GNSS, Inc. Other trademarks are the properties of their respective owners.

Patents

Hemisphere GNSS products may be covered by one or more of the following patents:

Patents			
6111549	6876920	7400956	8000381
6397147	7142956	7429952	8018376
6469663	7162348	7437230	8085196
6501346	7277792	7460942	8102325
6539303	7292185	7689354	8138970
6549091	7292186	7808428	8140223
6711501	7373231	7835832	8174437
6744404	7388539	7885745	8184050
6865465	7400294	7948769	8190337
8214111	8217833	8265826	8271194
8307535	8311696	8334804	RE41358

Australia Patents	
2002244539	2002325645
2004320401	

Continued on next page

Device Compliance, License and Patents, Continued

Notice to Customers Contact your local dealer for technical assistance. To find the authorized dealer near you:

Hemisphere GNSS, Inc
8515 East Anderson Drive
Scottsdale, AZ 85255 USA
Phone: (480) 348-6380
Fax: (480) 270-5070
PRECISION@HGSS.COM
WWW.HGSS.COM

Technical Support If you need to contact Hemisphere GNSS Technical Support:

Hemisphere GNSS, Inc.
8515 East Anderson Drive
Scottsdale, AZ 85255 USA
Phone: (480) 348-6380
Fax: (480) 270-5070
SUPPORT.HGSS.COM

Documentation Feedback Hemisphere GNSS is committed to the quality and continuous improvement of our products and services. We urge you to provide Hemisphere GNSS with any feedback regarding this guide by opening a support case at the following website: SUPPORT.HGSS.COM

Terms and Definitions

Introduction

The following table lists the terms and definitions used in this document.

V123_V133 terms & definitions

Term	Definition
Activation	Activation refers to a feature added through a one-time purchase.
Atlas	Atlas is a subscription-based service provided by Hemisphere that enables the V123_V133 to achieve sub-meter accuracy without a base station or datalink.
Beacon	Refers to a base station that transmits a DGPS signal over a radio frequency between 283.5 and 325.0 kHz.
Base Station	The Base Station is a receiver placed over a familiar point, provides real-time observations, and sends those observations to nearby RTK rovers via UHF radio or the internet.
BeiDou	BeiDou is a Chinese satellite-based navigation system.
DGPS/DGNSS	Differential GPS/GNSS refers to a receiver using Differential Corrections.
Differential Corrections	A method of improving precision of a GNSS rover. Two GNSS receivers placed in a nearby area will have similar error. A base station is placed over a known point.
Elevation Mask	Elevation Mask is the minimum angle between a satellite and the horizon for the receiver to use that satellite in the solution.

Continued on next page

Terms and Definitions, Continued

V123_V133
terms &
definitions,
continued

Term	Definition
Firmware	Firmware is the software loaded into the receiver that controls the functionality of the receiver and runs the GNSS engine.
GALILEO	Galileo is a global navigation satellite system implemented by the European Union and European Space Agency.
GLONASS	Global Orbiting Navigation Satellite System (GLONASS) is a Global Navigation Satellite System deployed and maintained by Russia.
Heading	The vector created from the primary to secondary antenna. It points to the direction that the receiver is facing
Vector Receiver	A Hemisphere GNSS receiver capable of providing heading

Chapter 1: Introduction

Overview

Introduction This User Guide provides information to help you quickly set up your V123_V133. You can download this manual from the Hemisphere GNSS website at WWW.HGNSS.COM.

Contents

Topic	See Page
Product Overview	9
Key Features	13
What's Included in Your Kit	14
Using PocketMax4 to Communicate with the V123_V133	16
Firmware Upgrades	20

Product Overview

Product overview

The Vector V123_V133™ GNSS Compass supports GPS, GLONASS, Galileo, QZSS, and BeiDou satellites using Hemisphere GNSS' Crescent Vector H220™ GNSS module. This User Guide is available for download from www.HGNSS.com.

Note: When referring to both the Vector V123 and V133™ GNSS Compass, this manual uses the term V123_V133. When referring to either product this manual uses either V123 or V133, respectively.

The V123_V133 is designed for marine and land applications that require precise heading and sub-meter position performance. Featuring a Crescent Vector GNSS receiver and two separate antennas, V123_V133 achieves heading accuracy of 0.30° RMS.

The V123_V133 tracks single frequency GPS, GLONASS, Galileo, QZSS, and BeiDou. The V123_V133 can be upgraded via activations to support Atlas L-band.

The V123_V133 is a complete multi-GNSS compass system for heading and positioning in a single enclosure that requires only one power/data cable connection. With its CAN support and ease of installation, the V123_V133 is the perfect solution for professional, commercial marine, Radar/ARPA, AIS, ECDIS, scanning sonar and vessel control applications.

Continued on next page

Product Overview, Continued

Product overview continued

There are no mechanical parts such as gimbals or a rotating motor, thus the V123 and V133 Compass is free from routine maintenance. Heading is determined from GNSS, and there is no need to wait for settling time, gyrocompass calibration and speed corrections. Vector performance is not affected by geomagnetism, making it the perfect solution for any marine application.

The V123_V133 is an integrated system that houses the following:

- Crescent and Crescent Vector H220 module
- Dual GNSS multipath-resistant antennas
- DGPS beacon module and H-field beacon antenna (V133 only)
- Power supply
- Six-axis sensor

The sensor is present to improve system performance and to provide backup heading information in the event a GNSS heading is not available due to signal blockage. The sensor provides a substitute heading, accurate to within 1° per minute for up to three minutes.

The V133 has an internal Beacon antenna capable of receiving these signals, demodulating them, and applying the differential correction to the GNSS position

Note: Used as a heading device, the V123 GNSS Compass is identical to the V133 GNSS Compass. Used as a positioning device, only the V133 GNSS Compass contains a DGPS beacon module and antenna. If you purchased the V123 GNSS Compass, disregard the sections of this manual that discuss the beacon signal, receiver operation, and implications to installation relating to the beacon signal.

The Crescent Vector H220 module supports multiple RF front ends - enabling tighter coupling of measurements from separate antennas for use in heading-based products.

Continued on next page

Product Overview, Continued

Product overview, continued

The V123_V133's GPS antennas are separated by 50.0 cm between phase centers, resulting in a heading performance better than 0.30° RMS. The V123_V133 can provide heading and positioning updates of up to 50 Hz and delivers positioning accuracy of 0.6 m 95% of the time when using differential GPS corrections from Satellite Based Augmentation Systems (SBAS) or from beacon (V133 only).

The V123_V133 also features Hemisphere GNSS' exclusive Tracer™ technology, which enables Hemisphere GNSS receivers to use old differential GPS correction data for 40 minutes or more without significantly affecting the positioning quality. The V123_V133 is less likely to be affected by differential signal outages due to signal blockages, weak signals, or interference when using Tracer.

If you are new to GNSS and SBAS, refer to the [Hemisphere GNSS Technical Reference Manual](#) for further information on these services and technologies before proceeding.



Figure 1-1: V123_V133

Continued on next page

Product Overview, Continued

Atlas L-band

Atlas L-band is Hemisphere's industry leading correction service, which can be added to the V123_V133 as a subscription. Atlas L-band has the following benefits:

- **Positioning accuracy** - Competitive positioning accuracies down to 30 cm RMS in certain applications
 - **Positioning sustainability** - Cutting edge position quality maintenance in the absence of correction signals, using Hemisphere's patented technology
-

For more information

For more information about Athena RTK, see:

[HTTP://HGNS.COM/TECHNOLOGY](http://hgns.com/technology)

For more information about Atlas L-band, see:

[HTTP://HGNS.COM/ATLAS](http://hgns.com/atlas)

Key Features

V123_V133 Key features

Key features of the V123_V133 include:

- Sub-meter positioning
 - DGNS corrections from all SBAS constellations and over beacon
 - Position accuracies of 30 cm horizontal RMS without the need of a base station by using Atlas L-band* (*Requires the purchase of a subscription)
 - Heave of 30 cm RMS (DGNS)
 - Heading accuracy of 0.30° RMS
 - Pitch and roll < 1° RMS
 - Simple menu operations
 - 1 PPS output
 - Event marker input
 - 1 full-duplex RS232, 1 full-duplex RS422, and 1 half-duplex RS422 serial ports for NMEA 0183 output and serial configuration
 - Up to 50 Hz output
 - Accurate heading up to 3 minutes during GNSS outages
 - Integrated sensor delivers fast startup times and provide heading updates during temporary loss of GNSS
-

What's Included in Your Kit

V123_V133 kit Table 1-1 lists the parts included with your V123 or V133. The V123_V133 GNSS Compass and the power/data cable (accessory item) are the only two required components.

Note: The V123_V133's parts comply with IEC 60945 Section 4.4: "Exposed to the weather."

V123_V133 Parts list

Table 1-1 V123_V133 Parts list

Part No.	Description	Qty
940-3123-xx	Vector kit	
940-3131-xx	• Vector V123 GNSS Compass	
940-3124-xx	• Vector V123 GNSS Compass	
940-3124-xx	• Vector V133 GNSS Compass	
940-3132-xx	• Vector V133 GNSS Compass	
	Vector receiver model (one of the following models):	
804-0156-xx	• V123	1
804-0157-xx	• V133	1

Continued on next page

What's Included in Your Kit, Continued

V123_V133
Parts list,
 continued

All the following are accessory items available for purchase separately from your V123 or V133.

Part No.	Description	Qty
880-1042-000	Power/data cable, 15 m	1
880-1043-000	Power/data cable, 30 m Each cable includes: <ul style="list-style-type: none"> • Clamp • Screw • Washer 	1
710-0113-000#	Serial-to-NMEA 2000 adapter, includes the following items: <ul style="list-style-type: none"> • Screws • Washers 	1
602-1113-000#	Installation bracket (black)	1
400-0246-000#	Replacement connector, 18-pin	1

Using PocketMax4 to Communicate with the V123_V133

Using PocketMax4 to communicate with the V123_V133

First, power on and connect the receiver to your computer's com port. A configuration screen appears prompting you to choose the COM port and baud rate of the receiver.

Choose from the following communications settings options:

- Select COM Port.
- If you do not know the baud rate, select the **Auto-Baud** feature to cycle through all possible baud rates, and click **Connect**.

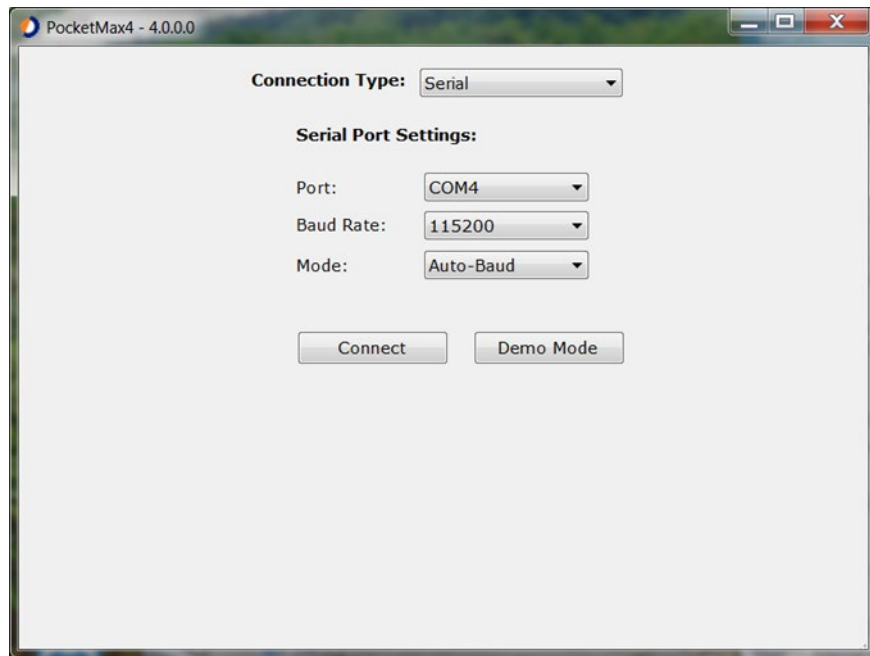

Continued on next page

Using PocketMax4 to Communicate with the V123_V133, Continued

Using
PocketMax4 to
communicate
with the
V123_V133,
continued

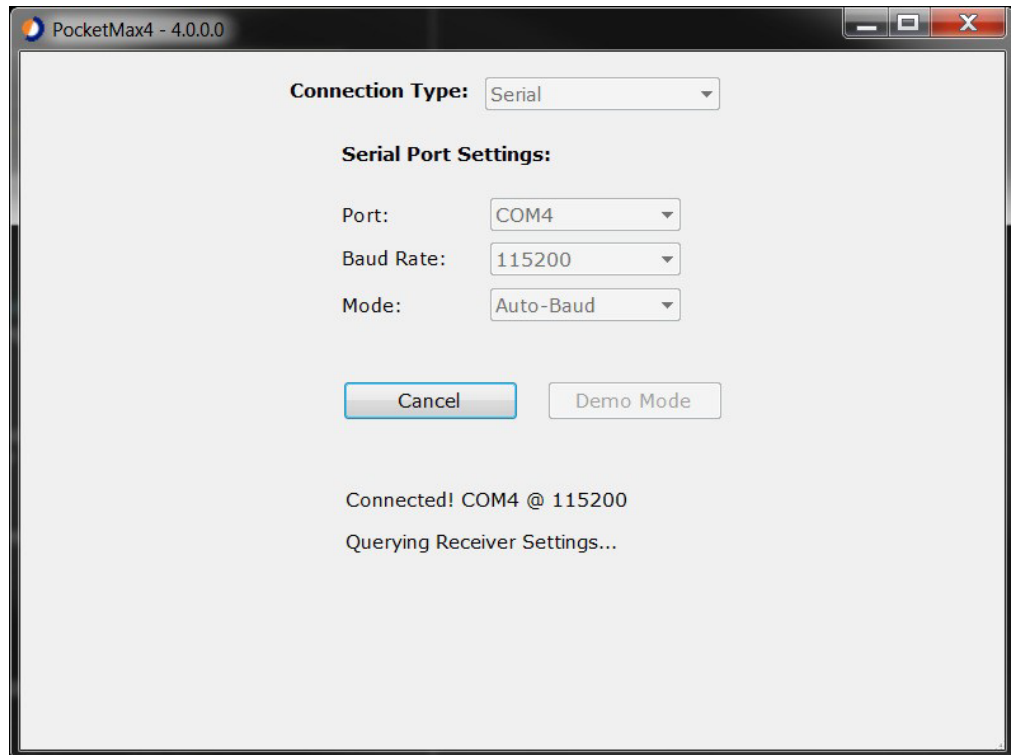

Continued on next page

Using PocketMax4 to Communicate with the V123_V133, Continued

Using
PocketMax4 to
communicate
with the
V123_V133,
continued

You can monitor your connection status through the message displayed at the bottom of the screen.

If you receive a message “Receiver not found...” check your connections, your com port, and your baud rate and try to re-send.

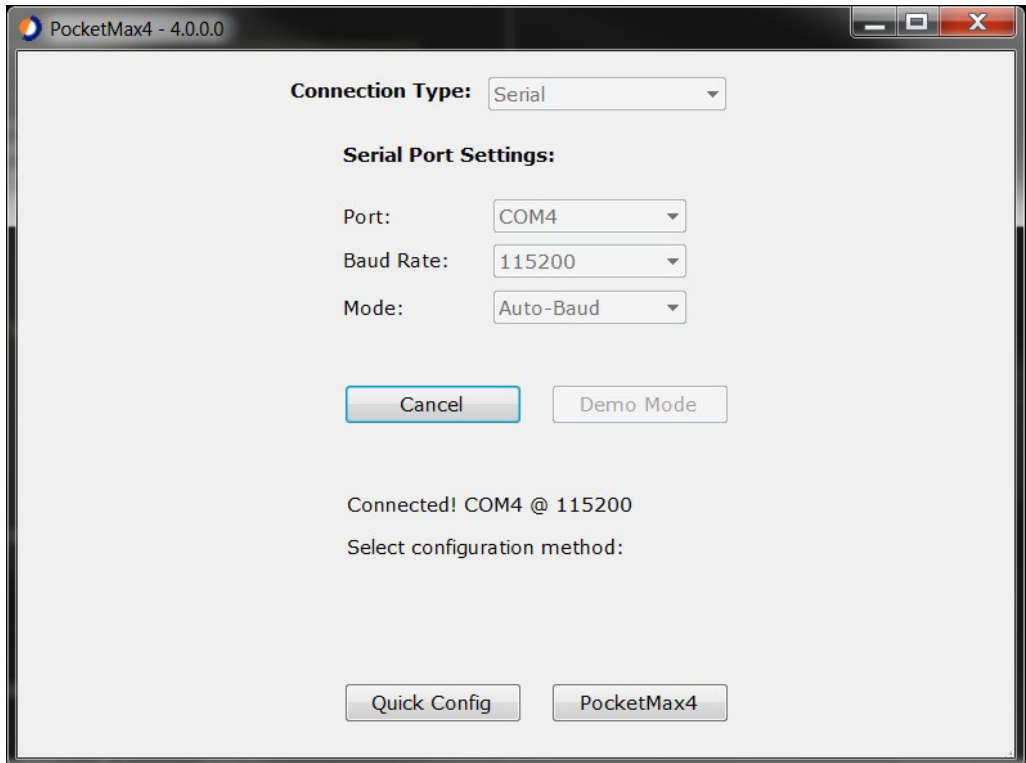

Continued on next page

Using PocketMax4 to Communicate with the V123_V133, Continued

Using PocketMax4 to communicate with the V123_V133, continued

The Quick Configuration screen allows you to use “PortA” and “PortB” tabs to configure the output messages and baud rates of these two ports.

The Port displaying “[THIS]” is the port currently connected. “[OTHER]” is the other port.

Enable all desired messages for PortA and PortB.

Use RxConfig to make basic receiver configurations. To exit the software, click Save Settings and Disconnect. For all other PocketMax4 questions, please reference the PocketMax4 User Guide on the [HGNS website](#).

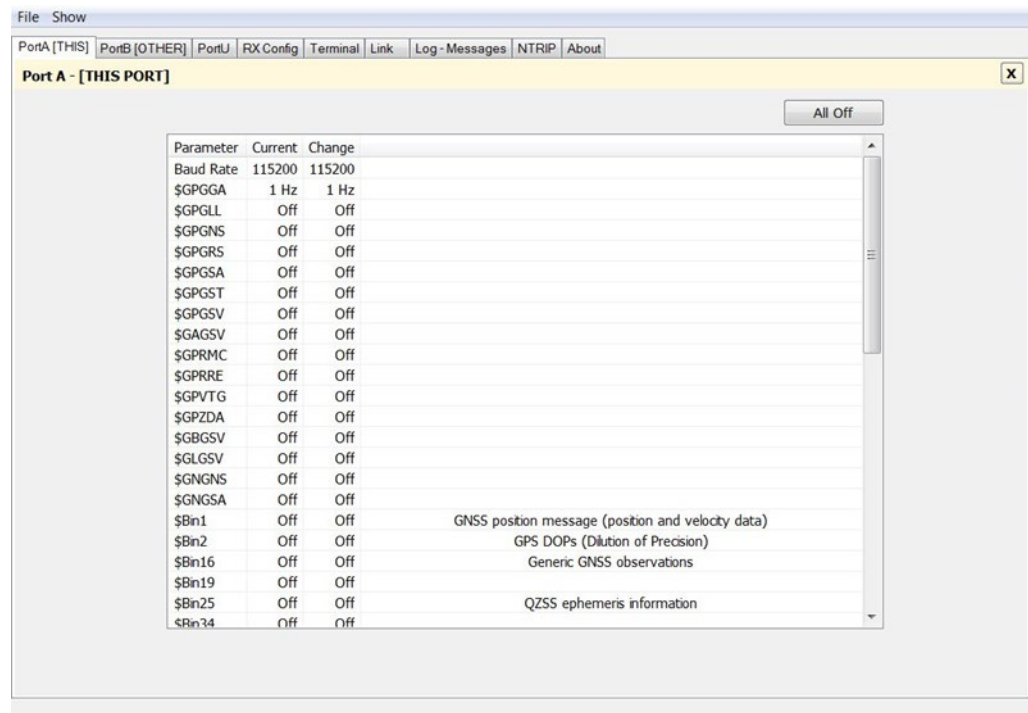

Firmware Upgrades

Overview

Periodically, Hemisphere GNSS releases firmware upgrades to improve performance, fix bugs, or add new features to a product. To update the firmware on the V123_V133:

1. Download the latest version of Hemisphere GNSS RightArm from the following link:

<HTTPS://HGNS.COM/RESOURCES-SUPPORT/SOFTWARE>.

RightArm updates

Connect the V123_V133 to a computer over serial. Firmware can be loaded over either serial port. Set the baud rate of the serial port you are using to 19200.

Launch RightArm.

Click the **Connect** button or navigate to Receiver -> Connect.



Continued on next page

Firmware Upgrades, Continued

RightArm
updates,
continued

Choose the COM port connected to the V123_V133 and click **OK**.

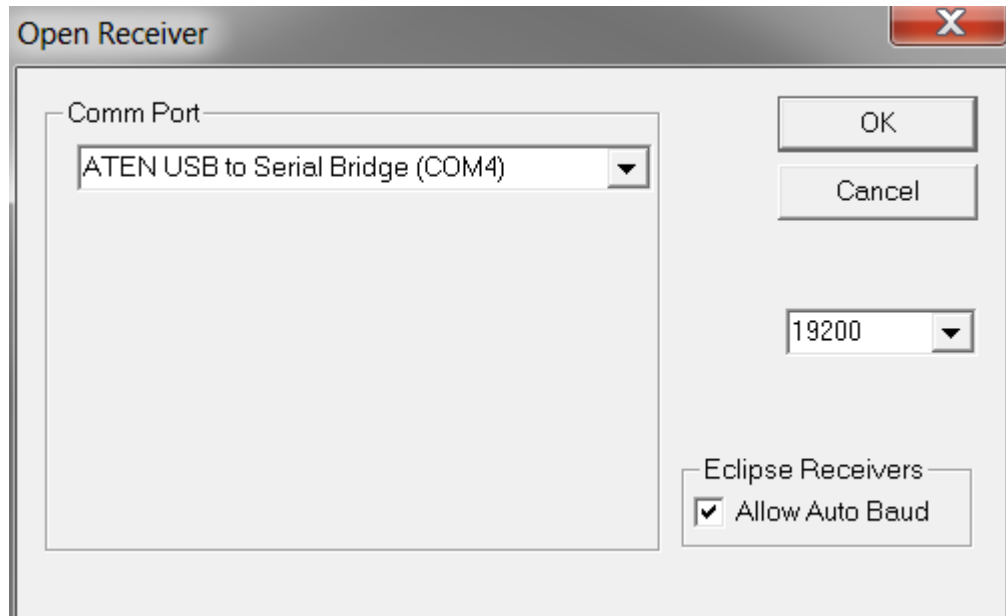

Note: The baud rate of the serial port should be set to 19200 bps. Select “Allow Auto Baud” to change the baud rate during the firmware upgrade for a faster update.

Continued on next page

Firmware Upgrades, Continued

RightArm
updates,
continued

Click the **Programming** button.

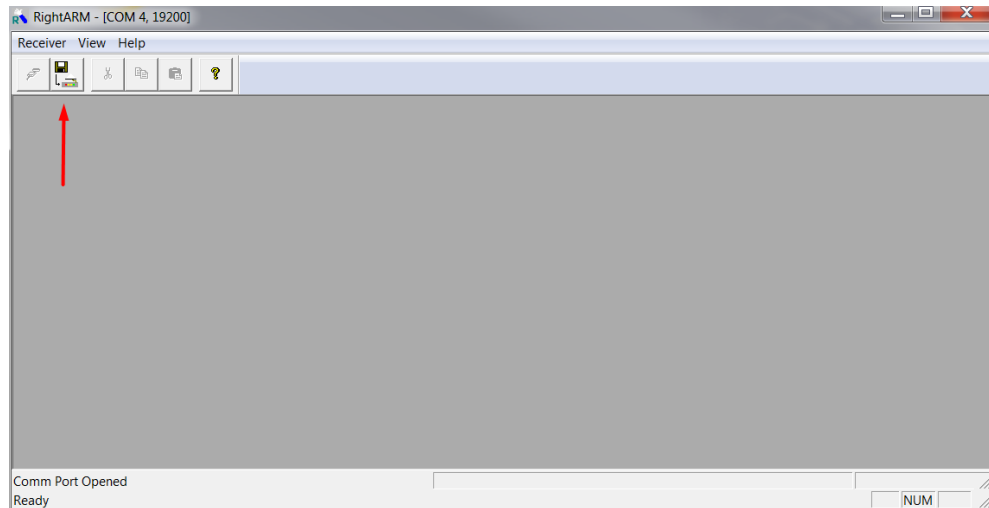

Select a **Program Type**.

The V123_V133 has two firmware applications, allowing two different versions of GNSS firmware. Hemisphere GNSS suggests loading the new firmware onto both applications.

After the firmware update is completed, check the current GNSS firmware.

If the current firmware is not the same as the newly loaded firmware, the V123_V133 could be using the other application. You can switch applications by sending the following command:

```
$JAPP,OTHER.
```

Choose the Application, and press **Select File** to select the firmware file.

Continued on next page

Firmware Upgrades, Continued

RightArm
updates,
continued

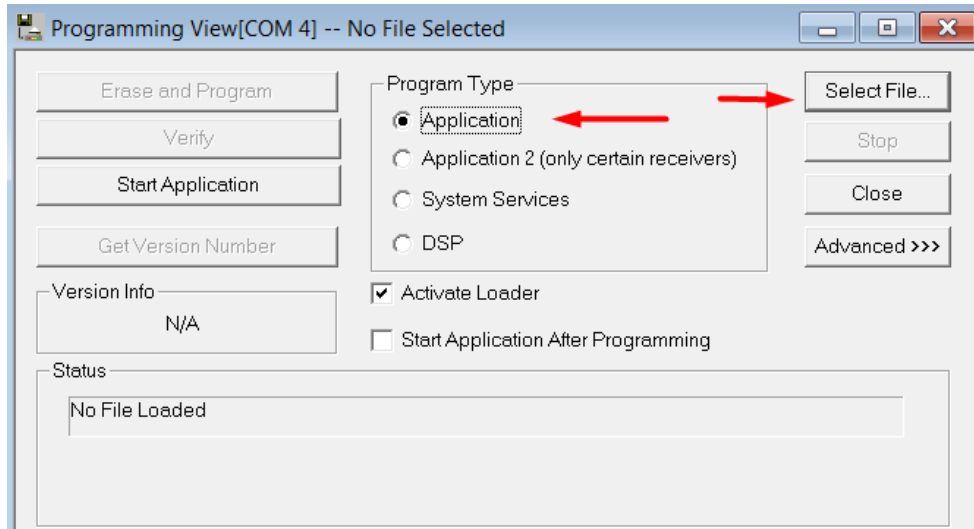

Choose the firmware, and click **Erase and Program**.

The **Activate Loader** checkbox in the Programming View window is selected. After pressing the Erase and Program button, this checkbox will de-select, and the **Status** field indicates the receiver is in loader mode (ready to receive the new firmware file).

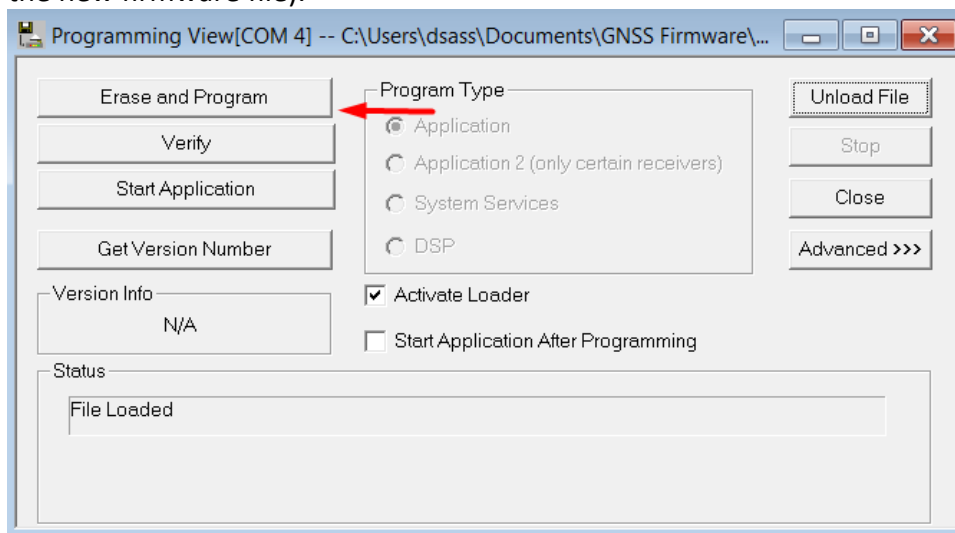

Continued on next page

Firmware Upgrades, Continued

RightArm updates,
continued

Note: If the Activate Loader check box remains selected, power the receiver off and on. When the receiver powers back on, the Activate Loader box should be de-selected.

⚠ WARNING:

Do not to interrupt the power supply to the receiver, and do not interrupt the communication link between the PC and the receiver until programming is complete. Failure to do so may cause the receiver to become inoperable and will require factory repair.

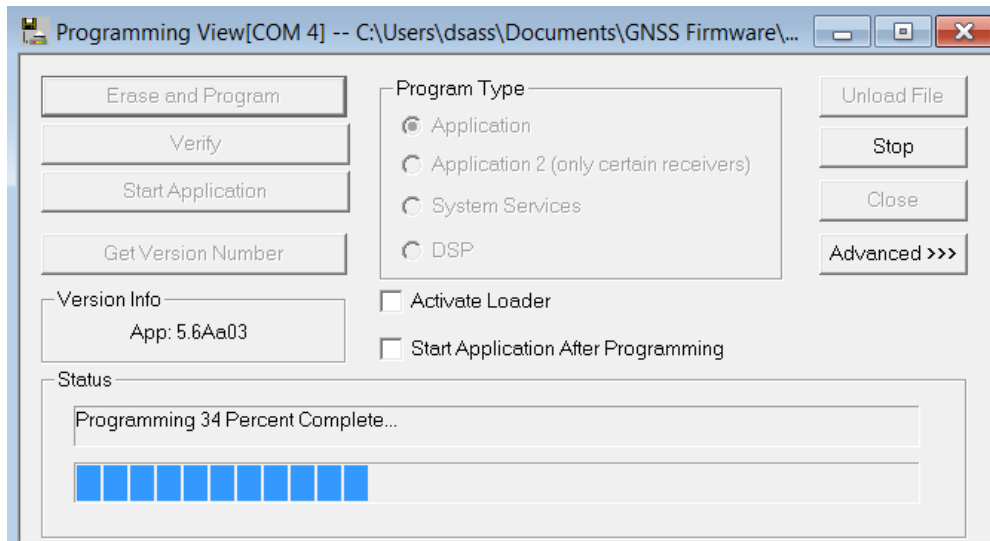

Note: After completing the firmware update, Hemisphere GNSS suggests repeating this process for the other application.

Chapter 2: Installing the V123_V133

Overview

Introduction This chapter provides instructions on how to mount and install your V123_V133 receiver.

Contents

Topic	See Page
Mounting the V123_V133	26
Ports	43
Selecting Baud Rates and Message Types	45
Connecting the V123_V133 to External Devices	46

Mounting the V123_V133

Introduction

This section provides information on mounting the V123_V133 in the optimal location, orientation considerations, environmental considerations, and other mounting options.

GNSS satellite reception

When considering where to mount the V123_V133, consider the following satellite reception recommendations:

- Ensure there is a clear view of the sky available to the V123_V133 so the GNSS and L-band satellites are not masked by obstructions that may reduce system performance
- Mount the V123_V133 in a position in respect to the primary GNSS antenna (located on the end opposite the recessed arrow on the underside of the enclosure)
- Locate any transmitting antennas away from the V123_V133 by at least a few meters to ensure tracking performance is not compromised
- Ensure cable length is adequate to route into the vessel to reach a breakout box or terminal strip
- Do not locate the antenna where environmental conditions exceed those specified in [Appendix B, Technical Specifications](#) of this document.

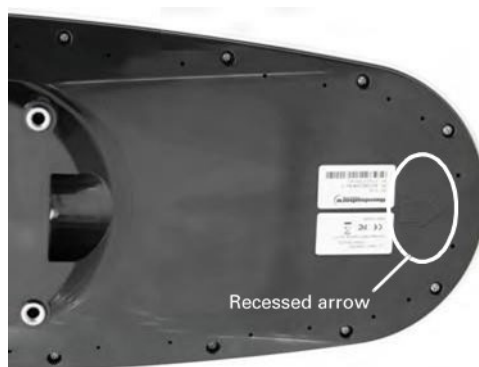

Figure 2-1: Recessed arrow

Continued on next page

Mounting the V123_V133, Continued

Beacon reception

When using the V133's internal beacon receiver as the correction source, consider the possible mounting locations from the perspective of ambient noise within the beacon band.

Keep the following in mind when deciding upon a location with respect to maximizing beacon performance:

- Ensure that the antenna is as far as possible from all other equipment that emits electromagnetic interference (EMI), including DC motors, alternators, solenoids, radios, power cables, display units, and other electronic devices.
- If you are installing the antenna on a vessel, mount the Vector compass as high as possible, considering maintenance and accessibility. In addition, ensure that the antenna is higher than the highest metal object on the vessel.
- If a radar system is present, mount the antenna outside the path of the radar beam.

The V133's internal beacon receiver calculates a signal-to-noise ratio (SNR), measured in decibels (dB), that indicates the receiver's performance. The SNR is the height of the signal above the noise floor: the higher the SNR, the better your beacon receiver demodulates the signal.

The optimum antenna location is a position where your average SNR is highest. You should turn on all accessories you intend to use during normal operation when locating the best position for the antenna. By monitoring the SNR, you can determine the optimum location with respect to beacon reception. The SNR is available in the \$CRMSS NMEA message described in the [Hemisphere GNSS Technical Reference Manual](#).

Continued on next page

Mounting the V123_V133, Continued

VHF interference

VHF interference from such devices as cellular phones and radio transmitters may interfere with GPS operation, however the Vector compass can still track other constellations, maintaining heading and position.

For example, if installing the V123_V133 near marine radios, consider the following:

- VHF marine radio working frequencies (Channels 1 to 28 and 84 to 88) range from 156.05 to 157.40 MHz. The L1 GPS working center frequency is 1575.42 MHz. The bandwidth is +/- 2MHz to +/- 10 MHz, which is dependent on the GNSS antenna and receiver design.
- VHF marine radios emit strong harmonics. The 10th harmonic of VHF radio, in some channels, falls into the GPS working frequency band, which may cause the SNR of GNSS to degrade significantly.
- The radiated harmonic signal strength of different brands/models varies.
- Follow VHF radio manufacturers' recommendations on how to mount their radios and what devices to keep a safe distance away.
- Handheld 5W VHF radios may not provide suitable filtering and may interfere with the V123_V133's operation if too close.

Before installing the Vector Compass, use the following diagram to ensure there are no nearby devices that may cause VHF interference.

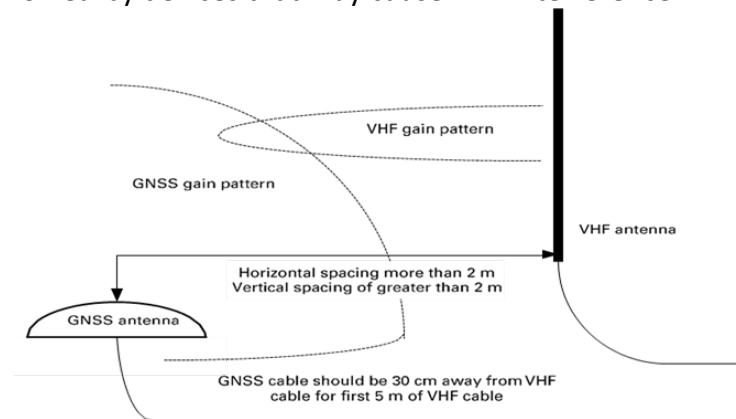

Figure 2-2: V123_V133 distance from nearby VHF radios

Continued on next page

Mounting the V123_V133, Continued

Environmental considerations

Hemisphere Vector Smart Antennas are designed to withstand harsh environmental conditions; however, adhere to the following limits when storing and using the V123_V133:

- Operating temperature: -30°C to +70°C (-22°F to +158°F)
 - Storage temperature: -40°C to +85°C (-40°F to +185°F)
 - Humidity: 95% non-condensing
-

Mounting orientation

The V123_V133 outputs heading, pitch, and roll readings regardless of the orientation of the antennas. The relation of the antennas to the vessel's axis determines if you need to enter a heading, pitch, or roll bias.

The primary antenna is used for positioning and the primary and secondary antennas, working in conjunction, output heading, pitch, and roll values.

Note: Regardless of which mounting orientation you use, the V123_V133 provides the ability to output the heave of the vessel. This output is available via the \$GPHEV message. For more information on this message refer to the [Hemisphere GNSS Technical Reference Manual](#).

Parallel orientation

Parallel installation orients the V123_V133 parallel to, and along the centerline of, the axis of the vessel. **This provides a true heading.** In this orientation:

- If you use a gyrocompass and there is a need to align the Vector smart antenna, you can enter a heading bias in the V123_V133 to calibrate the physical heading to the true heading of the vessel.
 - You may need to adjust the pitch/roll output to calibrate the measurement if the Vector is not installed in a horizontal plane.
-

Continued on next page

Mounting the V123_V133, Continued

Perpendicular orientation

You can also install the antennae, so they are oriented perpendicular to the centerline of the vessel's axis. In this orientation:

- Enter a heading bias of $+90^\circ$ if the primary antenna is on the starboard side of the vessel and -90° if the primary antenna is on the port side of the vessel.
- Configure the receiver to specify the GNSS smart antenna is measuring the roll axis using `$JATT,ROLL,YES`.
- Enter a roll bias to properly output the pitch and roll values.
- You may need to adjust the pitch/roll output to calibrate the measurement if the Vector is not installed in a horizontal plane.

Mounting orientation example

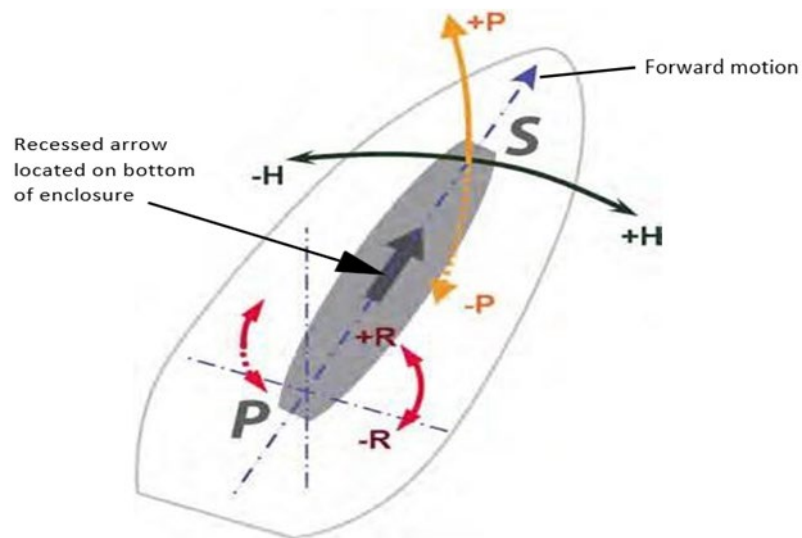

Figure 2-3: Recommended orientation and resulting signs of HPR values

Continued on next page

Mounting the V123_V133, Continued

Mounting orientation example, continued

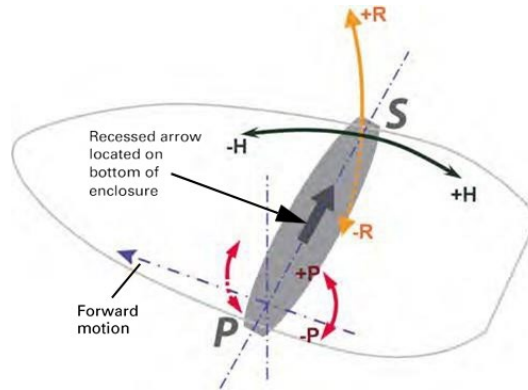

Figure 2-4: Alternate orientation and resulting signs of HPR values

Mounting alignment

The top of the V123_V133 enclosure incorporates sight design features to help you align the enclosure on your vessel.

To use the sights, center the small post on the opposite side of the enclosure from you, within the channel made in the medallion located in the center of the enclosure top as shown in Figure 2-5 and Figure 2-6.

Alignment accuracy when looking through the long site (Figure 2-5) is approximately $\pm 1^\circ$, while alignment through the short site (Figure 2-6) is approximately $\pm 2.5^\circ$.



Figure 2-5: Long site alignment

Continued on next page

Mounting the V123_V133, Continued

Mounting alignment, continued



Figure 2-6: Short site alignment

If you have another accurate source of heading data on your vessel, such as a gyrocompass, you may use its data to correct for a bias in V123_V133 alignment within the V123_V133 software configuration.

Alternatively, you can physically adjust the heading of the V123_V133 so that it renders the correct heading measurement or add a software offset.

Mounting options

The V123_V133 allows for three different mounting options: flush-mount, pole-mount, and bracket-mount:

1. **Flush-mount** - The bottom of the V123_V133 contains eight M8-1.25 holes for flush mounting the unit to a flat surface (see Figure 2-7). The eight holes comprise two sets of four holes. Flush mounting does not provide any additional dampening to the receiver. The V123_V133 can be mounted using an optional mounting bracket. See Table 1-1 for bracket part information.
2. **Pole-mount** - The V123_V133 can be mounted using a mounting pole. The set screws on the long sides of the base (see middle drawing in Figure 2-7) allow you to secure the V123_V133 in place (3/16" Allen wrench not included). **Hand tighten until snug (do not overtighten).**
3. **Bracket-mount** - You can purchase an optional mounting bracket. See Table 1-1 for bracket part information.

Note: Hemisphere GNSS does not supply mounting surface hardware or a mounting pole. You must supply the appropriate mounting hardware required to complete V123_V133 installation.

Continued on next page

Mounting the V123_V133, Continued

V123_V133 dimensions

Figure 2-7 illustrates the physical dimensions of the V123_V133.

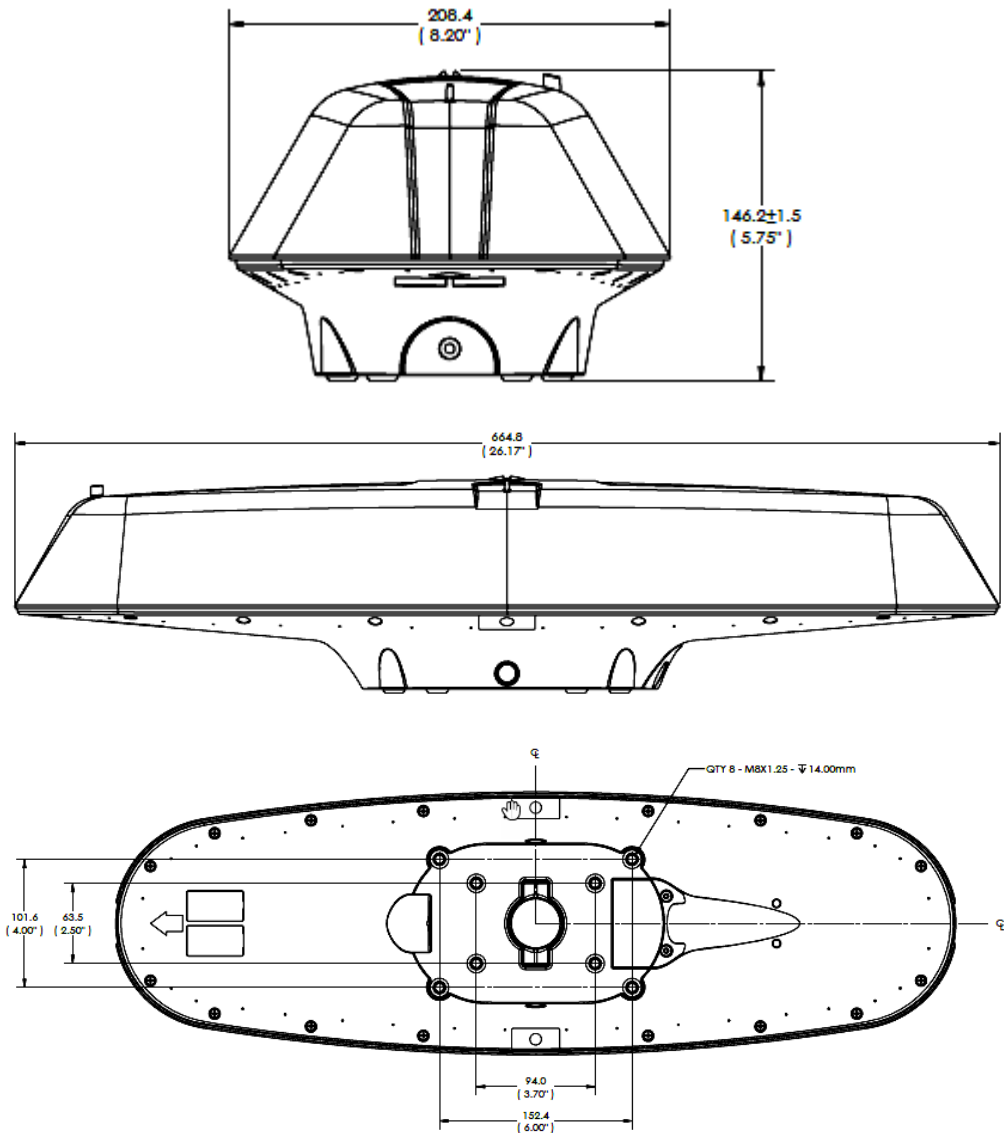

Figure 2-7: V123_V133 dimensions

Continued on next page

Mounting the V123_V133, Continued

**Power/data
cable
considerations**

Before mounting the V123_V133, consider the following regarding power/data cable routing:

Do	Do not
Ensure cable reaches appropriate power source	Run cables in areas of excessive heat
Keep cable away from corrosive chemicals	Run cables through a door or window jams
Connect to a data storage device, computer, or other device that accepts GNSS data	Crimp or excessively bend the cable
Keep cable away from rotating machinery	Place tension on the cable
Remove unwanted slack from the cable at the V123_V133 end	
Secure along the cable route using plastic wrapping	

⚠ WARNING:
Improperly installed cable near machinery can be dangerous.

Continued on next page

Mounting the V123_V133, Continued

Connecting the serial power/data cable

Step	Action
1	Align the cable connector key-way with the V123_V133 connector key.
2	Rotate the cable ring clockwise until it locks. The locking action is firm; you will feel a positive “click” when it has locked.
3	Attach the power/data cable to the cable clamp.
4	Fasten the clamp to the bottom of the V123_V133 using the screw and washer.
5	Attach the cable cover.



Steps 1&2:
Attach cable
to unit

Connect cable here



Cable ring

Cable connector
keyway



V123/133
connector key

Continued on next page

Mounting the V123_V133, Continued

Connecting the serial power/data cable, continued

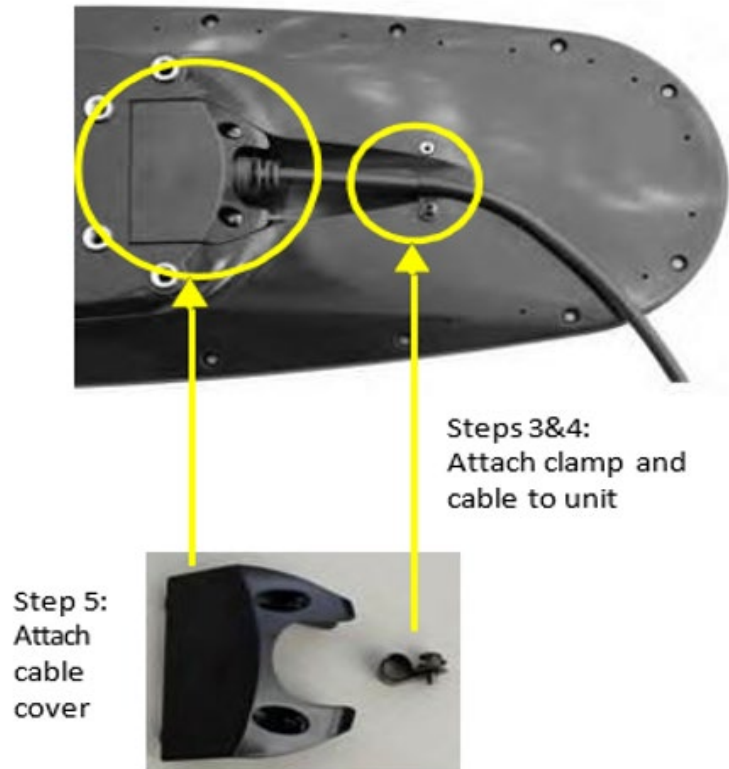

Figure 2-8: Connecting the serial power/data cable

Continued on next page

Mounting the V123_V133, Continued

Connecting to the serial-to-NMEA 2000 adapter

After you mount the V123_V133, connect either the serial power/data cable, or the serial-to-NMEA 2000 adapter to the V123_V133.

Step	Action
1	Align the adapter connector keyway with the V123_V133 connector key.
2	Rotate the cable ring clockwise until it locks. The locking action is firm; you will feel a positive “click” when it has locked.
3	Fasten the adapter to the body of the V123_V133 using the provided screws and the two slots in the adapter.
4	Attach the cable cover.

Note: For more information on the serial-to-NMEA 2000 adapter see [“NMEA 2000 Port”](#).

Continued on next page

Mounting the V123_V133, Continued

Connecting to
the serial-to
NMEA 2000
adapter,
continued

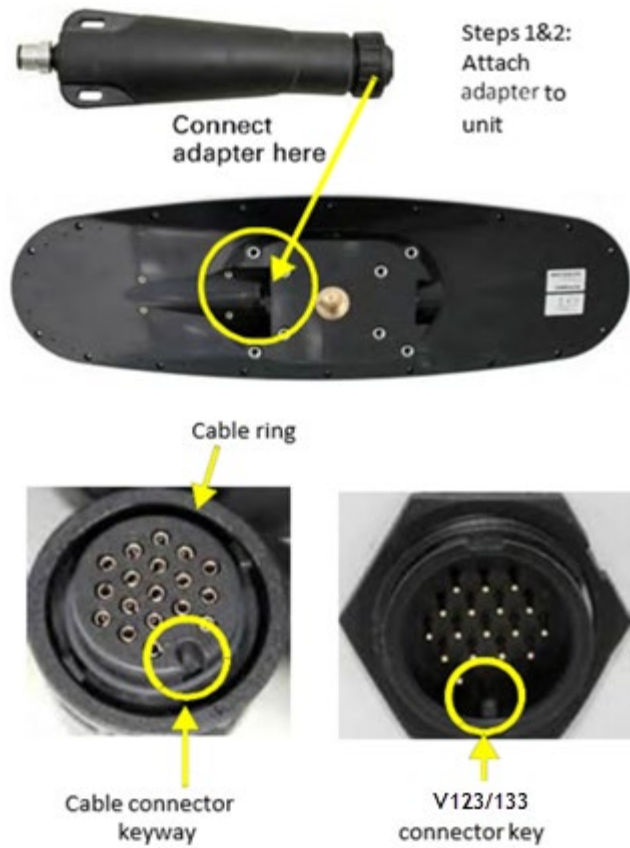

Continued on next page

Mounting the V123_V133, Continued

Connecting to the serial-to-NMEA 2000 adapter, continued



Figure 2-9: Connecting to the serial-to-NMEA 2000 adapter

Continued on next page

Mounting the V123_V133, Continued

Flush-mounting the V123_V133

This section describes how to flush-mount or pole-mount the V123_V133.

Be mindful of the following when planning your installation:

- Hemisphere GNSS does not supply mounting surface hardware or a mounting pole. You must supply the appropriate hardware or mounting pole required to complete V123_V133 installation.
- You can enter a software offset to accommodate for a heading measurement bias due to installation.

The bottom of the V123_V133 contains eight holes (two sets of four holes) for flush-mounting the unit to a flat surface (Figure 2-10).

The flat surface may be fabricated per your installation, an off-the-shelf item (such as a radar mounting plate), or an existing surface on your vessel.



Figure 2-10: Flush-mounting holes on bottom of V123_V133

Note: For flush mounting the V123_V133, refer to the dimensions drawing for mounting specifications.

Continued on next page

Mounting the V123_V133, Continued

Flush-mounting
the V123_V133,
continued

Complete the following steps to mount the V123_V133:	
Step	Action
1	Determine the desired location and proper orientation for the V123_V133. See “ Mounting Orientation ” for information on determining the desired orientation.
2	Navigate to the HGNSS website Home / Products / Products / Position & Heading / Vector V123&V133 Smart Antenna
3	Use the supplied drawing or photocopy the section of the V123_V133 that contains the eight mounting for use as a template to plan the mounting hole locations. Use the inner four holes or the outer four holes per your installation.
4	If using a photocopy, make sure it is scaled one-to-one with the mounting holes on the bottom of the V123_V133.
5	Mark the mounting hole centers on the mounting surface.
6	Place the V123_V133 over the marks to ensure the planned hole centers align with the true hole centers (adjusting as necessary).
7	Use a center punch to mark the hole centers.
8	Drill the mounting holes with a 9mm bit appropriate for the surface.
9	Place the V123_V133 over the mounting holes and insert the mounting screws through the bottom of the mounting surface into the V123_V133.
<p>⚠ WARNING:</p> <p>When installing the V123_V133, hand-tighten to no more than 20 lbf.in. Damage resulting from overtightening is not covered by the warranty.</p>	

Continued on next page

Mounting the V123_V133, Continued

Pole-mounting the V123_V133

If you need the GNSS-assisted roll measurement, install the V123_V133 perpendicular to the vessel's axis. If you do not need this measurement, install the V123_V133 parallel with the vessel's axis.

Complete the following steps to pole-mount the V123_V133:

Step	Action
1	Determine the desired location and proper orientation for the V123_V133. See " Mounting Orientation " for information on determining the desired orientation.
2	Hand tighten the V123_V133 on the pole until snug (unit is stable on pole) while ensuring correct orientation. <div style="border: 1px solid black; padding: 5px; margin-top: 10px;"> <p>⚠ WARNING: Hand tighten to no more than 20 lbf.in. Damage resulting from over-tightening is not covered by the warranty.</p> </div>
3	Use the set screws on the long sides of the base to secure the V123_V133 in place (3/16" Allen wrench not included).

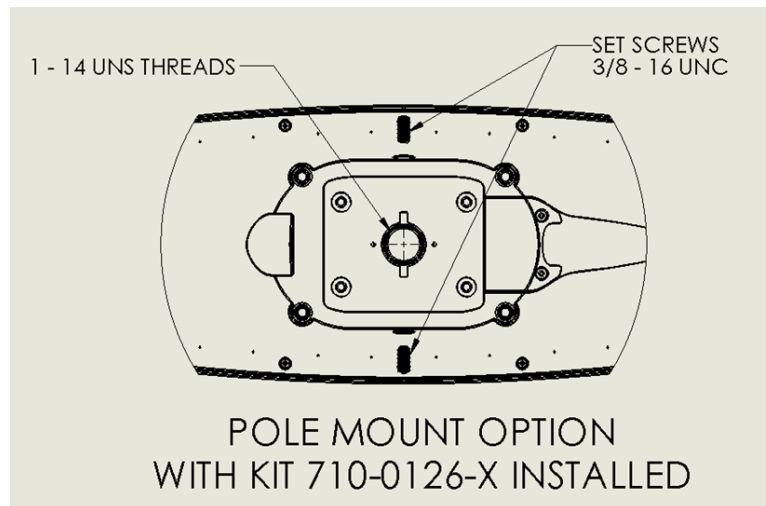

Figure 2-11: Pole-mounting specifications

Ports

Overview The V123_V133 offers either serial port or NMEA 2000 functionality.

Serial ports The V123_V133 has three serial ports:

1. Port A can be both full-duplex RS-232 and half-duplex RS-422 (transmit only)
2. Port B is full-duplex RS-422
3. Port C is for NMEA 2000 and only available via serial-to-NMEA adapter

You can receive external differential corrections via either Port A (full-duplex RS-232) or Port B (full-duplex RS-422).

You can connect up to three devices at one time using two ports.

One device can receive data via Port A (RS-422 transmit only) while two devices can transmit and receive data via Ports A and B (one connected to Port A RS-232 and one connected to Port B).

You can update firmware via Port A (RS-232) or Port B.

Note: The V123_V133 has maximum baud rate of 115200.

Continued on next page

Ports, Continued

Serial port configuration

You may configure Port A or Port B of the GNSS receiver to output any combination of data.

Port A can have a different configuration from Port B in data message output, data rates, and the baud rate of the port, and configure the ports independently based upon your needs. Both RS-232 and RS-422 output signals may be used simultaneously.

The RS-232 Port A and RS-422 Port A output the same data messages at the same baud rate. If the baud rate or messages for the RS-422 port need to be changed, this needs to be commanded through the RS-232 port.

Note: For successful communications, use the 8-N-1 protocol and set the baud rate of the V123_V133's serial ports to match that of the devices to which they are connected. Flow control is not supported.

Selecting Baud Rates and Message Types

Baud rates & Message types

When selecting your baud rate and message types, use the following formula to calculate the bits/sec for each message and sum the results to determine the baud rate for your required data throughput.

Message output rate * Message length (bytes) * bits in byte = Bits/second
(1 character = 1 byte, 8 bits = 1 byte, use 10 bits/byte to account for overhead).

For information on message output rates refer to the [Hemisphere GNSS Technical Reference Manual](#).

NMEA 2000 port

To use the V123_V133 for NMEA 2000, connect the included serial-to-NMEA 2000 adapter (P/N 710-0113-000#, see Figure 2-12) to the unit. Insert the 18-pin connector of the adapter into the male end of the 18-pin connector on the V123_V133 by aligning the keys.

Attach the adapter to the unit using the supplied screws (machine, 8-32, 1/2", PPHC, SS) and washer (flat, #8, SS). The 5-pin male Micro-C connector connects to your NMEA 2000 drop cable.



Figure 2-12: Serial-to-NMEA adapter

Connecting the V123_V133 to External Devices

Recommendations for connecting to other devices

When interfacing with other devices, ensure the transmit data output and the signal grounds from the V123_V133 is connected to the data input of the other device. The signal grounds must also be connected.

The RS-422 is a balanced signal with positive and negative signals referenced to ground, ensure you maintain the correct polarity.

When connecting the transmit data output positive signal to the receive line of the other device, it should be connected to the receive positive terminal.

The negative transmit data signal from the V123_V133 is connected to the receive data negative input of the other device.

For a list of Hemisphere GNSS commands, please refer to the [Hemisphere GNSS Technical Reference Manual](#).

Power/data cable considerations

The V123_V133 uses a single 15 m (49 ft) or 30 m (98 ft) cable for power and data input/output.

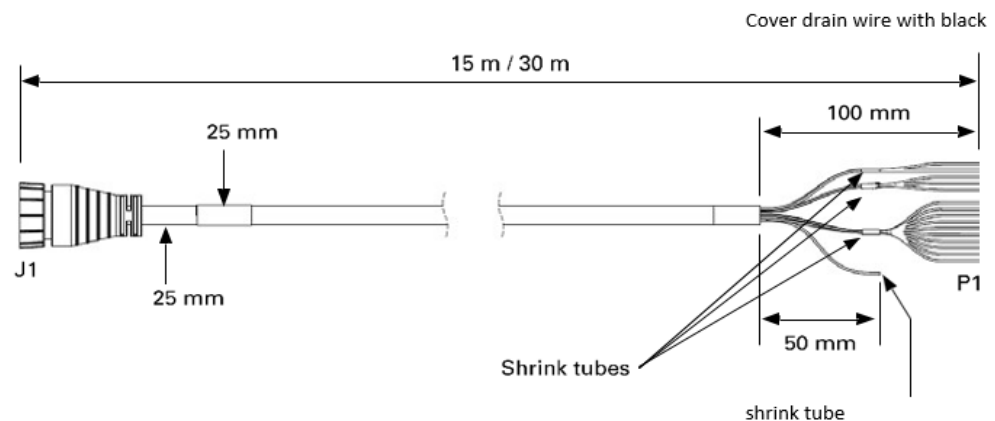

Figure 2-13: Power/data cable

Note: Cover drain wire with black shrink tube.

Continued on next page

Connecting the V123_V133 to External Devices, Continued

Power/data cable considerations, continued

The receiver end of the cable is terminated with an environmentally-sealed 18-pin connection while the opposite end is unterminated and requires field stripping and tinning.

Note: This section refers to a serial connection. For connecting external NMEA 2000 devices, plug the serial-to-NMEA 2000 adapter into the V123_V133 and then attach a standard NMEA 2000 dropline cable to the adapter.

Power/data cable pin-out assignments

Depending on the application and installation needs, the cable may need to be shortened. However, if you require a longer cable run than 30 m, you can bring the cable into a break-out box that incorporates terminal strips, within the vessel.

When lengthening the cable keep the following in mind:

- To lengthen the serial lines inside the vessel, use 20-gauge twisted pairs and minimize the additional wire length.
- When lengthening the power input leads to the V123_V133, ensure the additional voltage drop is small enough to power the system above the minimum voltage of the system. Wire of 18-gauge or larger should also be used.
- Minimize RS-232 cable length to ensure reliable communication.

Figure 2-14 shows the power/data cable pin-out assignments.

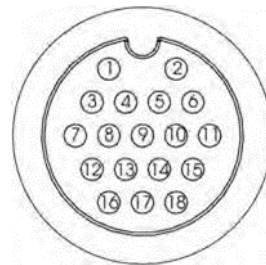

Figure 2-14: V123_V133 pin-out assignments

Continued on next page

Connecting the V123_V133 to External Devices, Continued

Power/data
cable pin-out
specifications

Table 2-1 shows the cable pin-out specifications.

Table 2-1: V123_V133 pin-out specifications

Pin	Signal	Color
1	Power (+)	Red
2	Power (-)	Black
3	Port A Tx RS-232	Blue
4	Port A Rx RS-232	Black/blue stripe
5	Reserved	
6	Port A Tx RS-422(+)	Green
7	Port B Rx RS-422(+)	Brown
8	Port B Rx RS-422(-)	Black/brown stripe
9	Reserved	
10	Drain	Bare wire
11	Port A Tx RS-422(-)	Green/black stripe
12	Signal ground	Grey
13	Alarm	White
14	Alarm	White/red stripe
15	1 PPS(+)	Orange
16	Port B Tx RS-422(+)	Yellow
17	Port B Tx RS-422(-)	Yellow/black stripe
18	1 PPS(-)	Orange/black stripe

Chapter 3: Understanding the V123_V133

Overview

Introduction

The GNSS receiver begins tracking satellites when it powers up and is placed outside in an open area. Position and heading accuracy vary depending upon location and environment. Position performance can be improved with RTK or DGNSS.

The following sections provide the steps to configure your V123_V133 to use Atlas, Beacon, SBAS, or RTK.

Note: Differential source and RTK status impact only positioning and heave. There is no impact to heading, pitch, or roll.

Contents

Topic	See Page
Differential Operation	50
SBAS Tracking	50
GNSS Overview	51
Atlas L-band	52
Supplemental Sensors	53
Time Constants	56

Differential Operation

Differential (DGNSS) operation

The V123_V133 delivers positioning accuracies of 2.5 m 95% and provides positioning quality to better than 0.6 m 95% using differential corrections received through the internal SBAS demodulator, beacon receiver, Atlas L-band, or through externally-supplied RTCM corrections.

SBAS Tracking

SBAS tracking

The V123_V133 features two-channel tracking that provides an enhanced ability to maintain a lock on an SBAS satellite when more than one satellite is in view. This redundant tracking approach results in more consistent tracking of an SBAS signal in areas where signal blockage of a satellite is possible.

GNSS Overview

GNSS operation The GNSS receiver is always operating, regardless of the DGNSS mode of operation. The following sections describe the general operation of the V123_V133's internal GNSS receiver.

Note: Differential source and status have no impact on heading, pitch, or roll. They only have an impact on positioning and heave.

The V123_V133 provides accurate and reliable heading and position information at high update rates. To accomplish this task, the V123_V133 uses a high performance GNSS receiver and two antennas for GNSS signal processing.

One antenna is designated as the primary GNSS antenna and the other is the secondary GNSS antenna. Positions computed by the V123_V133 are referenced to the phase center of the primary GNSS antenna. Heading data references the Vector formed from the primary GNSS antenna phase center to the secondary GNSS antenna phase center.

The heading arrow located on the bottom of the V123_V133 enclosure defines system orientation. The arrow points in the direction the heading measurement is computed (when the antenna is installed parallel to the fore-aft line of the vessel). The secondary antenna is directly above the arrow.

Atlas L-band

Atlas L-band

Atlas L-band corrections are available worldwide. With Atlas, the positioning accuracy does not degrade as a function of distance to a base station, as the data content is not composed of a single base station's information, but an entire network's information.

The V123_V133 can calculate a position with 30 cm RMS (horizontal) accuracy.

To configure the receiver to use Atlas L-band, a subscription must be purchased.

Supplemental Sensors

Overview

The V123_V133 has a supplemental sensor integrated into the H220 GNSS board that is enabled by default. You can enable/disable the sensor.

The sensor acts to reduce the RTK search volume, which improves heading startup and reacquisition times. This improves the reliability and accuracy of selecting the correct heading solution by eliminating other possible, erroneous solutions.

The [Hemisphere GNSS Technical Reference Manual](#) describes the commands and methodology required to recalibrate, query, or change the sensor status.

Tilt aiding

The V123_V133's internal sensor is factory calibrated and enabled by default and constrains the RTK heading solution beyond the volume associated with a fixed antenna separation.

The V123_V133 knows the approximate inclination of the secondary antenna with respect to the primary antenna. The search space defined by the sensor is reduced to a horizontal ring on the sphere's surface by reducing the search volume and decreases startup and reacquisition times (see Figure 3-1).

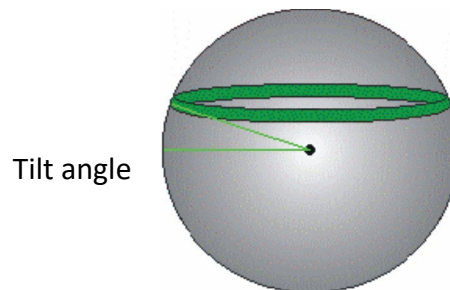

Figure 3-1: V123_V133 tilt aiding

Continued on next page

Supplemental Sensors, Continued

Gyro aiding

The V123_V133's internal sensor reduces reacquisition times when a GNSS heading is lost due to blocked satellite signals.

The sensor provides a relative change in angle since the last computed heading and defines the search space as a wedge-shaped location (see Figure 3-2).

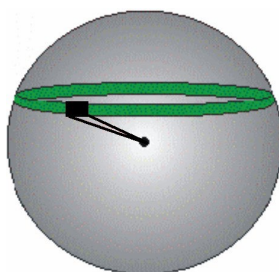

Figure 3-2: V123_V133 gyro aiding

The gyro aiding accurately smooths the heading output and the ROT. The sensor also provides an alternate source of heading, accurate to within 1° per minute for up to three minutes in times of GNSS loss for either antenna. If the outage lasts longer than three minutes, the sensor will have drifted too far and the V123_V133 begins outputting null fields in the heading output messages. There is no user control over the timeout period of the sensor.

The sensor initializes itself at power up and during initialization, or you can calibrate it as outlined in the [Hemisphere GNSS Technical Reference Manual](#).

For optimal performance, when the sensor is first initializing, the dynamics the sensor experiences during this warm-up period are similar to the regular operating dynamics.

Continued on next page

Supplemental Sensors, Continued

Gyro aiding,
continued

Gyro-aiding updates the post HTAU-smoothed heading. As a result, if the HTAU value is increased while gyro aiding is enabled, there will be little to no lag in heading output due to vessel maneuvers.

The [Hemisphere GNSS Technical Reference Manual](#) includes information on setting an appropriate HTAU value for the application.

Time Constants

Overview

The V123_V133 incorporates user-configurable time constants that can provide a degree of smoothing to the heading, pitch, Rate-of-Turn (ROT), Course-over-Ground (COG), and speed measurements.

You can adjust these parameters depending on the expected dynamics of the vessel. For example, increasing the time is reasonable if the vessel is very large and is not able to turn quickly or would not pitch quickly. The resulting values would have reduced “noise,” resulting in consistent values with time.

If the vessel is quick and nimble, increasing this value can create a lag in measurements.

If you are unsure on how to set this value, it is best to be conservative and leave it at the default setting.

Note: For heading and rate of turn there is no lag once the sensor is calibrated and enabled.

Formulas for determining the level of smoothing are located in the [Hemisphere GNSS Technical Reference Manual](#). If you are unsure how to set this value, it is best to be conservative and leave the default setting.

Heading

Use the \$JATT,HTAU command to adjust the level of responsiveness of the true heading measurement provided in the \$GPHDT message. The default value of this constant is 0.1 seconds of smoothing when gyro-aid is enabled.

By disabling gyro-aid, the equivalent default value of the heading time constant should be 0.5 seconds of smoothing. This is not automatic, and therefore it must be manually entered.

Note: Increasing the time constant increases the level of heading smoothing and increases lag (with gyro-aid disabled).

Continued on next page

Time Constants, Continued

Pitch

Use the \$JATT,PTAU command to adjust the level of responsiveness of the pitch measurement provided in the \$PSAT,HPR message. The default value of this constant is 0.5 seconds of smoothing.

Note: Increasing the time constant increases the level of pitch smoothing and increases lag.

Rate-of-Turn (ROT)

Use the \$JATT,HRTAU command to adjust the level of responsiveness of the ROT measurement provided in the \$GPROT message. The default value of this constant is 2.0 seconds of smoothing.

Note: Increasing the time constant increases the level of ROT smoothing.

Course-Over-Ground (COG)

Use the \$JATT,COGTAU command to adjust the level of responsiveness of the COG measurement provided in the \$GPVTG message. The default value of this constant is 0.0 seconds of smoothing.

Note: Increasing the time constant increases the level of COG smoothing.

COG is computed using only the primary GNSS antenna and its accuracy depends upon the speed of the vessel (noise is proportional to 1/speed).

This value is invalid when the vessel is stationary, as tiny movements due to calculation inaccuracies are not representative of a vessel's movement.

Speed

Use the \$JATT,SPDTAU command to adjust the level of responsiveness of the speed measurement provided in the \$GPVTG message. The default value of this parameter is 0.0 seconds of smoothing.

Note: Increasing the time constant increases the level of speed measurement smoothing.

Chapter 4: Operating the V123_V133

Overview

Introduction This section provides information on how to power and operate your V123_V133 receiver.

Contents

Topic	See Page
Powering the V123_V133	59
Beacon Operation	60
Alarm Functionality	61

Powering the V123_V133

Power connections

For best performance, use a clean and continuous power supply. The V123_V133 power supply features reverse polarity protection but will not operate with reverse polarity. See [Table B-4](#) for complete power specifications.

Note: This section refers to powering the unit via serial connection. To power the unit via NMEA 2000 connection, follow the standard procedure for powering up via NMEA 2000.

Before you power up the V123_V133 you must terminate the wires of the power cable as required. There are a variety of power connectors and terminals on the market from which to choose, depending on your specific requirements.

⚠ WARNING:
Do not apply a voltage higher than 36 VDC. This will damage the receiver and void the warranty.

To interface the V123_V133 power cable to the power source:

- Connect the red wire of the cable's power input to DC positive (+)
- Connect the black wire of the cable's power input to DC negative (-)

The V123_V133 starts when an acceptable voltage is applied to the power leads of the extension cable.

Electrical isolation

The V123_V133's power supply is isolated from the communication lines and the PC-ABS plastic enclosure isolates the electronics mechanically from the vessel (addressing the issue of vessel hull electrolysis).

Beacon Operation

V123_V133 beacon

Many marine authorities, such as coast guards, have installed networks of radio- beacons that broadcast DGNSS corrections to system users.

The dual channel beacon receiver in the V133 can operate in manual or automatic tuning mode, or, using database mode, will select the closest station in compliance with IEC61108-4 standards.

Alarm Functionality

Alarm signal There are two wires (24 AWG multi-strands) on the output cable that are used for the external alarm function. The color codes for the two wires are white and white/red stripe and are the output of a relay. When the receiver has heading, pins 13 and 14 have continuity. When the receiver loses heading, pins 13 and 14 do not have continuity. The receiver then outputs 4V of power between pins 14 and signal ground (pin 12), triggering the alarm.

Watchdog The watchdog is a timer controlled by the software which monitors heading loss. The watchdog software is compliant with IEC 60945.

Appendix A: Troubleshooting

Overview

Introduction

Appendix A provides troubleshooting for common problems.

Contents

Topic	See Page
Troubleshooting	63

Troubleshooting

Appendix A troubleshooting

Symptom	Possible Solution
Receiver fails to power	<ul style="list-style-type: none"> • Verify polarity of power leads • Check integrity of power cable connectors • Check power input voltage (9 to 36 VDC) • Check the voltage coming out of the connector at the end of the cable • Check current restrictions imposed by power source (minimum available should be > 1.0 A)
No data from V123_V133	<ul style="list-style-type: none"> • Check receiver power status to ensure the receiver is powered • Verify desired messages are activated (using PocketMax4 or \$JSHOW command in any terminal program) • Ensure the baud rate of the V123_V133 matches that of the receiving device • Check integrity and connectivity of power and data cable connections
Random data from V123_V133	<ul style="list-style-type: none"> • Verify the RTCM or binary messages are not output accidentally (send a \$JSHOW command) • Ensure the baud rate of the V123_V133 matches that of the remote device • The volume of data requested for output by the V123_V133 could be higher than the current baud rate supports.
No GNSS lock	<ul style="list-style-type: none"> • Verify the V123_V133 has a clear view of the sky • Use PocketMax4 to check how many satellites are in view and the SNR values

Continued on next page

Troubleshooting, Continued

Appendix A
troubleshooting
, continued

Symptom	Possible Solution
No SBAS lock	<ul style="list-style-type: none"> • Verify the V123_V133 has a clear view of the sky • Set SBAS mode to automatic with the \$JWAASPRN,AUTO command <div style="border: 1px solid black; padding: 5px; margin-top: 10px;"> <p>Note: SBAS lock is only possible if you are in an appropriate SBAS region; currently, there is limited SBAS availability in the southern hemisphere.</p> </div>
No Atlas	<ul style="list-style-type: none"> • First, check to see for an Atlas Basic subscription by sending \$JK,SHOW to see which commands are listed. Or, connect to PocketMax4, go to the About tab, and check the listed activations • Ensure you are tracking the correct Atlas satellite, or set the receiver to 'Auto-Tune' by sending \$JFREQ,AUTO

Continued on next page

Troubleshooting, Continued

Appendix A
troubleshooting
, continued

Symptom	Possible Solution
No heading or incorrect heading value	<ul style="list-style-type: none"> • Check CSEP value is constant without varying more than 1 cm (0.39 in)—larger variations may indicate a high multipath environment and require moving the receiver location • Heading is from primary GNSS antenna to secondary GNSS antenna, so the arrow on the underside of the V123_V133 is directed to the bow side • \$JATT,SEARCH command forces the V123_V133 to acquire a new heading solution (unless gyro is enabled) • Enable GYROAID to provide heading for up to three minutes during GNSS signal loss • Enable TILTAID to reduce heading search times • Monitor the number of satellites and SNR values for both antennas within PocketMax4—at least four satellites should have strong SNR values • The volume of data requested for output by the V123_V133 could be higher than the current baud rate supports.

Continued on next page

Troubleshooting, Continued

Appendix A
troubleshooting
, continued

Symptom	Possible Solution
No DGPS position in external RTCM mode	<ul style="list-style-type: none">• Verify the baud rate of the RTCM input port matches the baud rate of the external source• Verify the pinout between the RTCM source and the RTCM input port (transmit from the source must go to receive of the RTCM input port and grounds must be connected)• Ensure corrections are being transmitted to the correct port— using the \$JDIFF,PORTB command on Port A will cause the receiver to expect the corrections to be input through Port B

Appendix B: Technical Specifications

Technical Specifications

Introduction Appendix B provides the V123_V133 technical specifications, and the V123_V133 certification information.

Contents

Topic	See Page
V123_V133 Technical Specifications	68

V123_V133 Technical Specifications

V123_V133
technical
specifications

Table B-1: V123/ 133 sensor

Item	Specification
Receiver type	GNSS L1
Signals Received	GPS, GLONASS, BeiDou, Galileo, QZSS ³ , and Atlas
Channels	300
GPS sensitivity	-142 dBm
SBAS tracking	2-channel, parallel tracking
Update rate (position and heading)	10 Hz standard, optional 20 Hz (Non-I and 50 Hz
Position accuracy	1.2 m RMS (autonomous) 0.3 m RMS (SBAS) 0.3 m RMS (Atlas)
Heading accuracy (GNSS)	< 0.30° RMS
Heave accuracy (GNSS)	< 30cm RMS ¹
Pitch accuracy	< 1° RMS
Roll accuracy	< 1° RMS using accelerometer
Timing (1 PPS) accuracy	20 ns
Rate of turn	145°/s maximum
Cold start	< 40 s typical (no almanac or RTC)
Warm start	< 20 s typical (almanac and RTC)
Hot start	< 1 s typical (almanac, RTC, and position)
Heading fix	< 10 s typical (valid position)
Compass safe distance	75 cm (29.5 in) ²
Maximum speed	1,850 kph (999 kts)
Maximum altitude	18,288m (60,000 ft)

Continued on next page

V123_V133 Technical Specifications, Continued

V123_V133
technical
specifications,
continued

Table B-2: Beacon sensor (V133 only)

Item	Specification
Operating modes	Manual, automatic, and database
Compliance	IEC 61108-4 beacon standard

Table B-3: Communication

Item	Specification
Serial ports	RS-232 (full-duplex) RS-422 (1 full duplex, 1 half duplex)
Baud rates	4800, 9600, 19200, 38400, 57600, 115200
Correction I/O protocol	RTCM Atlas L-band
Data I/O protocol	NMEA 0183, NMEA 2000

Table B-4: Power

Item	Specification				
Input voltage	6 to 36 VDC				
Power consumption	<table border="1"> <thead> <tr> <th>V123</th> <th>V133</th> </tr> </thead> <tbody> <tr> <td>~ 4.3 W nominal</td> <td>~ 4.6 W nominal</td> </tr> </tbody> </table>	V123	V133	~ 4.3 W nominal	~ 4.6 W nominal
	V123	V133			
~ 4.3 W nominal	~ 4.6 W nominal				
Current consumption	<table border="1"> <thead> <tr> <th>V123</th> <th>V133</th> </tr> </thead> <tbody> <tr> <td>~ 0.36 A nominal</td> <td>~ 0.38 A nominal</td> </tr> </tbody> </table>	V123	V133	~ 0.36 A nominal	~ 0.38 A nominal
	V123	V133			
~ 0.36 A nominal	~ 0.38 A nominal				
Power isolation	Isolated to enclosure				
Reverse polarity protection	Yes				

Continued on next page

V123_V133 Technical Specifications, Continued

V123_V133
technical
specifications,
continued

Table B-5: Mechanical

Item	Specification	
Enclosure	Top Enclosure: ASA/PC Blend Bottom Enclosure: PC	
Dimensions	66.5 L x 20.8 W x 14.6 H (cm) 26.2 L x 8.2 W x 5.8 H (in)	
Weight	V123	V133
	2.1 kg (4.6 lb)	2.4 kg (5.4 lb)
Power/data connector	18-pin, environmentally sealed	

Table B-6: Environmental

Item	Specification
Operating temperature	-30°C to +70°C (-22°F to +158°F)
Storage temperature	-40°C to +85°C (-40°F to +185°F)
Humidity	95% non-condensing
Vibration	IEC 60945
EMC	CE (IEC 60945 Emissions and Immunity), RED (2014/53/EU)

Appendix C: Commands and Messages

Overview

Introduction

Appendix C contains the common commands and messages used by the V123_V133. Reference the following tables for sending and receiving commands and messages.

For information on message output rates refer to the [Hemisphere GNSS Technical Reference Manual](#).

Example message	Rate	Bytes	Bits in byte	Bits/sec
GPHDT	10	20	10	2000
GPROT	5	18	10	900
GPHDG	1	33	10	330
GPGGA	1	83	10	830
GPZDA	1	38	10	380
			Total	4440

Contents

Topic	See Page
Commands	73
Binary Messages	75
NMEA Messages	77
Index	94
TSP20181178146232_MapTitles	94
End User License Agreement	95
Warranty Notice	99

Commands

Commands The V123_V133 has a maximum baud rate of 115200.

Note: When selecting baud rate and message types, use the following formula and example to calculate the bits/sec for each message and then sum the results to determine the baud rate for your required data throughput.

Message length (bytes) * bits in byte = Bits/second
 (1 character = 1 byte, 8 bits = 1 byte, use 10 bits/byte to account for overhead)

Table C-1: Commands

Command	Description
\$GPMSK	Tune beacon to specific frequency
\$JAGE	Specify maximum DGPS (COAST) correction age (6 to 8100 seconds)
\$JAPP	Query or specify receiver application firmware
\$JASC	Specify ASCII messages to output to specific ports
\$JBAUD	Specify RS-232, RS-422 (output) communication rate
\$JBIN	Specify binary messages to output to specific ports (see Table 3-4)
\$JDIFF	Query or specify differential correction mode
\$JGEO	Query or specify SBAS for current location and SBAS satellites
\$JI	Query unit's serial number and firmware versions
\$JOFF	Turn off all data messages
\$JQUERY,GUIDE	Query accuracy suitability for navigation
\$JMODE,GPSONLY,YES	GPS only mode

Continued on next page

Commands, Continued

Commands,
continued

Table C-1: Commands (continued)

Command	Description
\$JMODE,GPSONLY,NO	Multi-GNSS mode
\$JRESET	<p>Reset unit's configuration to firmware defaults</p> <div style="border: 1px solid black; padding: 5px; margin: 5px 0;"> <p>Note: \$JRESET clears all parameters. For the V123_V133 you will have to issue the \$JATT, FLIPBRD,YES command to properly redefine the circuitry orientation inside the product once the receiver has reset. Failure to do so will cause radical heading behavior.</p> </div> <p>You can also issue the \$JRESET command with an optional field as follows:</p> <ul style="list-style-type: none"> • \$JRESET,ALL does everything \$JRESET does, plus it clears almanacs • \$JRESET,BOOT does everything \$JRESET,ALL does, plus clears use of the real-time clock at startup, clears use of backed-up ephemeris and almanacs, and reboots the receiver when done
\$JSAVE	Save session's configuration changes

Binary Messages

Binary messages

Table C-2 lists the Binary messages used by the V123_V133. To log raw binary data to convert to Rinex, turn on Bin 76 (GPS), Bin 66 (GLONASS), Bin 36 (BeiDou), or turn on Bin 16 (all constellations; required for Galileo).

Additionally, enable ephemeris messages: Bin 95 (GPS), Bin 65 (GLONASS), Bin 35 (BeiDou), and Bin 45 (Galileo).

Enable the time conversion messages: Bin 94 (GPS), Bin 34 (BeiDou), and Bin 44 (Galileo).

Table C-2: Binary messages

\$JBIN Message	Description
1	GNSS position
2	GPS DOPs
80	SBAS
93	SBAS ephemeris data
94	Ionosphere and UTC conversion parameters
95	Satellite ephemeris data
96	Code and carrier phase (not needed if using Bin 16, Bin 16 includes information for all constellations)
97	Processor statistics
98	Satellites and almanac
99	GPS diagnostics
16	All constellation code and phase observation data. Use Bin16 if you need Galileo code and carrier phase observation. Galileo does not have a separate message
34	BeiDou time conversion
35	BeiDou ephemeris information

Continued on next page

Binary Messages, Continued

Binary messages, continued

Table C-2: Binary messages (continued)

\$JBIN Message	Description
36	BeiDou code and carrier phase information (not needed if using Bin 16, Bin 16 includes information for all constellations)
44	Galileo time conversion
45	Galileo ephemeris
65	GLONASS ephemeris information
66	GLONASS code and carrier phase information (not needed if using Bin 16, Bin 16 includes information for all constellations)

NMEA Messages

V123_V133 **Table C-3: NMEA messages received based on a request**
NMEA received
messages

PGN	Description	Default Update Rate (msec)	Freq (Hz)
059392	ISO Acknowledgement Used to acknowledge the status of certain requests addressed to a specific ECU.	On Request	On Request
059904	ISO Request Request the transmission of a specific PGN, addressed or broadcast.	On Request	On Request
060928	ISO Address Claim Used to identify to other ECUs the address claimed by an ECU.	On Request	On Request
126996	Product Information NMEA 2000 database version supported, manufacturer's product code, NMEA 2000 certification level, Load Equivalency number, and other product- specific information.	On Request	On Request

Continued on next page

NMEA Messages, Continued

V123_V133 **Table C-3: NMEA messages received based on a request (continued)**
NMEA received
messages,
continued

PGN	Description	Default Update Rate (msec)	Freq (Hz)
126464	Receive/Transmit PGNs group function The Transmit / Receive PGN List Group type of function is defined by the first field.	On Request	On Request
129545	GNSS RAIM Output Used to provide the output from a GNSS receiver's Receiver Autonomous Integrity Monitoring (RAIM) process. The Integrity field value is based on the parameters set in PGN 129546 GNSS RAIM Settings.	On Request	On Request
129546	GNSS RAIM Settings Used to report the control parameters for a GNSS Receiver Autonomous Integrity Monitoring (RAIM) process.	On Request	On Request

Continued on next page

NMEA Messages, Continued

V123_V133 **Table C-3: NMEA transmitted messages**
NMEA
transmitted
messages

PGN	Description	Default Update Rate (msec)	Freq (Hz)
126992	System Time The purpose of this PGN is twofold: 1) To provide a regular transmission of UTC time and date, and 2) To provide synchronism for measurement data	1000	1
126993	Heartbeat Confirms a device is still present on the network.	60000	1/60
127250	Vessel Heading Heading sensor value with a flag for True or Magnetic. If the sensor value is Magnetic, the deviation field can be used to produce a Magnetic heading, and the variation field can be used to correct the Magnetic heading to produce a True heading.	100	10
127251	Rate of Turn Rate of change of heading.	100	10

Continued on next page

NMEA Messages, Continued

V123_V133
NMEA
transmitted
messages,
continued

Table C-3: NMEA transmitted messages (continued)

PGN	Description	Default Update Rate (msec)	Freq (Hz)
127257	<p>Altitude</p> <p>Provides a single transmission that describes the position of a vessel relative to both horizontal and vertical planes.</p> <p>Altitude can be used for vessel stabilization, vessel control and onboard platform stabilization.</p>	1000	1
127258	<p>Magnetic Variation</p> <p>Message for transmitting variation.</p> <p>The message contains a sequence number to synchronize other messages such as Heading or Course over Ground.</p> <p>The quality of service and age of service are provided to determine appropriate level of service if multiple transmissions exist.</p>	1000	1

Continued on next page

NMEA Messages, Continued

V123_V133
NMEA
transmitted
messages,
continued

Table C-3: NMEA transmitted messages (continued)

PGN	Description	Default Update Rate (msec)	Freq (Hz)
129025	<p>Position, Rapid Update</p> <p>Provides latitude and longitude referenced to WGS84.</p> <p>A single frame message (opposed to other PGNs that include latitude and longitude and are defined as fast or multi- packet), this PGN lends itself to more frequent transmission without using excessive bandwidth.</p>	100	10
129026	<p>COG & SOG, Rapid Update</p> <p>Single frame PGN that provides Course Over Ground (COG) and Speed Over Ground (SOG).</p>	250	4

Continued on next page

NMEA Messages, Continued

V123_V133
NMEA
transmitted
messages,
continued

Table C-3: NMEA transmitted messages (continued)

PGN	Description	Default Update Rate (msec)	Freq (Hz)
129027	<p>Position Delta, High Precision Rapid Update</p> <p>The 'Position Delta, High Precision Rapid Update' Parameter Group is for applications requiring high precision and very fast update rates for position data.</p> <p>This PGN provides delta position changes down to 1 mm with a delta time period accurate to 5 msec.</p>	100	10

Continued on next page

NMEA Messages, Continued

V123_V133
NMEA
transmitted
messages,
continued

Table C-3: NMEA transmitted messages (continued)

PGN	Description	Default Update Rate (msec)	Freq (Hz)
129028	<p>Altitude Delta, High Precision Rapid Update</p> <p>The 'Altitude Delta, High Precision Rapid Update' Parameter Group is intended for applications requiring high precision and fast update rates are needed for altitude and course over ground data.</p> <p>This PGN can provide delta altitude changes down to 1 millimeter, a change in direction as small as 0.0057°, and with a delta time period accurate to 5 msec.</p>	100	10

Continued on next page

NMEA Messages, Continued

V123_V133
NMEA
transmitted
messages,
continued

Table C-3: NMEA transmitted messages (continued)

PGN	Description	Default Update Rate (msec)	Freq (Hz)
129029	GNSS Position Data Conveys a comprehensive set of Global Navigation Satellite System (GNSS) parameters, including position information.	1000	1
129033	Time & Date Single transmission that provides UTC time, UTC Date, and Local Offset.	1000	1
129539	GNSS DOPs Provides a single transmission containing GNSS status and dilution of precision components (DOP) that indicate the contribution of satellite geometry to the overall positioning error. Three DOP parameters are reported: horizontal (HDOP), Vertical (VDOP), and time (TDOP).	1000	1

Continued on next page

NMEA Messages, Continued

V123_V133
NMEA
transmitted
messages,
continued

Table C-3: NMEA transmitted messages (continued)

PGN	Description	Default Update Rate (msec)	Freq (Hz)
129540	<p>GNSS Sats in View</p> <p>GNSS information on current satellites in view tagged by sequence ID.</p> <p>Information includes PRN, elevation, azimuth, SNR, defines the number of satellites; defines the satellite number and the information.</p>	1000	1

Continued on next page

NMEA Messages, Continued

V123_V133 **Table C-4 NMEA 0183 and other messages**
NMEA 0183 and
other messages

In Table C-4 the Info Type value is one of the following:

- P = Position
- V = Velocity, Time
- H = Heading, Attitude S = Sets, Stats, Quality

Message	Info Type	Max Output Rate	Description	IEC Approved Message
\$GPDTM	P	1 Hz	Datum reference	Yes
\$GPGGA	P	50 Hz	GPS position and fix data	Yes
\$GPGLL	P	50 Hz	Geographic position - lat/long	Yes
\$GPGNS	P	50 Hz	GNSS position and fix data	Yes
\$GPGRS	S	1 Hz	GNSS range residual (RAIM)	Yes
\$GPGSA	S	1 Hz	GNSS DOP and active satellites	Yes
\$GPGST	S	1 Hz	GNSS pseudo range error statistics and position accuracy	Yes
\$GPGSV	S	1 Hz	GNSS satellites in view	Yes
*\$GPHDG	H	50 Hz	Provides magnetic deviation and variation for calculating magnetic or true heading	Yes

Continued on next page

NMEA Messages, Continued

V123_V133 **Table C-4 NMEA 0183 and other messages (continued)**
NMEA 0183 and
other messages,
 continued

Message	Info Type	Max Output Rate	Description	IEC Approved Message
*\$GPHDM	H	50 Hz	Magnetic heading (based on GNSS-derived heading and magnetic declination)	No
*\$GPHDT	H	50 Hz	GNSS-derived true heading	Yes
\$GPHEV	H	50 Hz	Heave value (in meters)	Yes
\$GPRMC	P	50 Hz	Recommended minimum specific GNSS data	Yes
*\$GPROT	H	50 Hz	GNSS-derived rate of turn (ROT)	Yes
\$GPRRE	S	1 Hz	Range residual and estimated position error	Yes
\$GPVTG	V	50 Hz	COG and ground speed	Yes
\$GPZDA	V	50 Hz	Time and date	Yes
\$HEACK	S	1 Hz	Acknowledge alarm	Yes
\$HEACN	S	1 Hz	Alert command	Yes
\$HEALF	S	1 Hz	Alert sentence	Yes
\$HEALC	S	1 Hz	Cyclic alert list	Yes
\$HEALR	S	1 Hz	Set alarm state	Yes
\$HEHBT	S	1 Hz	Heartbeat supervision sentence	Yes

Continued on next page

NMEA Messages, Continued

V123_V133 **Table C-4 NMEA 0183 and other messages (continued)**
NMEA 0183 and
other messages,
 continued

Message	Info Type	Max Output Rate	Description	IEC Approved Message
\$HETHS	H	50 Hz	True heading and status	Yes
\$PASHR	H	50 Hz	Time, heading, roll, and pitch data in one message	No
\$PSAT,GBS	S	1 Hz	Satellite fault detection (RAIM)	Yes
\$PSAT,HPR	H	50 Hz	Proprietary NMEA message that provides heading, pitch, roll, and time in single message	No
\$PSAT,INTLT	H	1 Hz	Proprietary NMEA message that provides the pitch and roll measurements from the internal inclinometers (in degrees)	Yes
\$RD1	S	1 Hz	SBAS diagnostic information	Yes
\$TSS1	H	50 Hz	Heading, pitch, roll, and heave message in the commonly used TSS1 message format	No

Continued on next page

NMEA Messages, Continued

V123_V133 **Table C-4 NMEA 0183 and other messages (continued)**
NMEA 0183 and
other messages,
continued

Notes:

- The GP of the message is the talker ID
- You can change the message header for the HDG, HDM, HDT, and ROT messages to either GP or HE uses the \$JATT,NMEAHE command
 - To preface these messages with GP, issue the following command:
\$JATT,NMEAHE,0<CR><LF>
 - To preface these messages with HE, issue the following command:
\$JATT,NMEAHE,1<CR><LF>
- GPGRS, GPGSA, GPGST, and GPGSV support external integrity checking; synchronize with corresponding fix data (GPGGA or GPGNS)
- For information on outputting roll, pitch, and heave data in one message refer to the [Hemisphere GNSS Technical Reference Manual](#)
- HBT is sent every 30 seconds
- After 60 seconds, a heading loss warning is escalated to an alarm
- Silence timeout is 30 seconds
- THS message definition (from IEC61162-1 ed5): THS – True heading and status
- \$HETHS,x.x,a*hh<CR><LF>
- x.x Heading, degrees true
- a Mode indicator (This field should not be null): A = Autonomous, E = Estimated (dead reckoning), V = Data not valid (including standby)
- 50Hz output requires 50Hz-capable firmware plus 50Hz activation

For more information on the \$JATT,NMEAHE command refer to the [Hemisphere GNSS Technical Reference Manual](#).

Continued on next page

NMEA Messages, Continued

V123_V133 **Table C-5: Parameters specific to the \$JATT command**
Parameters
specific to the
\$JATT command

Parameter	Description	Query	Specify
BALERT	Enables Bridge Alert Management Functionality	X	X
COGTAU	Set/query COG time constant (0.0 to 3600.0 sec)	X	X
CSEP	Query antenna separation	X	
EXACT	Enable/disable internal filter reliance on the entered antenna separation	X	X
FLIPBRD	Turn the flip feature on/off	X	X
GYROAID	Enable/disable gyro	X	X
HBIAS	Set/query heading bias (-180.0° to 180.0°)	X	X
HELP	Show the available commands for GNSS heading operation and status	X	
HIGHMP	Set/query the high multipath setting for use in poor GNSS environments	X	X

Continued on next page

NMEA Messages, Continued

V123_V133
Parameters
specific to the
\$JATT
command,
continued

Table C-5: Parameters specific to the \$JATT command (continued)

Parameter	Description	Query	Specify
HRTAU	Set/query ROT time constant (0.0 to 3600.0 sec)	X	X
HTAU	Set/query heading time constant (0.0 to 3600.0 sec)	X	X
LEVEL	Enable/disable level operation	X	X
MSEP	Manually set or query antenna separation	X	X
NEGILT	Enable/disable negative tilt	X	X
NMEAHE	Change the HDG, HDM, HDT, and ROT message headers between GP and HE	X	X
PBIAS	Set/query pitch/roll bias (-15.0° to 15.0°)	X	X
PTAU	Set/query pitch time constant (0.0 to 3600.0 sec)	X	X

Continued on next page

NMEA Messages, Continued

V123_V133
Parameters
specific to the
\$JATT
command,
continued

Table C-5: Parameters specific to the \$JATT command (continued)

Parameter	Description	Query	Specify
ROLL	Configure for roll or pitch GNSS orientation	X	X
SEARCH	Force a new GNSS heading search		X
SPDTAU	Set/query speed time constant (0.0 to 3600.0 sec)	X	X

Continued on next page

NMEA Messages, Continued

V123_V133
Parameters
specific to the
\$JATT
command,
continued

Table C-5: Parameters specific to the \$JATT command (continued)

Parameter	Description	Query	Specify
SUMMARY	Display a summary of the current Crescent Vector settings	X	
TILTAID	Enable/disable accelerometer, pre-calibrated	X	X
TILTCAL	Calibrate accelerometers		X

Index

Activate Loader	23	NMEA 2000 adapter	15, 37, 38, 39, 45, 47
Activation	6	Pitch.....	13, 57, 68
Atlas	6, 12, 49, 52	Pole-mount	32
Base Station	6	Port A.....	43, 44, 48, 66
beacon	10, 11, 13, 27, 50, 60, 69, 73	Port B.....	43, 44, 48, 66
BeiDou	6	Positioning accuracy	12
Bracket-mount	32	Positioning sustainability	12
cable length.....	26, 47	Program Type	22
COAST	11, 73	radar mounting plate.....	40
course-over-ground	56	Rate-of-Turn	56
Course-Over-Ground (COG)	57	Rate-of-Turn (ROT)	56, 57
Crescent Vector.....	9, 10, 93	RightArm.....	20
CSEP value.....	65	RTCM	50, 63, 66, 69
DGPS/DGNSS.....	6	RTK.....	6, 12, 49, 53, 55, 68
Differential Corrections.....	6	SBAS.....	11, 13, 49, 50, 64, 68, 73, 75, 88
Elevation Mask.....	6	Speed.....	57, 81
environmental.....	26, 29	THD.....	61
firmware	20, 21, 22, 23, 24, 43	Tilt aiding	53
Firmware.....	20	tilt sensors	10, 53
Flush-mount	32	TILTAID	65, 93
GPS.....	6	VHF interference.....	28
gyro	54, 56, 65, 90	VHF marine radio.....	28
Heading.....	79, 80	watchdog.....	61
HPR values	30	WebUI.....	20
NMEA.....	77		

End User License Agreement

End User license agreement

IMPORTANT - This is an agreement (the "**Agreement**") between you, the end purchaser ("**Licensee**") and Hemisphere GNSS Inc. ("**Hemisphere**") which permits Licensee to use the Hemisphere software (the "**Software**") that accompanies this Agreement. This Software may be licensed on a standalone basis or may be embedded in a Product. Please read and ensure that you understand this Agreement before installing or using the Software Update or using a Product.

In this agreement any product that has Software embedded in it at the time of sale to the Licensee shall be referred to as a "**Product**". As well, in this Agreement, the use of a Product shall be deemed to be use of the Software which is embedded in the Product.

BY INSTALLING OR USING THE SOFTWARE UPDATE OR THE PRODUCT, LICENSEE THEREBY AGREES TO BE LEGALLY BOUND BY THE TERMS OF THIS AGREEMENT. IF YOU DO NOT AGREE TO THESE TERMS, (I) DO NOT INSTALL OR USE THE SOFTWARE, AND (II) IF YOU ARE INSTALLING AN UPDATE TO THE SOFTWARE, DO NOT INSTALL THE UPDATE AND PROMPTLY DESTROY IT.

HEMISPHERE PROVIDES LIMITED WARRANTIES IN RELATION TO THE SOFTWARE. AS WELL, THOSE WHO USE THE EMBEDDED SOFTWARE DO SO AT THEIR OWN RISK. YOU SHOULD UNDERSTAND THE IMPORTANCE OF THESE AND OTHER LIMITATIONS SET OUT IN THIS AGREEMENT BEFORE INSTALLING OR USING THE SOFTWARE OR THE PRODUCT.

1. **LICENSE.** Hemisphere hereby grants to Licensee a non-transferable and non-exclusive license to use the Software as embedded in a Product and all Updates (collectively the "**Software**"), solely in binary executable form.
2. **RESTRICTIONS ON USE.** Licensee agrees that Licensee and its employees will not directly or indirectly, in any manner whatsoever:
 - a. install or use more copies of the Software than the number of copies that have been licensed;
 - b. use or install the Software in connection with any product other than the Product the Software was intended to be used or installed on as set out in the documentation that accompanies the Software.
 - c. copy any of the Software or any written materials for any purpose except as part of Licensee's normal backup processes;
 - d. modify or create derivative works based on the Software;
 - e. sub-license, rent, lease, loan or distribute the Software;
 - f. permit any third party to use the Software;
 - g. use or operate Product for the benefit of any third party in any type of service outsourcing, application service, provider service or service bureau capacity;
 - h. reverse engineer, decompile or disassemble the Software or otherwise reduce it to a human perceivable form;
 - i. Assign this Agreement or sell or otherwise transfer the Software to any other party except as part of the sale or transfer of the whole Product.
3. **UPDATES.** At Hemisphere's discretion Hemisphere may make Updates available to Licensee. An update ("**Update**") means any update to the Software that is made available to Licensee including error corrections, enhancements and other modifications. Licensee may access, download and install Updates during the Warranty Period only. All Updates that Licensee downloads, installs or uses shall be deemed to be Software and subject to this Agreement. Hemisphere reserves the right to modify the Product without any obligation to notify, supply or install any improvements or alterations to existing Software.
4. **SUPPORT.** Hemisphere may make available directly or through its authorized dealers telephone and email support for the Software. Contact Hemisphere to find the authorized dealer near you. As well, Hemisphere may make available user and technical documentation regarding the Software. Hemisphere reserves the right to reduce and limit access to such support at anytime.

Continued on next page

End User License Agreement, Continued

End User license agreement, continued

5. **BACKUPS AND RECOVERY.** Licensee shall back-up all data used, created or stored by the Software on a regular basis as necessary to enable proper recovery of the data and related systems and processes in the event of a malfunction in the Software or any loss or corruption of data caused by the Software. Licensee shall assume all risks of loss or damage for any failure to comply with the foregoing.
6. **OWNERSHIP.** Hemisphere and its suppliers own all rights, title and interest in and to the Software and related materials, including all intellectual property rights. The Software is licensed to Licensee, not sold.
7. **TRADEMARKS.** "Hemisphere GNSS", "Crescent", "Eclipse" and the associated logos are trademarks of Hemisphere. Other trademarks are the property of their respective owners. Licensee may not use any of these trademarks without the consent of their respective owners.
8. **LIMITED WARRANTY.** Hemisphere warrants solely to the Licensee, subject to the exclusions and procedures set forth herein below, that for a period of one (1) year from the original date of purchase of the Product in which it is embedded (the "Warranty Period"), the Software, under normal use and maintenance, will conform in all material respects to the documentation provided with the Software and any media will be free of defects in materials and workmanship. For any Update, Hemisphere warrants, for 90 days from performance or delivery, or for the balance of the original Warranty Period, whichever is greater, that the Update, under normal use and maintenance, will conform in all material respects to the documentation provided with the Update and any media will be free of defects in materials and workmanship. Notwithstanding the foregoing, Hemisphere does not warrant that the Software will meet Licensee's requirements or that its operation will be error free.
9. **WARRANTY EXCLUSIONS.** The warranty set forth in Section (8) will not apply to any deficiencies caused by (a) the Product not being used as described in the documentation supplied to Licensee, (b) the Software having been altered, modified or converted in any way by anyone other than Hemisphere approved by Hemisphere, (c) any malfunction of Licensee's equipment or other software, or (d) damage occurring in transit or due to any accident, abuse, misuse, improper installation, lightning (or other electrical discharge) or neglect other than that caused by Hemisphere. Hemisphere GNSS does not warrant or guarantee the precision or accuracy of positions obtained when using the Software (whether standalone or embedded in a Product). The Product and the Software is not intended and should not be used as the primary means of navigation or for use in safety of life applications. The potential positioning and navigation accuracy obtainable with the Software as stated in the Product or Software documentation serves to provide only an estimate of achievable accuracy based on specifications provided by the US Department of Defense for GPS positioning and DGPS service provider performance specifications, where applicable.
10. **WARRANTY DISCLAIMER.** EXCEPT AS EXPRESSLY SET OUT IN THIS AGREEMENT, HEMISPHERE MAKES NO REPRESENTATION, WARRANTY OR CONDITION OF ANY KIND TO LICENSEE, WHETHER VERBAL OR WRITTEN AND HEREBY DISCLAIMS ALL REPRESENTATIONS, WARRANTIES AND CONDITIONS OF ANY KIND INCLUDING FITNESS FOR A PARTICULAR PURPOSE, MERCHANTABILITY, ACCURACY, RELIABILITY OR THAT THE USE OF THE SOFTWARE WILL BE UNINTERRUPTED OR ERROR-FREE AND HEREBY DISCLAIMS ALL REPRESENTATIONS, WARRANTIES AND CONDITIONS ARISING AS A RESULT OF CUSTOM, USAGE OR TRADE AND THOSE ARISING UNDER STATUTE.
11. **LIMITS ON WARRANTY DISCLAIMER.** Some jurisdictions do not allow the exclusion of implied warranties or conditions, so some of the above exclusions may not apply to Licensee. In that case, any implied warranties or conditions which would then otherwise arise will be limited in duration to ninety (90) days from the date of the license of the Software or the purchase of the Product. The warranties given herein give Licensee specific legal rights and Licensee may have other rights which may vary from jurisdiction to jurisdiction.
12. **CHANGE TO WARRANTY.** No employee or agent of Hemisphere is authorized to change the warranty provided or the limitation or disclaimer of warranty provisions. All such changes will only be effective if pursuant to a separate agreement signed by senior officers of the respective parties.

Continued on next page

End User License Agreement, Continued

End User license agreement, continued

13. **WARRANTY CLAIM.** In the event Licensee has a warranty claim Licensee must first check for and install all Updates that are made available. The warranty will not otherwise be honored. Proof of purchase may be required. Hemisphere does not honor claims asserted after the end of the Warranty Period.
14. **LICENSEE REMEDIES.** In all cases which involve a failure of the Software to conform in any material respect to the documentation during the Warranty Period or a breach of a warranty, Hemisphere's sole obligation and liability, and Licensee's sole and exclusive remedy, is for Hemisphere, at Hemisphere's option, to (a) repair the Software, (b) replace the Software with software conforming to the documentation, or (c) if Hemisphere is unable, on a reasonable commercial basis, to repair the Software or to replace the Software with conforming software within ninety (90) days, to terminate this Agreement and thereafter Licensee shall cease using the Software. Hemisphere will also issue a refund for the price paid by Licensee less an amount on account of amortization, calculated on a straight-line basis over a deemed useful life of three (3) years.
15. **LIMITATION OF LIABILITY.** IN NO EVENT WILL HEMISPHERE BE LIABLE TO LICENSEE FOR ANY INCIDENTAL, CONSEQUENTIAL, SPECIAL OR INDIRECT DAMAGES INCLUDING ARISING IN RELATION TO ANY LOSS OF DATA, INCOME, REVENUE, GOODWILL OR ANTICIPATED SAVINGS EVEN IF HEMISPHERE HAS BEEN INFORMED OF THE POSSIBILITY OF SUCH LOSS OR DAMAGE. FURTHER, IN NO EVENT WILL HEMISPHERE'S TOTAL CUMULATIVE LIABILITY HEREUNDER, FROM ALL CAUSES OF ACTION OF ANY KIND, EXCEED THE TOTAL AMOUNT PAID BY LICENSEE TO HEMISPHERE TO PURCHASE THE PRODUCT. THIS LIMITATION AND EXCLUSION APPLIES IRRESPECTIVE OF THE CAUSE OF ACTION, INCLUDING BUT NOT LIMITED TO BREACH OF CONTRACT, NEGLIGENCE, STRICT LIABILITY, TORT, BREACH OF WARRANTY, MISREPRESENTATION OR ANY OTHER LEGAL THEORY AND WILL SURVIVE A FUNDAMENTAL BREACH.
16. **LIMITS ON LIMITATION OF LIABILITY.** Some jurisdictions do not allow for the limitation or exclusion of liability for incidental or consequential damages, so the above limitation or exclusion may not apply to Licensee and Licensee may also have other legal rights which may vary from jurisdiction to jurisdiction.
17. **BASIS OF BARGAIN.** Licensee agrees and acknowledges that Hemisphere has set its prices and the parties have entered into this Agreement in reliance on the limited warranties, warranty disclaimers and limitations of liability set forth herein, that the same reflect an agreed-to allocation of risk between the parties (including the risk that a remedy may fail of its essential purpose and cause consequential loss), and that the same forms an essential basis of the bargain between the parties. Licensee agrees and acknowledges that Hemisphere would not have been able to sell the Product at the amount charged on an economic basis without such limitations.
18. **PROPRIETARY RIGHTS INDEMNITY.** Hemisphere shall indemnify, defend and hold harmless Licensee from and against any and all actions, claims, demands, proceedings, liabilities, direct damages, judgments, settlements, fines, penalties, costs and expenses, including royalties and attorneys' fees and related costs, in connection with or arising out of any actual infringement of any third party patent, copyright or other intellectual property right by the Software or by its use, in accordance with this Agreement and documentation, PROVIDED THAT: (a) Hemisphere has the right to assume full control over any action, claim, demand or proceeding, (b) Licensee shall promptly notify Hemisphere of any such action, claim, demand, or proceeding, and (c) Licensee shall give Hemisphere such reasonable assistance and tangible material as is reasonably available to Licensee for the defense of the action, claim, demand or proceeding. Licensee shall not settle or compromise any of same for which Hemisphere has agreed to assume responsibility without Hemisphere's prior written consent. Licensee may, at its sole cost and expense, retain separate counsel from the counsel utilized or retained by Hemisphere. 19. **INFRINGEMENT.** If use of the Software may be enjoined due to a claim of infringement by a third party then, at its sole discretion and expense, Hemisphere may do one of the following: (a) negotiate a license or other agreement so that the Product is no longer subject to such a potential claim, (b) modify the Product so that it becomes non-infringing, provided such modification can be accomplished without materially affecting the performance and functionality of the Product,

Continued on next page

End User License Agreement, Continued

End User license agreement, continued

- (c) replace the Software, or the Product, with non-infringing software, or product, of equal or better performance and quality, or (d) if none of the foregoing can be done on a commercially reasonable basis, terminate this license and Licensee shall stop using the Product and Hemisphere shall refund the price paid by Licensee less an amount on account of amortization, calculated on a straight-line basis over a deemed useful life of three (3) years.
19. The foregoing sets out the entire liability of Hemisphere and the sole obligations of Hemisphere to Licensee in respect of any claim that the Software or its use infringes any third party rights.
20. **INDEMNIFICATION.** Except in relation to an infringement action, Licensee shall indemnify and hold Hemisphere harmless from any and all claims, damages, losses, liabilities, costs and expenses (including reasonable fees of lawyers and other professionals) arising out of or in connection with Licensee's use of the Product, whether direct or indirect, including without limiting the foregoing, loss of data, loss of profit or business interruption. **TERMINATION.** Licensee may terminate this Agreement at any time without cause. Hemisphere may terminate this Agreement on 30 days notice to Licensee if Licensee fails to materially comply with each provision of this Agreement unless such default is cured within the 30 days. Any such termination by a party shall be in addition to and without prejudice to such rights and remedies as may be available, including injunction and other equitable remedies. Upon receipt by Licensee of written notice of termination from Hemisphere or termination by Licensee, Licensee shall at the end of any notice period (a) cease using the Software; and (b) return to Hemisphere (or destroy and provide a certificate of a Senior Officer attesting to such destruction) the Software and all related material and any magnetic or optical media provided to Licensee. The provisions of Sections 6), 7), 8), 9), 10), 15), 21), 26) and 27) herein shall survive the expiration or termination of this Agreement for any reason.
21. **EXPORT RESTRICTIONS.** Licensee agrees that Licensee will comply with all export control legislation of Canada, the United States, Australia and any other applicable country's laws and regulations, whether under the Arms Export Control Act, the International Traffic in Arms Regulations, the Export Administration Regulations, the regulations of the United States Departments of Commerce, State, and Treasury, or otherwise as well as the export control legislation of all other countries.
22. **PRODUCT COMPONENTS.** The Product may contain third party components. Those third party components may be subject to additional terms and conditions. Licensee is required to agree to those terms and conditions in order to use the Product.
23. **FORCE MAJEURE EVENT.** Neither party will have the right to claim damages as a result of the other's inability to perform or any delay in performance due to unforeseeable circumstances beyond its reasonable control, such as labor disputes, strikes, lockouts, war, riot, insurrection, epidemic, Internet virus attack, Internet failure, supplier failure, act of God, or governmental action not the fault of the non-performing party.
24. **FORUM FOR DISPUTES.** The parties agree that the courts located in Calgary, Alberta, Canada and the courts of appeal there from will have exclusive jurisdiction to resolve any disputes between Licensee and Hemisphere concerning this Agreement or Licensee's use or inability to use the Software and the parties hereby irrevocably agree to attorn to the jurisdiction of those courts. Notwithstanding the foregoing, either party may apply to any court of competent jurisdiction for injunctive relief.
25. **APPLICABLE LAW.** This Agreement shall be governed by the laws of the Province of Alberta, Canada, exclusive of any of its choice of law and conflicts of law jurisprudence.
26. **CISG.** The United Nations Convention on Contracts for the International Sale of Goods will not apply to this Agreement or any transaction hereunder.

GENERAL. This is the entire agreement between Licensee and Hemisphere relating to the Product and Licensee's use of the same, and supersedes all prior, collateral or contemporaneous oral or written representations, warranties or agreements regarding the same. No amendment to or modification of this Agreement will be binding unless in writing and signed by duly authorized representatives of the parties. Any and all terms and conditions set out in any correspondence between the parties or set out in a purchase order which are different from or in addition to the terms and conditions set forth herein, shall have no application and no written notice of same shall be required. In the event that one or more of the provisions of this Agreement is found to be illegal or unenforceable, this Agreement shall not be rendered inoperative but the remaining provisions shall continue in full force and effect.

Warranty Notice

Warranty notice

COVERED PRODUCTS: This warranty covers all products manufactured by Hemisphere GNSS and purchased by the end purchaser (the "Products"), unless otherwise specifically and expressly agreed in writing by Hemisphere GNSS. **LIMITED WARRANTY:** Hemisphere GNSS warrants solely to the end purchaser of the Products, subject to the exclusions and procedures set forth below, that the Products sold to such end purchaser and its internal components shall be free, under normal use and maintenance, from defects in materials, and workmanship and will substantially conform to Hemisphere GNSS's applicable specifications for the Product, for a period of 12 months from delivery of such Product to such end purchaser (the "Warranty Period"). Repairs and replacement components for the Products are warranted, subject to the exclusions and procedures set forth below, to be free, under normal use and maintenance, from defects in material and workmanship, and will substantially conform to Hemisphere GNSS's applicable specifications for the Product, for 90 days from performance or delivery, or for the balance of the original Warranty Period, whichever is greater.

EXCLUSION OF ALL OTHER WARRANTIES. The LIMITED WARRANTY shall apply only if the Product is properly and correctly installed, configured, interfaced, maintained, stored, and operated in accordance with Hemisphere GNSS relevant User's Manual and Specifications, AND the Product is not modified or misused. The Product is provided "AS IS" and the implied warranties of MERCHANTABILITY and FITNESS FOR A PARTICULAR PURPOSE and ALL OTHER WARRANTIES, express, implied or arising by statute, by course of dealing or by trade usage, in connection with the design, sale, installation, service or use of any products or any component thereof, are EXCLUDED from this transaction and shall not apply to the Product. The LIMITED WARRANTY is IN LIEU OF any other warranty, express or implied, including but not limited to, any warranty of MERCHANTABILITY or FITNESS FOR A PARTICULAR PURPOSE, title, and non-infringement.

LIMITATION OF REMEDIES. The purchaser's EXCLUSIVE REMEDY against Hemisphere GNSS shall be, at Hemisphere GNSS's option, the repair or replacement of any defective Product or components thereof. The purchaser shall notify Hemisphere GNSS or a Hemisphere GNSS's approved service center immediately of any defect. Repairs shall be made through a Hemisphere GNSS approved service center only. Repair, modification or service of Hemisphere GNSS products by any party other than a Hemisphere GNSS approved service center shall render this warranty null and void. The remedy in this paragraph shall only be applied in the event that the Product is properly and correctly installed, configured, interfaced, maintained, stored, and operated in accordance with Hemisphere GNSS's relevant User's Manual and Specifications, AND the Product is not modified or misused. NO OTHER REMEDY (INCLUDING, BUT NOT LIMITED TO, SPECIAL, INDIRECT, INCIDENTAL, CONSEQUENTIAL OR CONTINGENT DAMAGES FOR LOST PROFITS, LOST SALES, INJURY TO PERSON OR PROPERTY, OR ANY OTHER INCIDENTAL OR CONSEQUENTIAL LOSS) SHALL BE AVAILABLE

TO PURCHASER, even if Hemisphere GNSS has been advised of the possibility of such damages. Without limiting the foregoing, Hemisphere GNSS shall not be liable for any damages of any kind resulting from installation, use, quality, performance or accuracy of any Product.

HEMISPHERE IS NOT RESPONSIBLE FOR PURCHASER'S NEGLIGENCE OR UNAUTHORIZED USES OF THE PRODUCT. IN NO EVENT SHALL Hemisphere GNSS BE IN ANY WAY RESPONSIBLE FOR ANY DAMAGES RESULTING FROM PURCHASER'S OWN NEGLIGENCE, OR FROM OPERATION OF THE PRODUCT IN ANY WAY OTHER THAN AS SPECIFIED IN Hemisphere GNSS's RELEVANT USER'S MANUAL AND SPECIFICATIONS. Hemisphere GNSS is NOT RESPONSIBLE for defects or performance problems resulting from (1) misuse, abuse, improper installation, neglect of Product; (2) the utilization of the Product with hardware or software products, information, data, systems, interfaces or devices not made, supplied or specified by Hemisphere GNSS; (3) the operation of the Product under any specification other than, or in addition to, the specifications set forth in Hemisphere GNSS's relevant User's Manual and Specifications; (4) damage caused by accident or natural events, such as lightning (or other electrical discharge) or fresh/ salt water immersion of Product; (5) damage occurring in transit; (6) normal wear and tear; or (7) the operation or failure of operation of any satellite-based positioning system or differential correction service; or the availability or performance of any satellite-based positioning signal or differential correction signal.

THE PURCHASER IS RESPONSIBLE FOR OPERATING THE VEHICLE SAFELY. The purchaser is solely responsible for the safe operation of the vehicle used in connection with the Product, and for maintaining proper system control settings. UNSAFE DRIVING OR SYSTEM CONTROL SETTINGS CAN RESULT IN PROPERTY DAMAGE, INJURY, OR DEATH.

Continued on next page

Warranty Notice, Continued

Warranty notice, continued

The purchaser is solely responsible for his/her safety and for the safety of others. The purchaser is solely responsible for maintaining control of the automated steering system at all times. THE PURCHASER IS SOLELY RESPONSIBLE FOR ENSURING THE PRODUCT IS PROPERLY AND CORRECTLY INSTALLED, CONFIGURED, INTERFACED, MAINTAINED, STORED, AND OPERATED IN ACCORDANCE WITH Hemisphere GNSS's RELEVANT USER'S MANUAL AND SPECIFICATIONS. Hemisphere GNSS does not warrant or guarantee the positioning and navigation precision or accuracy obtained when using Products. Products are not intended for primary navigation or for use in safety of life applications. The potential accuracy of Products as stated in Hemisphere GNSS literature and/or Product specifications serves to provide only an estimate of achievable accuracy based on performance specifications provided by the satellite service operator (i.e. US Department of Defense in the case of GPS and differential correction service provider. Hemisphere GNSS reserves the right to modify Products without any obligation to notify, supply or install any improvements or alterations to existing Products.

GOVERNING LAW. This agreement and any disputes relating to, concerning or based upon the Product shall be governed by and interpreted in accordance with the laws of the State of Arizona.

OBTAINING WARRANTY SERVICE. In order to obtain warranty service, the end purchaser must bring the Product to a Hemisphere GNSS approved service center along with the end purchaser's proof of purchase. Hemisphere GNSS does not warrant claims asserted after the end of the warranty period. For any questions regarding warranty service or to obtain information regarding the location of any of Hemisphere GNSS approved service center, contact Hemisphere GNSS at the following address:

Hemisphere GNSS

8515 E. Anderson Drive Scottsdale, AZ 85255, USA

Phone: +1-480-348-6380

Fax: +1-480-270-5070

TECHSUPPORT@HGNSS.COM

WWW.HGNSS.COM



Hemisphere GNSS Inc.
8515 East Anderson Drive, Suite A
Scottsdale, Arizona, US 85255
Phone: 480-348-6380
Fax: 480-270-5070
PRECISION@HGNSS.COM
WWW.HGNSS.COM